

COMPREHENSIVE SERVICES

We offer competitive repair and calibration services, as well as easily accessible documentation and free downloadable resources.

SELL YOUR SURPLUS

We buy new, used, decommissioned, and surplus parts from every NI series. We work out the best solution to suit your individual needs.

 Sell For Cash  Get Credit  Receive a Trade-In Deal

OBSOLETE NI HARDWARE IN STOCK & READY TO SHIP

We stock **New**, **New Surplus**, **Refurbished**, and **Reconditioned** NI Hardware.



Bridging the gap between the manufacturer and your legacy test system.

 1-800-915-6216

 www.apexwaves.com

 sales@apexwaves.com

All trademarks, brands, and brand names are the property of their respective owners.

Request a Quote

 **CLICK HERE**

SCXI-1326

SCXI-1163R

User Manual

32-Channel Optically Isolated Solid-State Relay Module

July 1994 Edition

Part Number 320677A-01

**© Copyright 1994 National Instruments Corporation.
All Rights Reserved.**

National Instruments Corporate Headquarters

6504 Bridge Point Parkway

Austin, TX 78730-5039

(512) 794-0100

Technical support fax: (800) 328-2203

(512) 794-5678

Branch Offices:

Australia (03) 879 9422, Austria (0662) 435986, Belgium 02/757.00.20, Canada (Ontario) (519) 622-9310,
Canada (Québec) (514) 694-8521, Denmark 45 76 26 00, Finland (90) 527 2321, France (1) 48 14 24 24,
Germany 089/741 31 30, Italy 02/48301892, Japan (03) 3788-1921, Netherlands 03480-33466, Norway 32-848400,
Spain (91) 640 0085, Sweden 08-730 49 70, Switzerland 056/20 51 51, U.K. 0635 523545

Limited Warranty

The SCXI-1163R is warranted against defects in materials and workmanship for a period of one year from the date of shipment, as evidenced by receipts or other documentation. National Instruments will, at its option, repair or replace equipment that proves to be defective during the warranty period. This warranty includes parts and labor.

A Return Material Authorization (RMA) number must be obtained from the factory and clearly marked on the outside of the package before any equipment will be accepted for warranty work. National Instruments will pay the shipping costs of returning to the owner parts which are covered by warranty.

National Instruments believes that the information in this manual is accurate. The document has been carefully reviewed for technical accuracy. In the event that technical or typographical errors exist, National Instruments reserves the right to make changes to subsequent editions of this document without prior notice to holders of this edition. The reader should consult National Instruments if errors are suspected. In no event shall National Instruments be liable for any damages arising out of or related to this document or the information contained in it.

EXCEPT AS SPECIFIED HEREIN, NATIONAL INSTRUMENTS MAKES NO WARRANTIES, EXPRESS OR IMPLIED, AND SPECIFICALLY DISCLAIMS ANY WARRANTY OF MERCHANTABILITY OR FITNESS FOR A PARTICULAR PURPOSE. CUSTOMER'S RIGHT TO RECOVER DAMAGES CAUSED BY FAULT OR NEGLIGENCE ON THE PART OF NATIONAL INSTRUMENTS SHALL BE LIMITED TO THE AMOUNT THEREFORE PAID BY THE CUSTOMER. NATIONAL INSTRUMENTS WILL NOT BE LIABLE FOR DAMAGES RESULTING FROM LOSS OF DATA, PROFITS, USE OF PRODUCTS, OR INCIDENTAL OR CONSEQUENTIAL DAMAGES, EVEN IF ADVISED OF THE POSSIBILITY THEREOF. This limitation of the liability of National Instruments will apply regardless of the form of action, whether in contract or tort, including negligence. Any action against National Instruments must be brought within one year after the cause of action accrues. National Instruments shall not be liable for any delay in performance due to causes beyond its reasonable control. The warranty provided herein does not cover damages, defects, malfunctions, or service failures caused by owner's failure to follow the National Instruments installation, operation, or maintenance instructions; owner's modification of the product; owner's abuse, misuse, or negligent acts; and power failure or surges, fire, flood, accident, actions of third parties, or other events outside reasonable control.

Copyright

Under the copyright laws, this publication may not be reproduced or transmitted in any form, electronic or mechanical, including photocopying, recording, storing in an information retrieval system, or translating, in whole or in part, without the prior written consent of National Instruments Corporation.

Trademarks

LabVIEW[®], NI-DAQ[®] and RTSI[®] are trademarks of National Instruments Corporation.

Product and company names listed are trademarks or trade names of their respective companies.

Warning Regarding Medical and Clinical Use of National Instruments Products

National Instruments products are not designed with components and testing intended to ensure a level of reliability suitable for use in treatment and diagnosis of humans. Applications of National Instruments products involving medical or clinical treatment can create a potential for accidental injury caused by product failure, or by errors on the part of the user or application designer. Any use or application of National Instruments products for or involving medical or clinical treatment must be performed by properly trained and qualified medical personnel, and all traditional medical safeguards, equipment, and procedures that are appropriate in the particular situation to prevent serious injury or death should always continue to be used when National Instruments products are being used. National Instruments products are NOT intended to be a substitute for any form of established process, procedure, or equipment used to monitor or safeguard human health and safety in medical or clinical treatment.

Contents

About This Manual	vii
Organization of This Manual	vii
Conventions Used in This Manual	viii
The National Instruments Documentation Set	ix
Related Documentation	ix
Customer Communication	x
Chapter 1	
Introduction	1-1
About the SCXI-1163R.....	1-1
What You Need to Get Started	1-1
Software Programming Choices	1-2
LabVIEW and LabWindows Application Software	1-2
NI-DAQ Driver Software.....	1-2
Register-Level Programming	1-4
Optional Equipment	1-4
Custom Cables	1-5
Unpacking	1-6
Chapter 2	
Configuration and Installation	2-1
Module Configuration	2-1
Serial Mode Operation	2-1
Parallel Mode Operation	2-1
Connection to MIO-Type or DIO-Type DAQ Boards	2-2
Jumper Use.....	2-2
Supplementary Jumper W4 Configuration Information	2-5
Hardware Installation	2-6
Chapter 3	
Signal Connections	3-1
Front Connector	3-2
Front Connector Signal Descriptions	3-3
Optically Isolated Solid-State Relay Channels	3-4
Initialization	3-4
Relay Protection for Inductive Load Connections	3-5
Terminal Block	3-5
SCXI-1326 Terminal Block	3-5
SCXI-1326 Installation	3-6
Rear Signal Connector	3-6
Rear Signal Connector Signal Descriptions, Serial Configuration	3-8
Rear Signal Connector Signal Descriptions, Parallel Configuration	3-9

Appendix A	
Specifications	A-1
Appendix B	
Customer Communication	B-1
Glossary	Glossary-1
Index	Index-1

Figures

Figure 1-1.	The Relationship between the Programming Environment, NI-DAQ, and Your Hardware	1-3
Figure 2-1.	SCXI-1163R Parts Locator Diagram	2-3
Figure 2-2.	Removing the SCXI Module Cover	2-4
Figure 3-1.	SCXI-1163R Front Connector Pin Assignment	3-2
Figure 3-2.	Relay Connection Diagram	3-4
Figure 3-3.	Relay Protection When Switching Inductive Loads	3-5
Figure 3-4.	SCXI-1163R Rear Signal Connector Pin Assignment	3-7

Tables

Table 2-1.	Configuration of Jumpers W2, W3, and W5 for DIO-Type and MIO-Type Boards	2-4
Table 2-2.	Configuration of Jumpers W4 and W6	2-5

About This Manual

This manual describes the electrical and mechanical aspects of the SCXI-1163R and contains information concerning its operation and programming. The SCXI-1163R is a member of the National Instruments Signal Conditioning eXtensions for Instrumentation (SCXI) Series modules for the National Instruments DAQ plug-in boards. This module provides 32 isolated solid-state relay outputs configured in banks of four relays. Each bank is isolated from other banks and from the internal circuitry of the SCXI-1163R.

Organization of This Manual

The *SCXI-1163R User Manual* is organized as follows:

- Chapter 1, *Introduction*, describes the SCXI-1163R; lists the contents of your SCXI-1163R kit; describes the optional software, optional equipment, and custom cables; and explains how to unpack the SCXI-1163R kit.
- Chapter 2, *Configuration and Installation*, describes the SCXI-1163R modes of operation, jumper configurations, installation of the SCXI-1163R into the SCXI chassis, signal connections to the SCXI-1163R, and cable wiring.
- Chapter 3, *Signal Connections*, describes the input and output signal connections to the SCXI-1163R module via the SCXI-1163R front connector and rear signal connector. This chapter also includes specifications and connection instructions for the signals on the SCXI-1163R connectors.
- Appendix A, *Specifications*, lists the specifications for the SCXI-1163R.
- Appendix B, *Customer Communication*, contains forms you can use to request help from National Instruments or to comment on our products.
- The *Glossary* contains an alphabetical list and description of terms used in this manual, including abbreviations, acronyms, metric prefixes, mnemonics, and symbols.
- The *Index* contains an alphabetical list of key terms and topics in this manual, including the page where you can find each one.

Conventions Used in This Manual

The following conventions are used in this manual:

<i>bold italic</i>	Bold italic text denotes a note, caution, or warning.
DIO board	DIO board refers to the National Instruments AT-DIO-32F, MC-DIO-24, MC-DIO-32F, NB-DIO-24, NB-DIO-32F, NB-DIO-96, PC-DIO-24, and PC-DIO-96 digital I/O data acquisition boards unless otherwise noted.
DIO-type board	DIO-type board refers to National Instruments data acquisition boards that have only digital inputs and outputs. These boards include the DIO-24, DIO-32F, and DIO-96 boards unless otherwise noted.
<i>italic</i>	Italic text denotes emphasis, a cross reference, or an introduction to a key concept.
Lab board	Lab board refers to the National Instruments Lab-LC, Lab-NB, Lab-PC, and Lab-PC+ boards unless otherwise noted.
MC	MC refers to the Micro Channel series computers.
MIO board	MIO board refers to the National Instruments AT-MIO-16, AT-MIO-16D, AT-MIO-16F-5, AT-MIO-16X, AT-MIO-64F-5, MC-MIO-16, NB-MIO-16, and NB-MIO-16X multichannel I/O data acquisition boards unless otherwise noted.
MIO-type board	MIO-type board refers to National Instruments data acquisition boards that have at least analog and digital inputs and outputs. These boards include the MIO boards, the Lab boards, and the PC-LPM-16 board unless otherwise noted.
monospace	Lowercase text in this font denotes text or characters that are to be literally input from the keyboard, sections of code, programming examples, and syntax examples. This font is also used for the proper names of disk drives, paths, directories, programs, subprograms, subroutines, device names, functions, variables, filenames, and extensions, and for statements and comments taken from program code.
NB	NB refers to the NuBus series computers.
PC	PC refers to the IBM PC/XT, the IBM PC AT, and compatible computers.
SCXIBus	SCXIBus refers to the backplane in the chassis. A signal on the backplane is referred to as the SCXIBus <signal name> line (or signal). The SCXIBus descriptor may be omitted when the meaning is clear. Descriptions of all SCXIBus signals are given in Chapter 3, <i>Signal Connections</i> .
Slot 0	Slot 0 refers to the power supply and control circuitry in the SCXI chassis.

Abbreviations, acronyms, metric prefixes, mnemonics, symbols, and terms are listed in the *Glossary*.

The National Instruments Documentation Set

The *SCXI-1163R User Manual* is one piece of the documentation set for your DAQ or SCXI system. You could have any of several types of manuals, depending on the hardware and software in your system. Use these different types of manuals as follows:

- *Getting Started with SCXI*—If you are using SCXI, this is the first manual you should read. It gives an overview of the SCXI system and contains the most commonly needed information for the modules, chassis, and software.
- Your SCXI hardware user manuals—If you are using SCXI, read these manuals next for detailed information about signal connections and module configuration. They also explain in greater detail how the module works and contain application hints.
- Your DAQ hardware user manuals—These manuals have detailed information about the DAQ hardware that plugs into or is connected to your computer. Use these manuals for hardware installation and configuration instructions, specification information about your DAQ hardware, and application hints.
- Software manuals—Examples of software manuals you may have are the LabVIEW and LabWindows® manual sets and the NI-DAQ manuals. After you have set up your hardware system, use either the application software (LabVIEW or LabWindows) manuals or the NI-DAQ manuals to help you write your application. If you have a large and complicated system, it is worthwhile to look through the software manuals before you configure your hardware.
- Accessory installation guides or manuals—If you are using accessory products, read the terminal block and cable assembly installation guides or accessory board user manuals. They explain how to physically connect the relevant pieces of the system. Consult these guides when you are making your connections.
- SCXI chassis manuals—If you are using SCXI, read these manuals for maintenance information on the chassis and installation instructions.

Related Documentation

The following National Instruments manual contains detailed information for the register-level programmer:

- *SCXI-1163R Register-Level Programmer Manual*

This manual is available from National Instruments by request. If you are using NI-DAQ, LabVIEW, or LabWindows, you should not need the register-level programmer manual. Using NI-DAQ, LabVIEW, or LabWindows is quicker and easier than and as flexible as using the low-level programming described in the register-level programmer manual. Refer to *Software Programming Choices* in Chapter 1, *Introduction*, of this manual to learn about your programming options.

Customer Communication

National Instruments wants to receive your comments on our products and manuals. We are interested in the applications you develop with our products, and we want to help if you have problems with them. To make it easy for you to contact us, this manual contains comment and configuration forms for you to complete. These forms are in Appendix B, *Customer Communication*, at the end of this manual.

Chapter 1

Introduction

This chapter describes the SCXI-1163R; lists the contents of your SCXI-1163R kit; describes the optional software, optional equipment, and custom cables; and explains how to unpack the SCXI-1163R kit.

About the SCXI-1163R

The SCXI-1163R is an SCXI module consisting of 32 optically isolated solid-state relays. The SCXI-1163R module switches loads up to 240 Vrms or VDC and 200 mA where common-mode voltages may be present.

The SCXI-1163R operates in serial mode with full functionality with National Instruments MIO boards; the SCXI-1200 module; the Lab-NB, Lab-PC, Lab-PC+, Lab-LC, and PC-LPM-16 boards; and with the DIO-24, DIO-32F, and DIO-96 boards. You can control several SCXI-1163Rs in serial mode in a single chassis with one DAQ board. In addition, you can control 24 of the relays in parallel mode with a DIO-24, or all 32 relays in parallel mode with a DIO-32F or DIO-96. You can also use the SCXI-1163R in parallel mode with other digital logic sources that meet the specifications in Chapter 3, *Signal Connections*.

An additional shielded terminal block, the SCXI-1326, has screw terminals for easy signal attachment to the SCXI-1163R.

With the SCXI-1163R, you can use the SCXI chassis as a controller in laboratory testing, production testing, and industrial-process monitoring.

What You Need to Get Started

To set up and use your SCXI-1163R, you will need the following components:

- SCXI-1163R module
- *SCXI-1163R User Manual*

If your kit is missing any of the components, contact National Instruments.

Software Programming Choices

There are four options to choose from when programming your National Instruments DAQ and SCXI hardware. You can use LabVIEW, LabWindows, NI-DAQ, or register-level programming software. Your SCXI kit does not include software.

The SCXI-1163R works with LabVIEW for Windows, LabVIEW for Macintosh, LabVIEW for Windows NT, LabWindows for DOS, LabWindows/CVI for Windows, NI-DAQ software for PC compatibles, and NI-DAQ software for Macintosh.

LabVIEW and LabWindows Application Software

LabVIEW and LabWindows are innovative program development software packages for data acquisition and control applications. LabVIEW uses graphical programming, whereas LabWindows enhances traditional programming languages. Both packages include extensive libraries for data acquisition, instrument control, data analysis, and graphical data presentation.

LabVIEW currently runs on three different platforms—AT/MC/EISA computers running Microsoft Windows, the Macintosh platform, and the Sun SPARCstation platform. LabVIEW features interactive graphics, a state-of-the-art user interface, and a powerful graphical programming language. The LabVIEW Data Acquisition VI Library, a series of VIs for using LabVIEW with National Instruments DAQ hardware, is included with LabVIEW. The LabVIEW Data Acquisition VI Libraries are functionally equivalent to the NI-DAQ software, except that the SCXI functions are not included in the LabVIEW software for Sun.

LabWindows has two versions—LabWindows for DOS is for use on PCs running DOS, and LabWindows/CVI is for use on PCs running Windows and for Sun SPARCstations. LabWindows/CVI features interactive graphics, a state-of-the-art user interface, and uses the ANSI standard C programming language. The LabWindows Data Acquisition Library, a series of functions for using LabWindows with National Instruments DAQ hardware, is included with the NI-DAQ software kit. The LabWindows Data Acquisition libraries are functionally equivalent to the NI-DAQ software, except that the SCXI functions are not included in the LabWindows/CVI software for Sun.

Using LabVIEW or LabWindows software will greatly reduce the development time for your data acquisition and control application.

NI-DAQ Driver Software

The NI-DAQ driver software is included at no charge with all National Instruments DAQ hardware. NI-DAQ is not packaged with SCXI or accessory products. NI-DAQ has an extensive library of functions that you can call from your application programming environment. These functions include routines for analog input (A/D conversion), buffered data acquisition (high-speed A/D conversion), analog output (D/A conversion), waveform generation, digital I/O, counter/timer operations, SCXI, RTSI, self-calibration, messaging, and acquiring data to extended memory.

NI-DAQ also internally addresses many of the complex issues between the computer and the DAQ hardware such as programming interrupts and DMA controllers. NI-DAQ maintains a consistent software interface among its different versions so that you can change platforms with minimal modifications to your code. Figure 1-1 illustrates the relationship between NI-DAQ and LabVIEW and LabWindows. You can see that the data acquisition parts of LabVIEW and LabWindows are functionally equivalent to the NI-DAQ software.

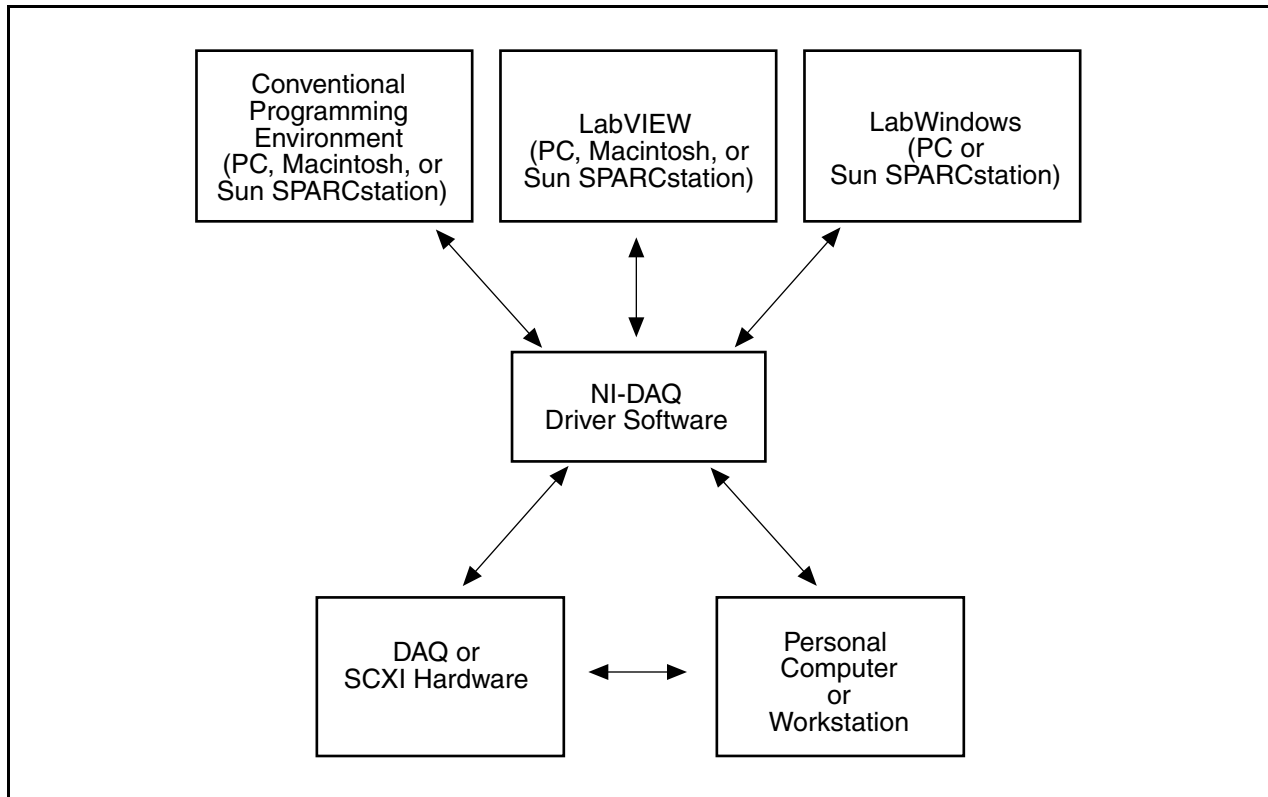

Figure 1-1. The Relationship between the Programming Environment, NI-DAQ, and Your Hardware

The National Instruments PC, AT, MC, DAQCard, and DAQPad Series DAQ hardware are packaged with NI-DAQ software for PC compatibles. NI-DAQ software for PC compatibles comes with language interfaces for Professional BASIC, Turbo Pascal, Turbo C, Turbo C++, Borland C++, and Microsoft C for DOS; and Visual Basic, Turbo Pascal, Microsoft C with SDK, and Borland C++ for Windows. You can use your SCXI-1163R, together with other PC, AT, MC, DAQCard, and SCXI hardware, with NI-DAQ software for PC compatibles.

The National Instruments NB Series DAQ boards are packaged with NI-DAQ software for Macintosh. NI-DAQ software for Macintosh comes with language interfaces for MPW C, THINK C, Pascal, and Microsoft QuickBASIC. Any language that uses Device Manager Toolbox calls can access NI-DAQ software for Macintosh. You can use NB Series DAQ boards and SCXI hardware with NI-DAQ software for Macintosh.

The National Instruments SB Series DAQ boards are packaged with NI-DAQ software for Sun, which comes with a language interface for ANSI C.

Register-Level Programming

The final option for programming any National Instruments DAQ hardware is to write register-level software. Writing register-level programming software can be very time-consuming and inefficient, and is not recommended for most users. The *only* users who should consider writing register-level software should meet at least one of the following criteria:

- National Instruments does not support your operating system or programming language.
- You are an experienced register-level programmer who is more comfortable writing your own register-level software.

Even if you are an experienced register-level programmer, consider using NI-DAQ, LabVIEW, or LabWindows to program your National Instruments DAQ hardware. Using the NI-DAQ, LabVIEW, or LabWindows software is easier than, and as flexible as, register-level programming, and can save weeks of development time.

The *SCXI-1163R User Manual* and your software manuals contain complete instructions for programming your SCXI-1163R with NI-DAQ, LabVIEW, or LabWindows. If you are using NI-DAQ, LabVIEW, or LabWindows to control your hardware, you should not need the register-level programmer manual.

The *SCXI-1163R Register-Level Programmer Manual* contains low-level programming details, such as register maps, bit descriptions, and register programming hints, that you will need only for register-level programming. If you want to obtain the register-level programmer manual, please fill out the *Register-Level Programmer Manual Request Form* in Appendix B, *Customer Communication*, at the end of this manual and send it to National Instruments.

Optional Equipment

Contact National Instruments for ordering information for any of the following optional equipment:

- SCXI-1326 front terminal block
- SCXI-1340 cable assembly
- SCXI-1341 Lab-NB/Lab-PC/Lab-PC+ cable assembly
- SCXI-1342 PC-LPM-16 cable assembly
- SCXI-1343 rear screw terminal adapter
- SCXI-1344 Lab-LC cable assembly
- SCXI-1348 DIO-32F cable assembly
- SCXI-1350 multichassis adapter
- SCXI-1351 one-slot cable extender

The standard ribbon and NB5 cables are available in the following lengths:

- 0.5 m
- 1.0 m

Refer to Chapter 3, *Signal Connections*, and to your cable installation guide for additional information on cabling, connectors, and adapters.

Custom Cables

The SCXI-1163R rear signal connector is a 50-pin male ribbon-cable header. The manufacturer part number of the header National Instruments uses is as follows:

- AMP Inc. (part number 1-103310-0)

The mating connector for the SCXI-1163R rear signal connector is a 50-position polarized ribbon-socket connector with strain relief. National Instruments uses a polarized or keyed connector to prevent inadvertent upside-down connection to the SCXI-1163R. The recommended manufacturer part numbers for this mating connector are as follows:

- Electronic Products Division/3M (part number 3425-7650)
- T&B/Ansley Corporation (part number 609-5041CE)

Standard 50-conductor 28 AWG stranded ribbon cables that work with these connectors are as follows:

- Electronic Products Division/3M (part number 3365/50)
- T&B/Ansley Corporation (part number 171-50)

The SCXI-1163R front connector is a special 48-pin DIN C male connector. The manufacturer part number of the connector National Instruments uses is as follows:

- ERNI Components, Inc. (part number 033-273)

The mating connector for the SCXI-1163R front connector is a special 48-pin reversed DIN C female connector. National Instruments uses a polarized and keyed connector to prevent inadvertent upside-down connection to the SCXI-1163R. The manufacturer part number of the connector National Instruments uses is as follows:

- ERNI Components, Inc. (part number 913-495)

National Instruments selected these connectors to meet UL 1244 for 450 Vrms working isolation.

Unpacking

Your SCXI-1163R module is shipped in an antistatic package to prevent electrostatic damage to the module. Electrostatic discharge can damage several components on the module. To avoid such damage in handling the module, take the following precautions:

- Ground yourself via a grounding strap or by holding a grounded chassis such as an SCXI chassis.
- Touch the antistatic package to a metal part of your SCXI chassis before removing the module from the package.
- Remove the module from the package and inspect the module for loose components or any other sign of damage. Notify National Instruments if the module appears damaged in any way. *Do not* install a damaged module into your SCXI chassis.
- *Never* touch the exposed pins of connectors.

Chapter 2

Configuration and Installation

This chapter describes the SCXI-1163R modes of operation, jumper configurations, installation of the SCXI-1163R into the SCXI chassis, signal connections to the SCXI-1163R, and cable wiring.

Module Configuration

You can configure the SCXI-1163R for operation in either serial or parallel mode and connect the module to either an MIO-type board or a DIO-type board.

Note: *The SCXI-1163R is factory-configured for serial communication through a DIO-type board or through the SCXI chassis. You should change the jumper configuration from the factory-default settings ONLY if you plan to cable the SCXI-1163R rear connector to an MIO-type board, if you plan to use the SCXI-1163R in parallel mode, or if the SCXI-1163R is a controller module for a multichassis system.*

Serial Mode Operation

When you configure the SCXI-1163R for serial mode operation, serial commands sent to the module via the SCXIbus control the relay states. If you connect a DAQ board to the rear signal connector of an SCXI-1163R in serial mode, then data from that board will control the SCXIbus. You can connect only one serial mode SCXI-1163R per chassis to a DAQ board. You must not cable the rear signal connectors of other SCXI-1163Rs configured for serial mode to anything.

If you configure the SCXI-1163R for serial mode, the module *cannot* accept parallel data. The serial mode of operation cannot be overridden by software.

When data is sent to the SCXI-1163R, a logic high (or 1) will open a relay, preventing current from flowing, and a logic low (or 0) will close the relay, allowing current to flow. Your National Instruments software manual has more information on the commands used to control the SCXI-1163R and the SCXI chassis. If you are not using National Instruments software, see the *SCXI-1163R Register-Level Programmer Manual* for a description of the procedures for serial communication with the SCXI-1163R.

Parallel Mode Operation

When you configure the SCXI-1163R for parallel mode operation, signals at the rear signal connector directly control the states of the solid-state relays; no serial commands to the module are needed. A logic low (or 0) on the rear connector will close the corresponding relay, allowing current to flow. Likewise, a logic high (or 1) will open the relay, preventing the flow of current. In parallel mode, the signals on the rear signal connector *cannot* communicate with the SCXI chassis or with any other module in the chassis. Hence, if multiple SCXI-1163Rs in an SCXI system are to be used in parallel mode, the rear signal connector of each must be connected to a separate DAQ board or other controlling source.

However, even if you configure an SCXI-1163R for parallel mode operation, you can still control it serially through the SCXI system. For example, if you configure one SCXI-1163R in a chassis for parallel mode and you configure another SCXI-1163R cabled to a DAQ board for serial mode, the DAQ board can control *both* SCXI-1163Rs by overriding the parallel mode of the first SCXI-1163R and sending data to it serially. The first SCXI-1163R will no longer respond to signals on its rear signal connector until it is reset, either by software through the DAQ board, or by the reset button on the SCXI chassis.

If you configure your National Instruments software to communicate with an SCXI-1163R in serial mode (through the `WDAQCONF` or `DAQCONF` utilities), but have the SCXI-1163R jumpers configured for parallel mode, then the software will attempt to perform serial writes to the SCXI-1163R, overriding the parallel mode of communication.

If you are not using National Instruments software, see the *SCXI-1163R Register-Level Programmer Manual* for information on serial communication and overriding the parallel mode of operation.

Connection to MIO-Type or DIO-Type DAQ Boards

When you cable the SCXI-1163R to a DAQ board, you must also configure the SCXI-1163R to recognize the board either as a DIO-type or an MIO-type board. DIO-type boards are National Instruments boards that have only digital inputs and outputs. These boards include the DIO-24, DIO-32F, and DIO-96. MIO-type boards are National Instruments boards that have both analog and digital inputs and digital outputs. These boards consist of MIO boards; Lab-NB, Lab-PC, Lab-PC+, and Lab-LC boards; and PC-LPM-16 boards. You can use either type for serial communication; for parallel communication, you can use only the DIO-type boards. However, when you use the DIO-24 for *parallel* communication, only channels 0 through 23 can be controlled on the SCXI-1163R.

Jumper Use

To configure the SCXI-1163R module, use the five user-configurable jumpers shown in the parts locator diagram, Figure 2-1. There is also one reserved jumper that should remain empty. Tables 2-1 and 2-2 list the description and configuration of the user-configurable jumpers. To change the configuration of the module, refer to Figure 2-1 and 2-2 as you perform the following steps:

1. Remove the grounding screw of the top cover.
2. Snap out the top cover of the shield by placing a screwdriver in the groove at the bottom of the module.
3. Remove the jumpers to be changed and replace them on the appropriate pins.
4. Record the new jumper settings on the *SCXI-1163R Hardware Configuration Form* in Appendix B, *Customer Communication*.
5. Snap the top cover back in place.
6. Replace the grounding screw to ensure proper shielding.

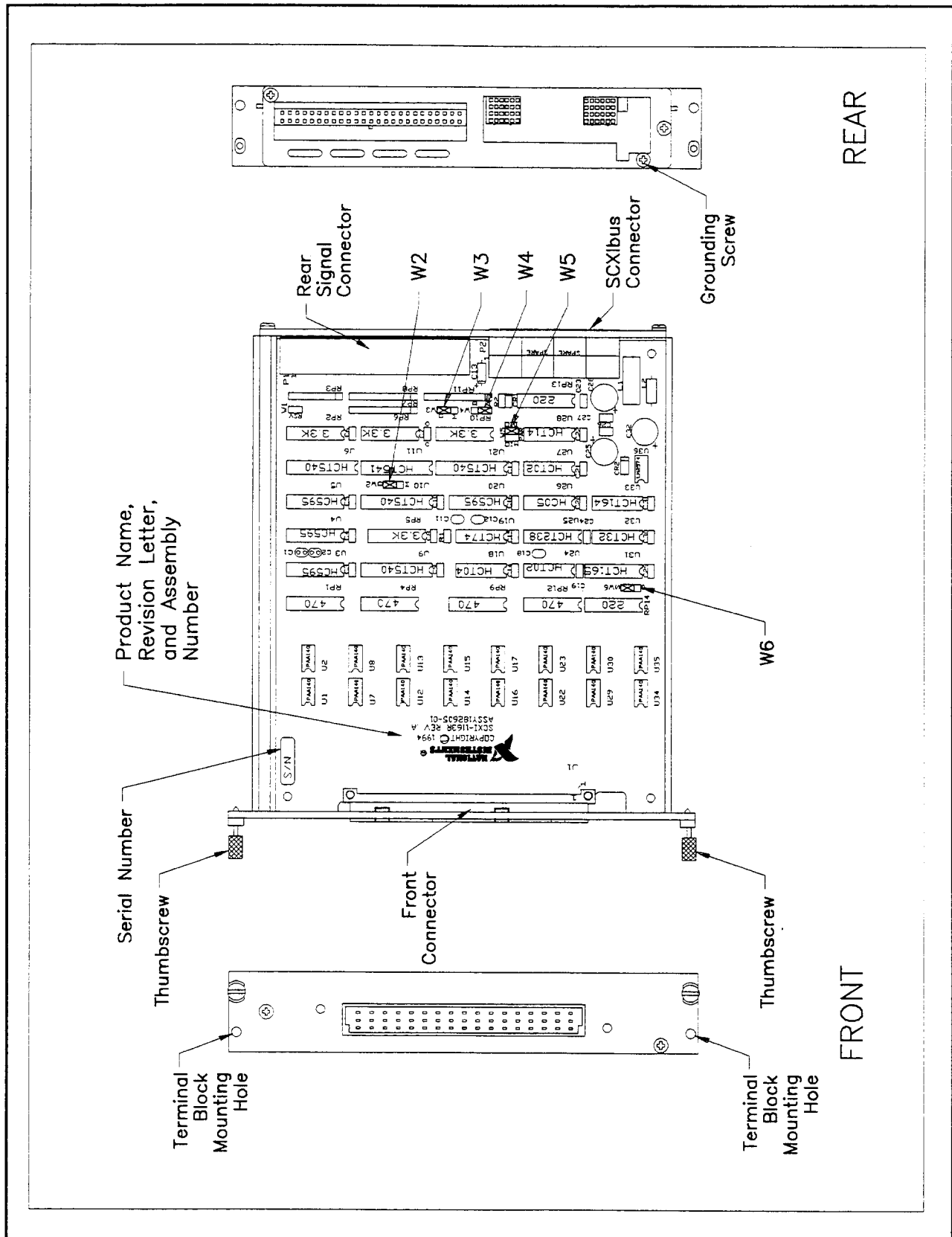

Figure 2-1. SCXI-1163R Parts Locator Diagram

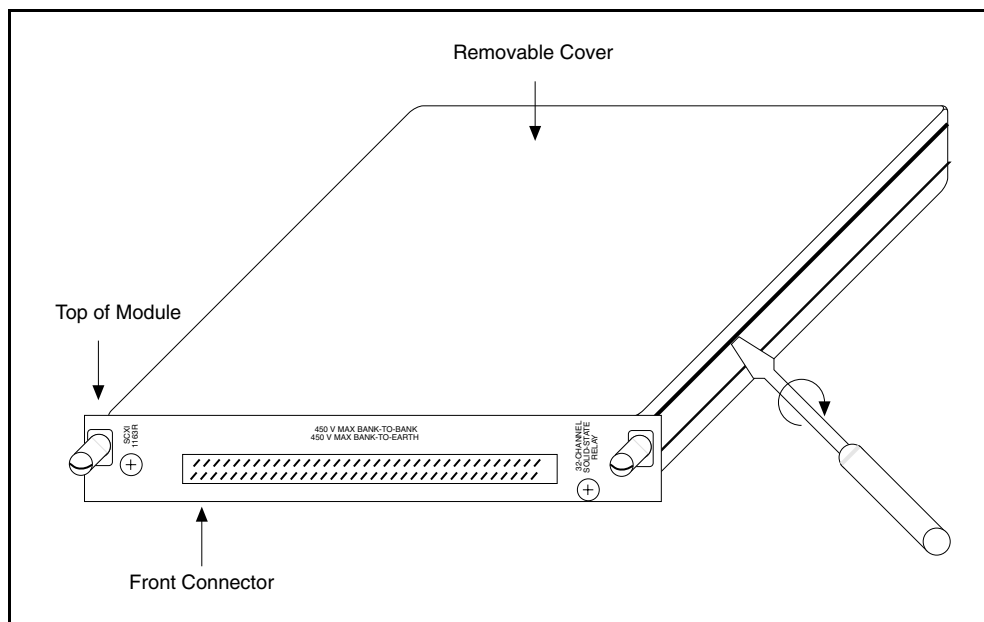
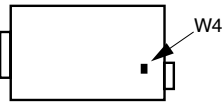

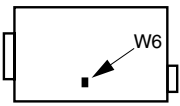
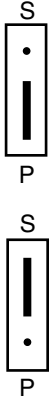

Figure 2-2. Removing the SCXI Module Cover

Table 2-1. Configuration of Jumpers W2, W3, and W5 for DIO-Type and MIO-Type Boards

Jumper	Description	Configuration for DIO-Type Board	Configuration for MIO-Type Board
	Configures rear connector— Factory setting is for DIO-type boards.		
	Configures rear connector— Factory setting is for DIO-type boards.		
	Configures SERDATOUT for a DIO-type or MIO-type board— Factory setting is for DIO-type boards. Parking position—Disconnects SERDATOUT. Use this setting for parallel mode.		

Table 2-2. Configuration of Jumpers W4 and W6

Jumper	Description	Configuration
	<p>Position A—Use this setting for a single-chassis system. (Factory setting)</p> <p>Position B—Use this setting for an additional chassis in a multichassis system.</p>	
	<p>Sets primary mode of operation to parallel.</p> <p>Factory setting—Sets primary mode of operation to serial.</p>	

Note: *The shaded portion indicates the position of the jumper.*

Supplementary Jumper W4 Configuration Information

Jumper W4, when set to position A, connects a 2.2 k Ω pull-up resistor to the SERDATOUT line. An open-collector driver drives the SERDATOUT line. An open-collector driver actively drives low or goes to a high-impedance state, relying on a pull-up resistor to make the signal line go high. If too many pull-up resistors are attached to the SERDATOUT line, the drivers cannot drive the line low. To prevent this, set jumper W4 to position A on only one of the SCXI-1163Rs that are cabled to the DAQ board in a multichassis system. It does not matter which of the SCXI-1163Rs cabled to the DAQ board has the pull-up connected.

Hardware Installation

You can install the SCXI-1163R in any available SCXI chassis. After you have made any necessary changes and have verified and recorded the jumper settings on the form in Appendix B, *Customer Communication*, you are ready to install the SCXI-1163R. The following are general installation instructions; consult the user manual or technical reference manual of your SCXI chassis for specific instructions and warnings.

1. Turn off the computer that contains the DAQ board or disconnect the computer from your SCXI chassis.
2. Turn off the SCXI chassis. Do not insert the SCXI-1163R into a chassis that is turned on.
3. Insert the SCXI-1163R into the board guides. Gently guide the module into the back of the slot until the connectors make good contact. If you have already installed a cable assembly in the rear of the chassis, you must firmly engage the module and cable assembly; however, do not *force* the module into place.
4. Screw the front mounting panel of the SCXI-1163R to the top and bottom threaded strips of your SCXI chassis.
5. If this module is to be connected to an MIO-16 or to a DIO-24 DAQ board, attach the connector at the metal end of the SCXI-1340 cable assembly to the rear signal connector on the SCXI-1163R module. Screw the rear panel to the rear threaded strip. Attach the loose end of the cable to the MIO-16 or DIO-24 board.

Note: *For installation procedures with other SCXI accessories and DAQ boards, consult your cable installation guide.*

6. Check the installation.
7. Turn on the SCXI chassis.
8. Turn on the computer or reconnect the computer to your chassis.

The SCXI-1163R board is installed. You are now ready to install and configure your software.

Chapter 3

Signal Connections

This chapter describes the input and output signal connections to the SCXI-1163R module via the SCXI-1163R front connector and rear signal connector. This chapter also includes specifications and connection instructions for the signals on the SCXI-1163R connectors.

Warning: *Connections that exceed any of the maximum ratings of input signals on the SCXI-1163R can damage the SCXI-1163R board and the SCXIbus. Maximum input ratings for each signal are given in this chapter under the discussion of that signal. National Instruments is not liable for any damages resulting from signal connections that exceed these ratings.*

KEEP AWAY FROM LIVE CIRCUITS. Do not remove equipment covers or shields unless you are trained to do so. If signal wires are connected to the module or terminal block, dangerous voltages may exist even when the equipment is turned off. To avoid dangerous electrical shock, do not perform procedures involving cover or shield removal unless you are qualified to do so.

DO NOT OPERATE DAMAGED EQUIPMENT. The safety protection features built into this module can become impaired if the module becomes damaged in any way. If it is damaged, turn the module off and do not use until service-trained personnel can check its safety. If necessary, return the module to National Instruments for service and repair to ensure that its safety is not compromised.

DO NOT SUBSTITUTE PARTS OR MODIFY EQUIPMENT. Because of the danger of introducing additional hazards, do not install unauthorized parts or modify the module. Return the module to National Instruments for service and repair to ensure that its safety features are not compromised.

When using the terminal block with high common-mode voltages, you MUST insulate your signal wires appropriately. National Instruments is NOT liable for any damages or injuries resulting from inadequate signal wire insulation.

When connecting or disconnecting signal lines to the SCXI-1326 terminal block screw terminals, make sure the lines are powered off to prevent shock hazard.

Connections, including power signals to ground and vice versa, that exceed any of the maximum signal ratings on the SCXI-1163R can damage any or all of the boards connected to the SCXI chassis, the host computer, and the SCXI-1163R module. National Instruments is NOT LIABLE FOR ANY DAMAGES OR INJURIES resulting from incorrect signal connections.

If high voltages (≥ 42 Vrms or 60 VDC) are present, YOU MUST CONNECT THE SAFETY EARTH GROUND TO THE STRAIN-RELIEF TAB. This complies with UL 1244 and protects against electric shock when the terminal block is not connected to the chassis. To connect the safety earth ground to the strain-relief tab, run an earth ground wire in the cable from the signal source to the terminal block. National Instruments is NOT liable for any damages or injuries resulting from inadequate safety earth ground connections.

Front Connector

Figure 3-1 shows the pin assignments for the SCXI-1163R front connector.

Pin Number	Signal Name	Column			Signal Name
		A	B	C	
30	CHAN(0)				NC
	CHAN(1)				
	CHAN(2)				
29	CHAN(3)				GND
	CHAN(4)				
	CHAN(5)				
26	CHAN(6)				NC
	CHAN(7)				
	CHAN(8)				
25	CHAN(9)				GND
	CHAN(10)				
	CHAN(11)				
22	CHAN(12)				NC
	CHAN(13)				
	CHAN(14)				
21	CHAN(15)				GND
	CHAN(16)				
	CHAN(17)				
18	CHAN(18)				NC
	CHAN(19)				
	CHAN(20)				
17	CHAN(21)				GND
	CHAN(22)				
	CHAN(23)				
14	CHAN(24)				GND
	CHAN(25)				
	CHAN(26)				
13	CHAN(27)				NC
	CHAN(28)				
	CHAN(29)				
10	CHAN(30)				GND
	CHAN(31)				
	CHAN(32)				
9	CHAN(33)				NC
	CHAN(34)				
	CHAN(35)				
6	CHAN(36)				GND
	CHAN(37)				
	CHAN(38)				
5	CHAN(39)				NC
	CHAN(40)				
	CHAN(41)				
2	CHAN(42)				GND
	CHAN(43)				
	CHAN(44)				
1	CHAN(45)				NC
	CHAN(46)				
	CHAN(47)				

Figure 3-1. SCXI-1163R Front Connector Pin Assignment

Front Connector Signal Descriptions

Pin	Signal Name	Description
B30, A30, B29, A29	CHAN<0..3>	Bank 0 channels
C30	NC	No connect
C29	GND	Bank 0 common
B26, A26, B25, A25	CHAN<4..7>	Bank 1 channels
C26	NC	No connect
C25	GND	Bank 1 common
B22, A22, B21, A21	CHAN<8..11>	Bank 2 channels
C22	NC	No connect
C21	GND	Bank 2 common
B18, A18, B17, A17	CHAN<12..15>	Bank 3 channels
C18	NC	No connect
C17	GND	Bank 3 common
A13, B13, A14, B14	CHAN<16..19>	Bank 4 channels
C14	GND	Bank 4 common
C13	NC	No connect
A9, B9, A10, B10	CHAN<20..23>	Bank 5 channels
C10	GND	Bank 5 common
C9	NC	No connect
A5, B5, A6, B6	CHAN<24..27>	Bank 6 channels
C6	GND	Bank 6 common
C5	NC	No connect
A1, B1, A2, B2	CHAN<28..31>	Bank 7 channels
C2	GND	Bank 7 common
C1	NC	No connect

Optically Isolated Solid-State Relay Channels

The SCXI-1163R relays are solid-state relays. These relays have no moving parts and hence are not subject to the limited lifetimes of electromechanical relays. In the closed state, each of these relays has a maximum on resistance of $8\ \Omega$, and carries up to 200 mA of current. In the open state, each relay blocks up to 240 V (DC or AC) with a maximum leakage current of $1\ \mu\text{A}$. To prevent damage to these relays, do not attempt to switch loads of greater than 240 V or 200 mA.

Each of the 32 relays is an independently controlled Form A (normally open) relay. The relays are grouped in eight banks of four solid-state relays. Figure 3-2 shows that each group of four relays shares one common pole. The signal name for these common poles is GND, but they do not need to be connected to ground. Each GND signal is simply the common pole of a bank of four relays. Each of the eight banks is optically isolated to 450 Vrms from each other and from the SCXI chassis earth ground. However, there is no isolation barrier between signals of the same bank.

When you operate the relays in serial mode, a single command to change the relay states causes all of the relays to change states at the same time at the end of the command. In parallel mode, each relay independently changes as its controlling signal on the rear signal connector changes. The relays take a maximum of 1.5 ms to turn on, and 0.25 ms to turn off.

Initialization

When you power up the SCXI chassis or press the chassis reset button, the relays are initially in the open state if you have configured the module for serial mode operation. If you have configured the module for parallel mode operation, the relays power up in the states determined by the signals on the rear signal connector. If nothing is connected to the rear connector, the relays will be in the open state.

All relays return to the open state if you remove power from the module.

Note: *It is important to notice that this module has no access to the analog backplane; this protects the backplane from faults when high voltages are available at the module outputs.*

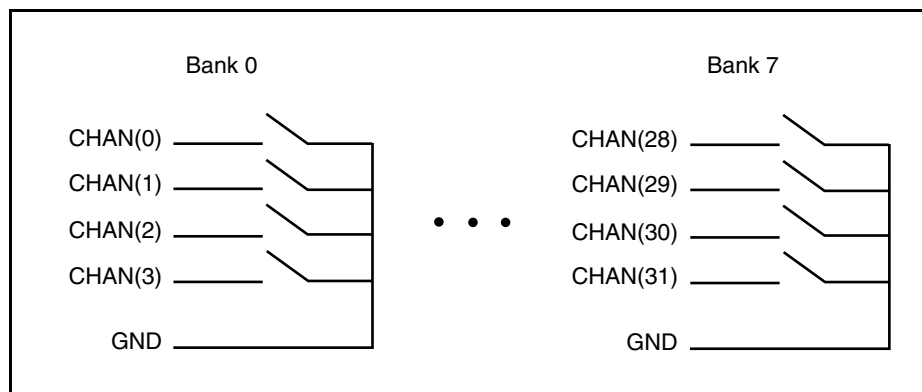

Figure 3-2. Relay Connection Diagram

Relay Protection for Inductive Load Connections

When inductive loads are connected to the solid-state relays, a large counter-electromotive force can occur at relay switching time because of the energy stored in the inductive load. These flyback voltages can severely damage the relays.

It is best to limit these flyback voltages at your inductive load by installing, across your inductive load, a flyback diode for DC loads (see Figure 3-3) or an MOV (metal oxide varistor) for AC loads.

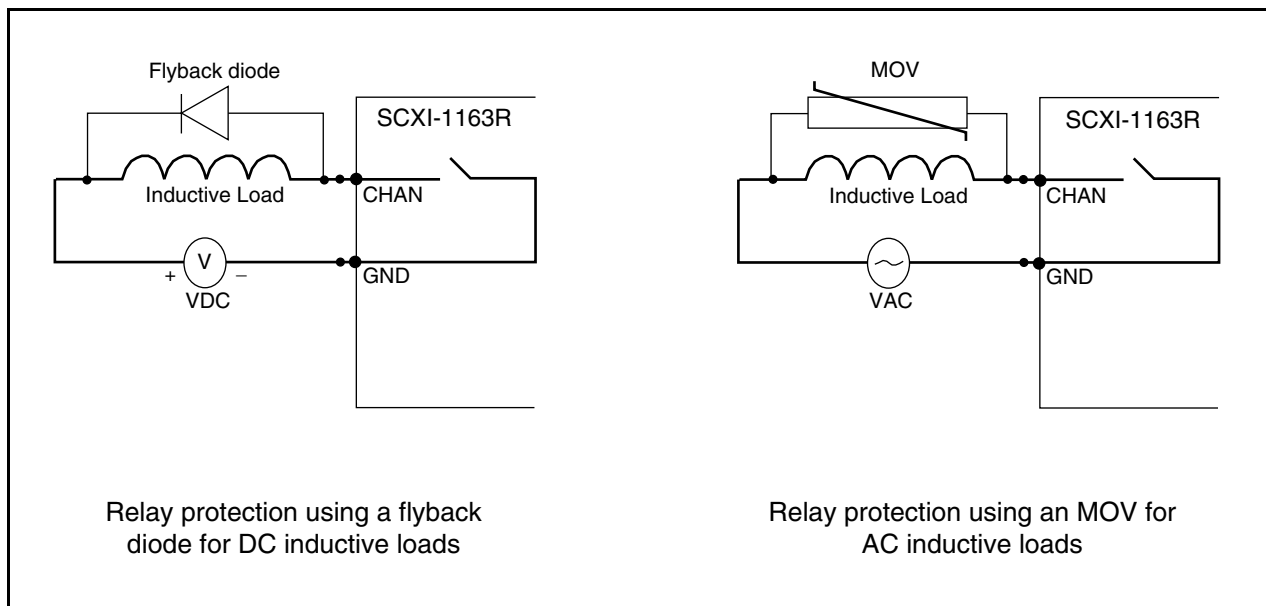

Figure 3-3. Relay Protection When Switching Inductive Loads

Terminal Block

To connect the signals to the SCXI-1163R outputs, you can use a National Instruments terminal block with screw terminals for easy connection. Refer to your terminal block installation guide for instructions on connecting your SCXI-1163R.

The terminal block kit is listed in the *Optional Equipment* section in Chapter 1, *Introduction*.

SCXI-1326 Terminal Block

The SCXI-1326 front terminal block consists of a shielded board with supports to connect it to the SCXI-1163R front connector. There are forty-eight screw terminals. The terminals labeled "VCC" on the SCXI-1326 are not used with the SCXI-1163R.

SCXI-1326 Installation

To connect the terminal block to the SCXI-1163R front connector, follow these steps:

1. Connect the SCXI-1163R front connector to its mating connector on the terminal block.
2. Make sure that the SCXI-1163R top and bottom thumbscrews do not obstruct the rear panel of the terminal block.
3. Tighten the top and bottom screws on the back of the terminal block to hold the terminal block securely in place.

Rear Signal Connector

Note: *If you are using the SCXI-1163R with a National Instruments DAQ board and cable assembly, you do not need to read the remainder of this chapter. If you are using the SCXI-1180 feedthrough panel or the SCXI-1343 rear screw terminal adapter with the SCXI-1163R, read this section.*

The rear signal connector is configured based on the jumper settings described earlier in this chapter. Jumper W6 determines whether the rear connector will be used for serial or parallel communication. If you set jumper W6 to serial, jumpers W2, W3, and W5 determine whether the rear connector is configured for an MIO-type connection or a DIO-type connection.

Figure 3-4A shows the pin assignments for the SCXI-1163R rear signal connector configured for serial communication. Figure 3-4B shows the pin assignments for the rear signal connector configured for parallel communication.

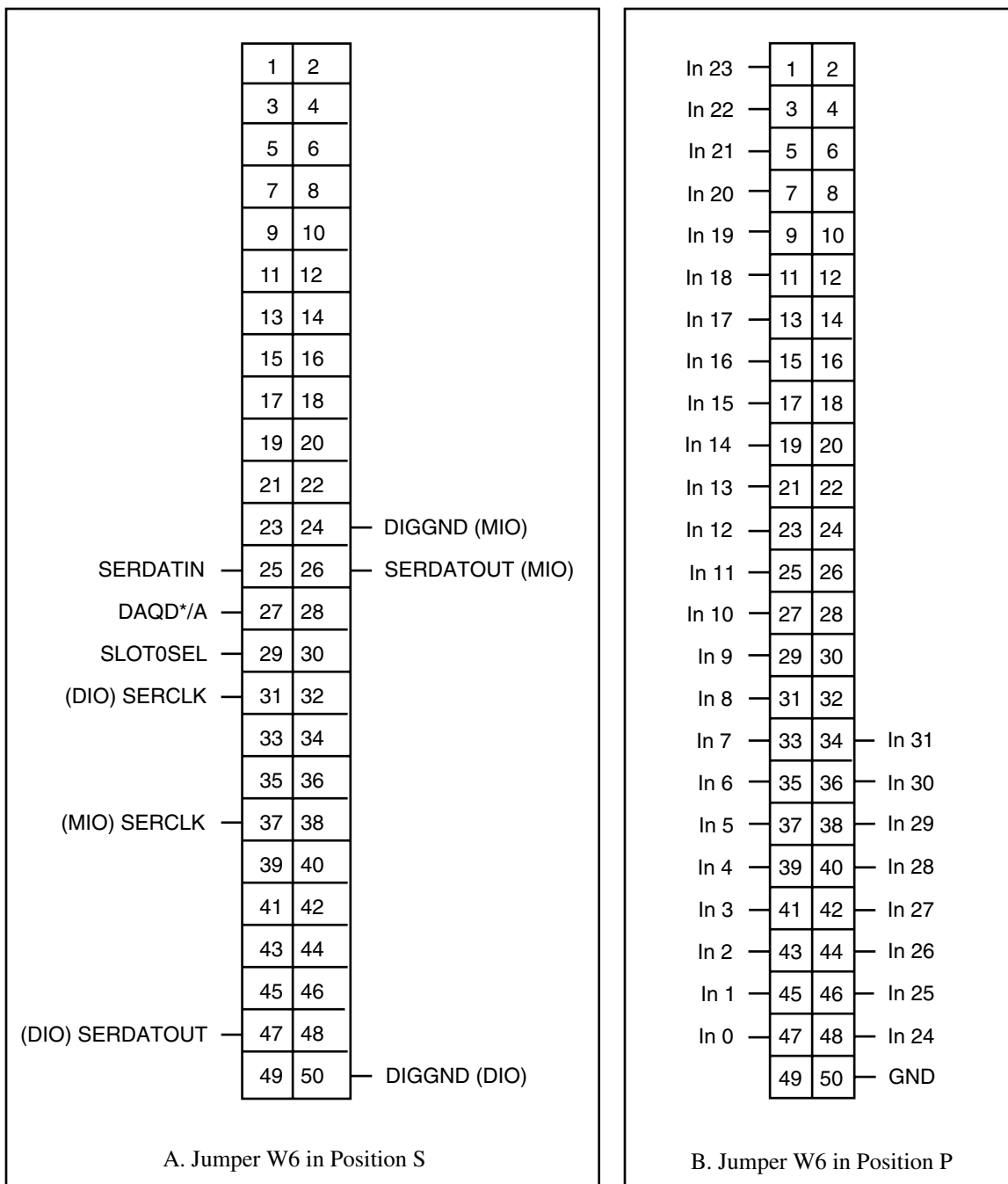

Figure 3-4. SCXI-1163R Rear Signal Connector Pin Assignment

Rear Signal Connector Signal Descriptions, Serial Configuration

Pin	Signal Name	Description
24, 50	DIGGND	Digital Ground—Supplies the reference for DAQ board digital signals and is tied to the module digital ground. Pin 50 is for DIO-type boards. Pin 24 is for MIO-type boards. Jumper W3 selects the pin. Pins 24 and 50 are <i>not</i> tied together.
25	SERDATIN	Serial Data In—Taps into the SCXIBus MOSI line to provide serial input data to a module or Slot 0.
26, 47	SERDATOUT	Serial Data Out—Taps into the SCXIBus MISO line to accept serial output data from a module. Pin 47 is for DIO-type boards. Pin 26 is for MIO-type boards. Jumper W5 selects the pin. Pins 26 and 47 are <i>not</i> tied together.
27	DAQD*/A	DAQ Board Data/Address Line—Taps into the SCXIBus D*/A line to indicate to the module whether the incoming serial stream is data or address information.
29	SLOT0SEL*	Slot 0 Select—Taps into the SCXIBus INTR* line to indicate whether the information on MOSI is sent to a module or to Slot 0.
31, 37	SERCLK	Serial Clock—Taps into the SCXIBus SPICLK line to clock the data on the MOSI and MISO lines. Pin 31 is for DIO-type boards. Pin 37 is for MIO-type boards. Jumper W2 selects the pin. Pins 31 and 37 are <i>not</i> tied together.

* Indicates active low.

All other pins are not connected.

See Chapter 5, *Timing*, of the *SCXI-1163R Register-Level Programmer Manual* for more detailed information on serial communication and programming.

Appendix A

Specifications

This appendix lists the specifications for the SCXI-1163R. These specifications are typical at 25° C unless otherwise noted.

Solid-State Relays

Number of channels	32, organized as eight optically isolated banks of four independently controlled Form A relays with one common pole per bank
Load voltage (DC or rms AC)	240 V max
Load current	200 mA max
On resistance	8 Ω max
Output capacitance	110 pF at 50 V, 1 MHz
Leakage current	1 μ A max
Isolation	Bank to bank and bank to ground
Working voltage	450 Vrms max
Maximum speed	
Turn-on time	1.5 ms
Turn-off time	0.25 ms
Serial data rate	
Measured using NI-DAQ software on a 486-50 computer	1000 writes/s
Power-on state	relays open

Physical

Dimensions	1.2 by 6.8 by 8.0 in. (3.0 by 17.3 by 20.3 cm)
I/O Connectors	50-pin male ribbon-cable rear connector 48-pin DIN C male front connector (48-screw terminal adapter available)

Environment

Operating temperature	0° to 50° C
Storage temperature	-40° to 125° C
Relative humidity	5% to 90% noncondensing

Appendix B

Customer Communication

For your convenience, this appendix contains forms to help you gather the information necessary to help us solve technical problems you might have as well as a form you can use to comment on the product documentation. Filling out a copy of the *Technical Support Form* before contacting National Instruments helps us help you better and faster.

National Instruments provides comprehensive technical assistance around the world. In the U.S. and Canada, applications engineers are available Monday through Friday from 8:00 a.m. to 6:00 p.m. (central time). In other countries, contact the nearest branch office. You may fax questions to us at any time.

Corporate Headquarters

(512) 795-8248

Technical support fax: (800) 328-2203
(512) 794-5678

Branch Offices	Phone Number	Fax Number
Australia	(03) 879 9422	(03) 879 9179
Austria	(0662) 435986	(0662) 437010-19
Belgium	02/757.00.20	02/757.03.11
Denmark	45 76 26 00	45 76 71 11
Finland	(90) 527 2321	(90) 502 2930
France	(1) 48 14 24 00	(1) 48 14 24 14
Germany	089/741 31 30	089/714 60 35
Italy	02/48301892	02/48301915
Japan	(03) 3788-1921	(03) 3788-1923
Netherlands	03480-33466	03480-30673
Norway	32-848400	32-848600
Spain	(91) 640 0085	(91) 640 0533
Sweden	08-730 49 70	08-730 43 70
Switzerland	056/20 51 51	056/20 51 55
U.K.	0635 523545	0635 523154

Technical Support Form

Photocopy this form and update it each time you make changes to your software or hardware, and use the completed copy of this form as a reference for your current configuration. Completing this form accurately before contacting National Instruments for technical support helps our applications engineers answer your questions more efficiently.

If you are using any National Instruments hardware or software products related to this problem, include the configuration forms from their user manuals. Include additional pages if necessary.

Name _____

Company _____

Address _____

Fax (___) _____ Phone (___) _____

Computer brand _____ Model _____ Processor _____

Operating system _____

Speed _____ MHz RAM _____ MB Display adapter _____

Mouse _____ yes _____ no Other adapters installed _____

Hard disk capacity _____ MB Brand _____

Instruments used _____

National Instruments hardware product model _____ Revision _____

Configuration _____

National Instruments software product _____ Version _____

Configuration _____

The problem is _____







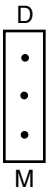

List any error messages _____

The following steps will reproduce the problem _____

SCXI-1163R Hardware Configuration Form

Record the settings and revisions of your hardware and software on the line to the right of each item. Complete a new copy of this form each time you revise your software or hardware configuration, and use this form as a reference for your current configuration. Completing this form accurately before contacting National Instruments for technical support helps our applications engineers answer your questions more efficiently.

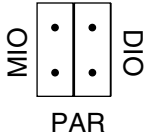
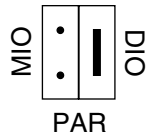
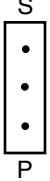
- SCXI-1163R Revision _____
- Chassis Slot _____
- Chassis Type _____

	My Setting	Factory Setting
• Jumper W2		
• Jumper W3		
• Jumper W4		
• Jumper W5		
• Jumper W6		

Note: Mark your jumper positions on the jumper diagrams in the left column.

- Other Modules and Chassis in System _____
- DAQ Boards Installed _____

Register-Level Programmer Manual Request Form

National Instruments encourages you to comment on the documentation supplied with our products. This information helps us provide quality products to meet your needs.

Title: **SCXI-1163R Register-Level Programmer Manual**

Part Number: **320677A-01**

Please indicate your reasons for obtaining the register-level programmer manual. Check all that apply.

- National Instruments does not support your operating system or programming language.
- You are an experienced register-level programmer who is more comfortable writing your own register-level software.
- Other. Please explain.

Thank you for your help.

Name _____

Title _____

Company _____

Shipping Address _____

(Street Address, Not P.O. Box) _____

Phone (_____) _____

Mail to: Data Entry Department
National Instruments Corporation
6504 Bridge Point Parkway
Austin, TX 78730-5039

Fax to: Data Entry Department
National Instruments Corporation
(512) 794-8411

Documentation Comment Form

National Instruments encourages you to comment on the documentation supplied with our products. This information helps us provide quality products to meet your needs.

Title: **SCXI-1163R User Manual**

Edition Date: **July 1994**

Part Number: **320677A-01**

Please comment on the completeness, clarity, and organization of the manual.

If you find errors in the manual, please record the page numbers and describe the errors.

Thank you for your help.

Name _____

Title _____

Company _____

Address _____

Phone (_____) _____

Mail to: Technical Publications
National Instruments Corporation
6504 Bridge Point Parkway, MS 53-02
Austin, TX 78730-5039

Fax to: Technical Publications
National Instruments Corporation
MS 53-02
(512) 794-5678

Glossary

Prefix	Meaning	Value
p-	pico-	10^{-12}
n-	nano-	10^{-9}
μ -	micro-	10^{-6}
m-	milli-	10^{-3}
k-	kilo-	10^3
M-	mega-	10^6

°	degrees
Ω	ohms
+5 V (signal)	+5 VDC Source
A	amperes
AC	alternating current
A/D	analog-to-digital
Arms	amperes, root mean square
AWG	American Wire Gauge
C	Celsius
Chan	Channel signal
COM	Common signal
cps	counts per second
D/A	digital-to-analog
DAQ	data acquisition
DAQD*/A	Data Acquisition Board Data/Address Line signal
dB	decibels
DC	direct current
DIGGND	Digital Ground signal
DIN	Deutsche Industrie Norme
DIO	digital I/O
ESD	electrostatic discharge
FIFO	first-in-first-out
ft.	feet
GND	ground signal
hex	hexadecimal
Hz	hertz
I/O	input/output
ID	identification
I_L	input current leakage
in	inch
In	Digital Input signal
I_{in}	input current
I_{out}	output current

Glossary

LSB	least significant bit
max	maximum
MB	megabytes of memory
m	meters
min	minimum
MIO	multifunction I/O
MOV	metal oxide varistor
MSB	most significant bit
NC	No connect
RAM	random-access memory
rms	root mean square
RTSI	Real-Time System Integration
SCXI	Signal Conditioning eXtensions for Instrumentation (bus)
SDK	Software Developer's Kit
s	seconds
SERCLK	Serial Clock signal
SERDATIN	Serial Data In signal
SERDATOUT	Serial Data Out signal
SLOT0SEL*	Slot 0 Select signal
SPI	Serial Peripheral Interface
UL	Underwriters Laboratory
V	volts
VAC	volts alternating current
VDC	volts direct current
VI	virtual instrument
V_{IH}	volts input high
V_{IL}	volts input low
V_{in}	volts in
V_{OH}	volts output high
V_{OL}	volts output low
V_{out}	volts out
V_{rms}	volts, root mean square

Index

C

cables, custom, 1-5 to 1-6
CHAN<0..31> signals (table), 3-3
configuration. *See also* installation.
 connection to MIO-type or DIO-type
 DAQ boards, 2-2
 factory configuration, 2-1
 jumpers
 parts locator diagram, 2-3
 procedure for changing jumpers, 2-2
 rear signal connector, 3-6
 supplementary W4
 configuration, 2-5
 W2, W3 and W5 jumper
 configuration for DIO- and
 MIO-type boards (table), 2-4
 W4 and W6 jumper configuration
 for DIO- and MIO-type boards
 (table), 2-5
 parallel mode operation, 2-1
 serial mode operation, 2-1
custom cables, 1-5
customer communication, B-1

D

DAQD*/A signal (table), 3-8
DIGGND signal (table), 3-8
documentation
 conventions used in manual, *viii*
 National Instruments documentation
 set, *ix*
 organization of manual, *vii*
 related documentation, *ix*

E

electrical hazards (warning), 3-1
environment specifications, A-1
equipment, optional, 1-4 to 1-5

F

front connector
 optically isolated solid-state relay
 channels, 3-4
 pin assignments (illustration), 3-2
 relay protection of inductive load
 connections, 3-5
 signal descriptions (table), 3-3

G

GND signal (table), 3-9

H

hardware installation, 2-6

I

In<0..31> signal, (table), 3-9
inductive load connections, relay protection
 for, 3-5
initialization of relays, 3-4
installation. *See also* configuration.
 hardware installation, 2-6
 SCXI-1326 terminal block, 3-5 to 3-6
 unpacking the SCXI-1163R, 1-6

J

jumpers
 parts locator diagram, 2-3
 procedure for changing jumpers, 2-2
 rear signal connector, 3-6
 supplementary W4 configuration, 2-5
 W2, W3 and W5 jumper configuration
 for DIO- and MIO-type boards
 (table), 2-4

W4 and W6 jumper configuration for
DIO- and MIO-type boards (table), 2-5

L

LabVIEW and LabWindows software, 1-2

M

manual. *See* documentation.

N

NI-DAQ driver software, 1-2 to 1-4

O

optically isolated solid-state relay channels.
See relay channels.

P

parallel mode operation, 2-1 to 2-2
parts locator diagram, 2-3
physical specifications, A-1
pin assignments
 front connector (illustration), 3-2
 rear signal connector (illustration), 3-7

R

rear signal connector, 3-6 to 3-9
 configuration, 3-6
 pin assignments (illustration), 3-7
 signal descriptions
 parallel configuration (table), 3-9
 serial configuration (table), 3-8
register-level programming, 1-4
relay channels
 initialization, 3-4
 optically isolated solid-state relay
 channels, 3-4

protection for inductive load
 connections, 3-5
 relay connection diagram, 3-4
 specifications for solid-state relays, A-1

S

SCXI-1163R

capabilities, 1-1
custom cables, 1-5
kit contents, 1-1
optional equipment, 1-4 to 1-5
software programming choices, 1-2
 to 1-4
 LabVIEW and LabWindows
 software, 1-2
 NI-DAQ driver software, 1-2 to 1-4
 register-level programming, 1-4
unpacking, 1-6

SCXI-1326 terminal block, 3-5 to 3-6

SERCLK signal (table), 3-8

SERDATIN signal (table), 3-8

SERDATOUT signal (table), 3-8

serial mode operation, 2-1

signal connections

 electrical hazards (warning), 3-1

 front connector

 optically isolated solid-state relay
 channels, 3-3

 pin assignments (illustration), 3-2

 relay protection of inductive load
 connections, 3-5

 signal descriptions (table), 3-3

 rear signal connector, 3-6 to 3-9

 configuration, 3-6

 pin assignments (illustration), 3-7

 signal descriptions

 parallel configuration (table), 3-9

 serial configuration (table), 3-8

 terminal block, 3-5 to 3-6

SLOT0SEL* signal (table), 3-8

software programming choices, 1-2 to 1-4
 LabVIEW and LabWindows software,
 1-2 to 1-3

 NI-DAQ driver software, 1-2 to 1-4

 register-level programming, 1-4

solid-state relay channels. *See* relay
channels.

specifications
 environment, A-1
 physical, A-1
 solid-state relays, A-1

T

technical support, B-1
terminal block, 3-5 to 3-6

U

unpacking the SCXI-1163R, 1-6

