



TWIN-N

(2+2 A, 5+5 A, 8+8 A)

SPD-N

(2A, 5A, 8A, 16A)

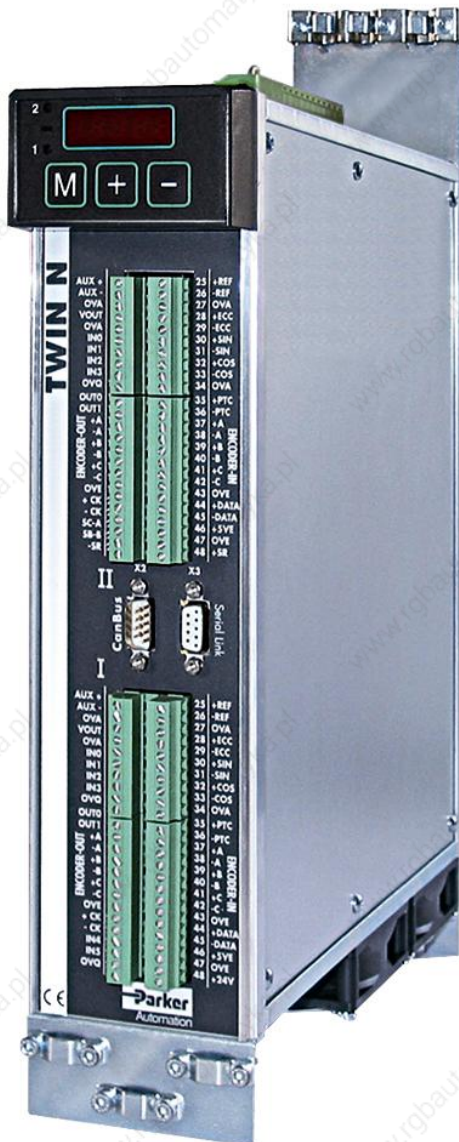

User's manual

Rev. 0.4
October 2010



This user manual is for the standard version of the converter.

All information in this user manual, including methods, techniques and concepts described herein, are proprietary information of Parker Hannifin Divisione S.B.C. – EME Division and of its licensees, and they shall not be copied or used without express authorization.

Parker Hannifin S.p.A. Divisione S.B.C. is committed to a continuous product upgrade and reserves the right to modify products and user manuals at any time without prior notice. No part of this user manual may be howsoever reproduced without previous consent by Parker Hannifin S.p.A. Divisione S.B.C..

Abbreviations

FBK	Feedback.
Pr...	Decimal parameter.
b...	Binary parameter (bit).
FFW	Feedforward, control advance function.
R	Read parameter.
W	Write parameter.
Keypad-display	Keypad
Drive	Converter

Cod 1010111700

Index:

1	INTRODUCTION	7
1.1	General information	7
1.2	Product description.....	7
1.3	Identification.....	8
1.4	Safety instructions.....	10
1.4.1	Symbols and signals.....	10
1.4.2	General information	10
1.4.3	Safety instructions for transportation and storage.....	11
1.4.4	Safety instructions for commissioning.....	11
1.4.5	Safety instructions for operation	12
1.4.6	Safety instructions for maintenance.....	13
1.4.7	Compatibility with RCD devices	13
1.4.8	Applicable standards	14
1.4.9	Materials and disposal.....	14
1.4.10	Warranty.....	15
1.5	Main hardware features	15
1.5.1	Ambient conditions	15
1.5.2	Technical data	16
1.6	Main software features	18
1.7	Expansibility: the Parker-SBC Bridge and its philosophy	18
2	MOUNTING	20
2.1	How to suppress interference.....	20
2.1.1	Grounding	20
2.1.2	Cable connections and shielding.....	21
2.1.3	General suggestions on cable connections.....	21
2.1.4	Mains and motor side filters.....	23
2.2	Signal connectors layout.....	24
2.3	Connections	26
2.4	Ground connections (PE)	27
2.5	Line connection diagrams	28
2.6	Motor connection diagrams	29
2.7	Resolver connection diagrams	29
2.8	Signal cables connection	29

2.9	Encoder connection	30
2.10	Encoder sinusoidal + EnDat connection	31
2.11	Encoder sinusoidal + Hiperface connection	32
2.12	Incremental encoder + HALL sensor	33
2.13	SinCos (one sin wave per pole pitch)	34
2.14	Frequency input/output connection	35
2.14.1	Connecting the drive to the digital-lock.....	36
2.15	Serial line connection	37
2.16	CAN line connection	38
2.17	External +24V power supply for the control stage	38
2.18	External braking resistance	39
3	USING THE KEYBOARD	40
4	POWER SUPPLY MODE	42
4.1	“Low” voltage power supply	42
4.2	“High” voltage power supply	43
5	START-UP	44
5.1	Setting the default parameters	44
5.2	Selection of motor type	44
5.3	Changing motor data	45
5.4	Setting feedback	45
5.4.1	Feedback configuration.....	46
5.4.2	Select supply feedback.....	46
5.5	Feedback from SinCos encoder or SinCsos + Endat encoder	47
5.6	Feedback from incremental encoder	48
5.7	Encoder phasing	48
5.7.1	Type 1 phasing.....	48
5.7.2	Type 2 phasing.....	49
5.8	First commissioning	50
5.9	Speed control adjustment	51

6	PARAMETERS AND PROGRAMMING	57
6.1	Main parameters	60
6.2	Binary parameters	65
7	OPERATING MODES	70
7.1	Position control.....	71
7.2	Torque control (operating mode 1)	74
7.3	Digital Lock + Positioner (operating mode 13)	75
7.3.1	TAB0: profiles in memory	75
7.4	Electronic cam (operating mode 14).....	79
7.4.1	Positioning	79
7.4.2	Speed mode	80
7.4.3	Electronic cam.....	80
7.4.4	OPM 14 Linear engage CAM	86
7.5	Electronic cam (op. mod. 11).....	88
7.5.1	Positionator	89
7.5.2	CAM1 and CAM2.....	89
7.5.2.1	Automatic activation of CAM tables	93
7.6	Position control through the CANbus (operating mode 15)	100
7.7	Basic functions.....	103
7.7.1	Homing function	103
7.7.2	Speed adjustment	104
7.7.3	Current or torque adjustment (typical).....	104
7.7.4	Frequency input/output (Encoder ports)	104
7.7.5	Value comparators	105
7.7.6	Value capture	105
7.7.7	Output programmable on module	105
7.7.8	Analogue output programmable.....	106
7.7.9	Master reference.....	106
7.7.10	Encoder CAN.....	107
8	PROGRAMMING DIGITAL INPUTS/OUTPUTS	109
8.1	The pico-PLC	109
8.2	Programming with MotionWiz.....	114
8.3	MotionWiz	115
9	SERIAL INTERFACE	116
9.1	Communication protocol.....	116

10	CAN BUS INTERFACE	121
10.1	SBC CAN	121
10.1.1	Description of the fields in real time mode	122
10.1.2	Description of the fields in communication mode	129
10.1.3	Description of the fields Extended message set # 2	131
10.2	CANopen (C version).....	133
10.3	CANopen dsp402 (D version).....	141
10.3.1	Dictionary object summary of ds301 in drive.....	142
10.3.2	Dictionary object summary of dsp402 in drive.....	143
10.3.2.1	Object 6040h: Controlword	146
10.3.2.2	Object 6041h: Statusword	148
10.3.2.3	Object 605Bh: Shutdown option code	150
10.3.2.4	Object 605Ch: Disable operation option code	151
10.3.2.5	Object 605Ah: Quick stop option code	152
10.3.2.6	Object 605Eh: Fault reaction option code.....	152
10.3.2.7	Object 6060h: Modes of operation.....	153
10.3.2.8	Object 6061h: Modes of operation display	153
10.3.3	Functional description.....	154
10.3.3.1	Modes of operation function	154
10.3.4	Homing mode (operative mode 200)	155
10.3.5	General information	155
10.3.5.1	Input data description.....	155
10.3.5.2	Output data description	156
10.3.5.3	Internal states	156
10.3.5.3.1	Controlword of homing mode.....	156
10.3.5.3.2	Statusword of homing mode	156
10.3.6	Object dictionary entries	157
10.3.6.1	Objects defined in this chapter.....	157
10.3.6.2	Objects defined in other chapters.....	157
10.3.7	Object description	157
10.3.7.1	Object 607Ch: <i>Home offset</i>	157
10.3.7.2	Object 6098h: <i>Homing method</i>	158
10.3.7.3	Object 6099h: <i>Homing speeds</i>	158
10.3.7.4	Object 609Ah: Homing acceleration.....	159
10.3.8	Functional description.....	160
10.3.8.1	Homing methods.....	160
10.3.8.1.1	Method 1: Homing on the negative limit switch and index pulse	160
10.3.8.1.2	Method 2: Homing on the positive limit switch and index pulse	161
10.3.8.1.3	Methods 3 and 4: Homing on the positive home switch and index pul.	161
10.3.8.1.4	Methods 5 and 6: Homing on the negative home switch and index pul.	162
10.3.8.1.5	Methods 7 to 14: Homing on the home switch and index pulse.....	162
10.3.8.1.6	Methods 15 and 16: Reserved.....	163
10.3.8.1.7	Methods 17 to 30: Homing without an index pulse	164
10.3.8.1.8	Methods 31 and 32: Reserved.....	164
10.3.8.1.9	Methods 33 to 34: Homing on the index pulse	164
10.3.8.1.10	Method 35: Homing on the current position	164
10.3.9	Profile position mode (operative mode 201).....	165
10.3.9.1	Internal states	165

10.3.9.1.1	Controlword of profile position mode	165
10.3.9.1.2	Statusword of profile position mode	165
10.3.9.2	Object dictionary entries	166
10.3.9.2.1	Objects defined in this chapter	166
10.3.9.2.2	Object 607Ah: Target position	166
10.3.9.2.3	Object 6081h: Profile velocity	167
10.3.9.2.4	Object 6083h: Profile acceleration/deceleration	167
10.3.9.2.5	Object 6085h: Quick stop deceleration	168
10.3.9.2.6	Object 6086h: Motion profile type	168
10.3.9.3	Functional description	169
10.3.9.4	Functional description	170
10.3.10	Interpolated Position Mode (operative mode 202)	172
10.3.10.1	Object 60C0h: Interpolation sub mode select	173
10.3.10.2	Object 60C1h: Interpolation data record	173
10.3.11	Drive parameters	176
11	APPENDIX A: MECHANICAL DIMENSIONS	177
12	APPENDIX B: CONVENTIONS	178
13	APPENDIX C: SOFTWARE TIMING	178
14	APPENDIX D: DEFAULT PROGRAM FOR PICO-PLC	179
15	APPENDIX E: FLASH INFORMATION	180
16	APPENDIX F: ALARMS	181
17	APPENDIX G: OPTION "R" FOR SAFE DISABLE FUNCTION	183
17.1	Introduction	183
17.2	Signals description	184
17.3	Drive function blocks	186
17.4	Connections	187
17.5	Operation, sequence and timing	187
17.6	Example	189
17.7	Test and maintenance	189
18	REVISION HISTORY OF THE USER MANUAL	190

1 INTRODUCTION

1.1 General information

This manual describes the installation and commissioning of the frequency converter TWIN-N/SPD-N for brushless motors.

Read carefully all the sections.

1.2 Product description

The TWIN-N/SPD-N is a digital frequency converter for brushless motors and asynchronous motors with feedback. The operator interface based on parameters makes it easy to configure the converter. Configurations of different kinds make suitable it for many applications.

The TWIN-N converter allows controlling two brushless motors with a single converter. This feature allows saving space into the electric panel in multi-axis configurations. Actually, they are two different converters that can be used in a totally independent way.

The SPD-N drive is the version to single axis.

The drive features a series of integrated auxiliary functions that allow minimising the control electronics in the applications, with a considerable cost saving.

It uses widely diffused industrial programming standards and guarantees a high degree of freedom in selecting inputs and outputs. The drive also offers the possibility to develop additional functions that are not included in the basic functionality of the converter such as gain correction for loops based on speed or space, monitoring the used torque for tool life control, etc.

It can be configured through the serial keypad, the serial line or the CAN bus

1.3 Identification

The converters of the TWIN-N series are available in 3 models: TWIN 2N, TWIN 5N and TWIN 8N. The number that follows the TWIN-N abbreviation corresponds to the rated current of the converter in amperes.

Use the following table to specify the order code:

TWIN		2	N	S			
	X	5		C	E	Y1	R
		8		D	H		
					F		

The converters of the SPD-N series are available in 4 models: SPD 2N, SPD 5N, SPD 8N and SPD16N. The number that follows the SPD -N abbreviation corresponds to the rated current of the converter in amperes.

Use the following table to specify the order code:

SPD		2	N	S			
	X	5		C	E	Y1	R
		8		D	H		
		16			F		

Where :

TWIN / SPD	TWIN / SPD servodrive series
X	ATEX type drive
2	drive size (nominal current, up to 1 digit: 2, 5, 8, 16)
N	New series
S	SBC Can protocol (standard)
C	CAN Open protocol (DS301)
D	CAN Open protocol (DS402)
	Resolver
E	EnDat/incremental/sinc encoder input (from motor feedback)
H	Incremental encoder+hall sensors input (from motor feedback)
F	SinCos (one wave per pole pitch)
Y1	Optional board
R	Internal safety relay

A label is attached on the right side of the converter that contains all the essential information to correctly identify the unit:

- Serial number
- Model
- Nominal plate data

It is important to refer to this label before requesting any kind of technical information from Parker Hannifin S.p.A S.B.C. Division

An example of this label is given below.

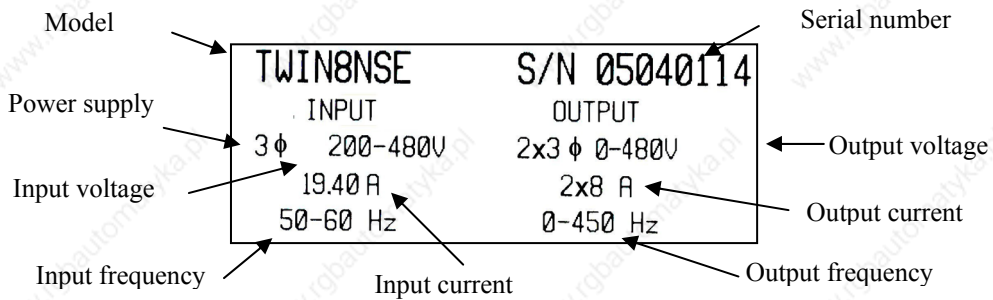
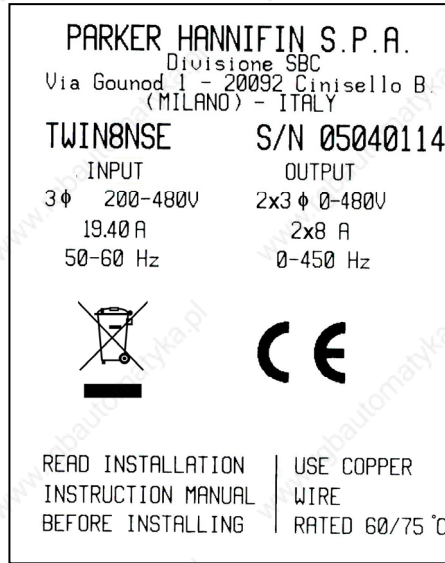

The performance of converter is guaranteed only with synchronous motors with permanent magnets MB and SMB Series that have been manufactured by us.

1.4 Safety instructions

1.4.1 Symbols and signals

Several symbols and signals are used in this safety instruction.

Pay attention to the following meanings :

DANGER

Extremely severe risk. Disregarding the following advise may involve danger of life.

WARNING

Severe risk. Disregarding the following advise may involve serious personal injury.

CAUTION

Medium risk. Disregarding the following advise may involve personal injury

1.4.2 General information

- Only persons who are qualified and trained for the use and operation of the equipment may work on this equipment or within its proximity. The persons are qualified if they have sufficient knowledge of the assembly, transportation, installation and operation of the equipment as well as an understanding of all warnings and precautionary measures noted in these instructions. The user must also observe local safety regulations.
- Before installing and commissioning the drive, read carefully this documentation and strictly observe all technical, safety and wiring information, including identifying labels placed on the drive (ratings). In case of doubt contact the Parker Hannifin service centre.
- Drives are to be intended as components for use in machine or systems. Therefore they can be used only in machine or systems that are in compliance with the low voltage directive 73/23/CEE (modified by 93/68/CEE) and with the electro-magnetic compatibility directive 89/336/CEE.
- Electronic equipments are generally not “fail-safe” components. Therefore the machine manufacturers should carry out a risk analysis for the whole machine in order to ensure that moving parts (motors) cannot bring personal injury in case of failures of electronic devices.

1.4.3 Safety instructions for transportation and storage

- The ambient conditions given in the product documentation must be observed for transportation and storage (temperature, humidity, mechanical stress and aggressive atmosphere).
- Drives contain components sensitive to electrostatic charges which can be damaged by inappropriate handling. Therefore during installation / removal of drives, provide the necessary safety precautions against electrostatic discharges (discharge electrostatic charges of the human body before touching the drive, always place the drive above conductive plates and avoid touching it with insulating material like synthetic fibres, polymeric materials etc...)



WARNING

Risk of injury by incorrect handling !

- Incorrect handling of the equipment may cause severe personal injury. Use appropriate tools for transportation, lifting, handling and mounting. Wear appropriate clothing for accident-prevention (safety shoes, safety glasses, safety gloves, etc...).

1.4.4 Safety instructions for commissioning



DANGER

- The high voltages inside the drive imply risk of electric shock. Make sure that drive and motor are properly grounded accordingly to national regulations. Furthermore the drive, before switching it on, must be closed in a protective cabinet in order to avoid direct contact with accessible live parts.
- Only qualified and trained personnel is allowed to perform installation and commissioning, using appropriate tools and following the safety precautions given in this instruction. Make sure that supply voltage has been switched off before installing and wiring.
- Drives are only allowed to be operated on TT, TN grounded industrial mains having maximum 480V+10% line to line rms voltage, as specified in the user manual. Do not directly install the drive on ungrounded (IT) or asymmetrically grounded mains. In case of ungrounded mains, coupling with Dyn transformer with grounded secondary circuit is necessary. Refer to drive technical data and wiring instruction.
- All the components used in the cabinet in which the drive is installed, (cables, contactors, inductors and transformers, fuses, etc...), and the connected motor, must be in compliance with the specification given in the product documentation, in addition to national regulations. Make sure that the maximum temperature inside the cabinet does not exceed 45°C (113°F). If necessary, use an appropriate air conditioning.
- The size and temperature rating of wires and cables used for connecting the drive must be in compliance with the specification given in the instruction manual (see NEC 310-16 for USA). Use also the specified tightening torque.
- Make sure about the correct drive-motor matching: voltage and current ratings must be compatible.
- The user is responsible for over-current and short circuit protection of the drive. Read carefully the specification given in the user manual.

1.4.5 Safety instructions for operation



DANGER

High voltage ! Risk of electric shock ! Danger of life !

- All live parts must be protected against direct contact. The drive must be closed inside a cabinet before switching it on.
- Working on power live parts (terminals) must be conducted with the drive switched-off. Dangerous voltages may be present at power terminals even after the supply has been switched off and the motor stopped. Make sure the equipment cannot be switched on unintentionally. Wait at least 6 minutes before working on live parts after the unit has been switched-off.
- The drive and the motor must be permanently connected to earth accordingly to the connection diagram, even for brief measurements or tests.



DANGER

High leakage current ! Risk of electric shock ! Danger of life !

- Earth leakage current during operation may exceed 3,5 mA AC or 10mA DC.
- Earth connection must be permanent : use copper wire having a minimum size of 10mm² throughout all the length.
- Before switching the equipment on, make sure that all devices, including the motor, are permanently connected to earth, even for brief test or measurements, as shown in the wiring diagrams. Otherwise high voltages may appear on equipment conductive surfaces with danger of electrical shock.
- Always refer to current local regulations for grounding. For installation within European Community refer to EN61800-5-1 product standard, section 4.2.5.4.2. For installation in the USA refer to NEC (National Electric Code) and NEMA (National Electric Manufacturers Association). The product installation should always comply with the above said standards.



WARNING

Hot surfaces ! Danger of injury ! Danger of burns !

- Some external surfaces of the equipment and some internal part may reach very high temperatures. Danger of burn and injury if touching these parts.
- After switching the equipment , wait at least 15 minutes to allow it to cool before touching it.



DANGER

Dangerous movements ! Danger of life !

- Dangerous movements can be caused by faulty control of the connected motor.
Same common example are :
 - Improper or wrong installation and wiring
 - Wrong input parameters before or during operation (programming)
 - Defective components (drive, motor, wires, sensors, etc...)
 - Incorrect control (software or firmware errors)
- In order to prevent personal injury due to unintended dangerous motor movements, pay the maximum attention and work on the machine with a qualified and tested safety system :
 - Isolate the drive power connection.
 - Mount the emergency stop switch in the immediate reach of the operator. Verify that the emergency stop works before start-up. Don't operate the machine if the emergency stop is not working.
 - Install properly fences, guards, coverings and light barriers in order to prevent people from accidentally entering the machine's range of motion.
 - Secure vertical axes against falling or dropping after switching off the motor power
 - Make sure that the drives are brought to a safe standstill before accessing or entering the danger zone.

1.4.6 Safety instructions for maintenance



WARNING

- It is extremely dangerous to remove covers or part of the external enclosure from the equipment. Risk of personal injury. The warranty immediately decay.
- In case of malfunction consult the alarm list described in the user manual or address Parker Hannifin. The drives are not field repairable.

1.4.7 Compatibility with RCD devices



CAUTION

The use of RCD (Residual Current Devices) is strongly not recommended.

If the use of RCD is mandatory, use type B only (for DC and AC prospective earth current). Set the trip level at 300mA (fire protection level) or more.

Setting the trip level at 30mA (protection level against direct contact) is possible only using time-delayed RCD and low leakage current EMC filters, but in any case the drives are not guaranteed to operate with 30mA trip level.

1.4.8 Applicable standards

Safety

2006/95/EC	Low voltage directive
EN61800-5-1	Adjustable speed electrical power drive systems - Part 5-1: Safety requirements- Electrical, thermal and energy
UL508C	(USA) Power Conversion Equipment
CSA22.2 Nr. 14-05	(Canada) Power Conversion Equipment

The drive is CE marked in accordance with the Low Voltage Directive when installed and operated with reference to the product manual.

The drive is considered as a component in machinery. The complete machinery or installation may only be put into service when in accordance with the safety considerations of the Machinery Directive 2006/42/EC.

Electromagnetic Compatibility (Immunity/Emission)

2004/108/EC	EMC directive
EN 61800-3	Adjustable speed electrical power drive systems - Part 3: EMC requirements and specific test methods

The drives are intended as components to be used in a second environment (industrial environment) and category C3, together with specific EMC filters and installed accordingly to the recommendations given in the user manual. When used in the first environment (residential / commercial environment), drives may produce radio-frequency interference dangerous for other equipment: additional filtering measures must be implemented by the user.

1.4.9 Materials and disposal

- zinc coated steel sheet, thickness 1mm and 2mm
- extruded aluminium AlSi
- ABS thickness 2mm minimum (keypad)
- adhesive polycarbonate (front label)

Electrolytic capacitor contain electrolyte and printed circuit boards contain lead, both of which are classified as hazardous waste and must be removed and handled according to local regulations.



The S.B.C. division of the Parker Hannifin Company, together with local distributors and in accordance with EU standard 2002/96/EC, undertakes to withdraw and dispose of its products, fully respecting environmental considerations.

1.4.10 Warranty

The warranty duration is 1 (one) year. The converter must not be opened, accessed or modified in any of its part. Any attempt to do so would cause the 1-year warranty to be cancelled with immediate effect.. Parker Hannifin declines any responsibility for damages that may be caused by inappropriate use of the converter.

1.5 Main hardware features

1.5.1 Ambient conditions

temperature	operation	0 ... 45 °C 32 ... 113 °F
	storage (1K4 class)	-20 ... 55 °C -4 ... 131 °F
	transportation (2K3 class)	-25 ... 70 °C -13 ... 158 °F
humidity (3K3 class)	relative	< 85% without ice and condensation
	absolute	< 25 g/m ³
altitude (*)		≤ 1000 m slm ≤ 3281 feet asl
Protection degree		IP20 (only in close electric cabinet) UL open type equipment
Pollution degree		2 or lower (no conductive dust allowed)

(*) For higher installation altitude, derate the output current by 1.5% each 100m up to 2000m maximum

1.5.2 Technical data

Item	Unit	Model			
		TWIN2N	TWIN5N	TWIN8N	-
		SPD2N	SPD5N	SPD8N	SPD16N
<i>Power stage</i>					
Mains frequency	Hz	50 - 60 ± 5%			
3-phase voltage range	V~	200-10% ... 480+10%			
1-phase voltage range	V~	200-10% ... 277+10%			
DC voltage range	V=	282-10% ... 678+10%			
Rated output current (*)	A rms	2	5	8	16
Peak output current (2 sec) (*)	A rms	4	10	16	32 (24@8kHz)
Shaft power (*)	kW	1,0	2,6	4,2	7,5
Continuous service installed load (*)	kVA	1,4	3,5	5,6	11,2
Control electronics dissipation (*)	W	25	60	88	180
Internal fan capacity	m ³ /h	135			
Switching frequency	kHz	8			4
Output frequency	Hz	0 ÷ 450			
<i>intermediate DC circuit and dynamic braking</i>					
Continuous internal braking power	W	120			
Peak internal braking power	kW	16,2			
Braking resistor internal / external	Ω	40			
Max peak braking current	A	20			
Max rms braking current (internal resistance)	A	0,15			
Max duty cycle (internal resistance)	%	0,75			
Internal DC capacitors	μF	470 ±20%			680 ±20%
Braking threshold	Vdc	805 - 780			
Overvoltage level	Vdc	870			
Undervoltage level	Vdc	70% * √2 * V _{supply}			
<i>Control stage</i>					
Supply voltage	V =	24 (-0% ... +10%)			
Max ripple	V pk-pk	<i>Do not go over the range</i>			
Current rating of the external power supply	A	2			
Control electronics dissipation	W	25			
EMC Filter	-	internal			
<i>Hardware characteristics</i>					
Feedback	-	TWIN-N SPD-N		TWIN-NE SPD-NE	
		Resolver		Encoder	
Auxiliary Encoder	-	in quadrature encoder (coupled)			
Max Frequency	kHz	400			
RS-422 encoder simulation	step/rev	4÷65000			
Max Frequency	kHz	160			
Serial link	-	RS-422 / RS-485			
Field bus	-	CAN ISO/DIS11898			

(*) the value for TWIN-N is for single axis.

<i>Digital inputs</i>		
type	-	Opto coupled
number (each single axis)	nr.	4
number (shared by the two axe)	nr.	2 (IN4,IN5)
input impedance	k Ω	2.8
Input High voltage range	V	24 \pm 10%
Input Low voltage range	V	0÷5
Type of driving required	-	PNP
Reaction time	μ s	< 8
<i>Digital outputs</i>		
type	-	Opto coupled, PNP open collector
number (each single axis)	nr.	2
Output High voltage range	V	> ($V_{\text{supply}}-1$)
Output Low voltage range	V	<1
corrente massima per singola uscita	mA	100
Overload / Short circuit protection	-	yes
internal pull-down	k Ω	20
<i>Analog reference</i>		
Type	-	Differential
number (each single axis)	nr.	1
voltage	V	\pm 10
CMR	dB	>80
resolution	bit	15 + sign
input impedance	k Ω	>18
max frequency	kHz	2
<i>Auxiliary analogue input</i>		
Type	-	Differential
number (each single axis)	nr.	1
voltage	V	\pm 10
CMR	dB	>80
resolution	bit	10
input impedance	k Ω	>18
max frequency	kHz	2
<i>Analog output</i>		
type	-	single ended (refer to 0VA)
number (each single axis)	nr.	1
voltage	V	\pm 10
max current	mA	1.5
resolution	bit	10
Overload / Short circuit protection	-	yes

1.6 Main software features

The following functions have been implemented in the basic software:

Speed controller

Advanced manager of torque limits

Management of speed windows

Torque motor control

Torque control with speed control overlaying

Positioning with trapezoidal Speed profiles

Provides the functions of an electrical shaft with variable ratio and phase correction

Electronic cam

Simulates a stepper motor

It is provided with an internal PLC for programming inputs/outputs

Serial interface RS422-485 integrated: TWIN-N has two independent nodes

Can bus interface: TWIN-N has two independent nodes.

1.7 Expansibility: the Parker-SBC Bridge and its philosophy

Manufacturing companies of machines that use “servo” motor drives frequently have the need of combining the PLC with the axis control.

The two programmable components are often heterogeneous; the first one sees to the machine logics management, whereas the second one sees top the motor motion profile management. The skills required to manage the two products are so different that they require different persons, with a consequent increase of costs and new problems to manage, that is, the interface between two non-homogeneous worlds.

Besides having all of the features required by the market of a servo converter, the Parker-S.B.C. drives for brushless motors are also capable of executing “motion” functions that can be used for a large number of applications, without having the typical need of programming an axis control. Their feature is that they can operate as “MOTION ENGINE”, that is, with a component that commands the motor to execute the desired motion profile, while the MACHINE LOGICS is still managed by the PLC or by the machine PC.

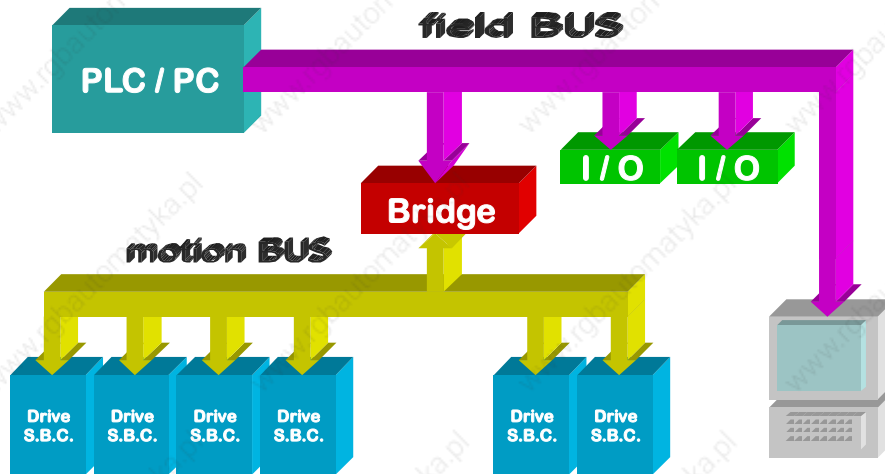

The group of converters used for an application become a single peripheral unit of the PLC/PC using standard FIELD BUS (Profibus or DeviceNet), and the architecture of the plant control system becomes of the type shown in the figure.

With the Bridge philosophy, the user or the manufacturer can write motion programs using a standard PLC, thus avoiding to realise specific application communication protocols.

This philosophy aims at allowing the manufacturer to reach his goals, in terms of time-to-market, allowing him to focus the efforts on the design activity and avoiding multiple problems connected to the drive use and interfacing.

2 MOUNTING

- The converter must be mounted vertically with the power block
- A space of at least 100 mm. must be left free above and beneath the converter.

2.1 How to suppress interference

For the drive to meet the product requirements regarding electromagnetic compatibility, the installation must be carried out according to the following instructions.

Because of strong PWM voltage fronts, undesirable currents of significant force can sometimes circulate through capacitive couplings and grounding systems (conducted interference). Besides, also high frequency interferes in the form of radiation, especially through the motor cable, in free space are generated (radiated interference).

The reduction/suppression of both conducted and radiated interference can be obtained through grounding, shielding and filtering. In particular filters reduce the interference conducted in the cables and the return of interference conducted at the source (the frequency converter) by using paths with the lowest possible impedance. In this way other systems connected to the same electrical line can be protected effectively and the frequency converter will also be protected from the interference of other systems.

Basically, the criteria are essentially based on grounding, filtering and shielding.

2.1.1 Grounding

In the electric panels where the drives are usually installed there are two ground systems:

- EMC ground, or HF reference (high frequency), represented by the wall made of non-painted metal, onto which drives and filters are fixed.
- The safety ground, or PE (protective earth), according to the EN60204-1 standard

Fix drive and mains filters, the 24Vdc power supply etc. on the metal wall, making sure that there is a proper electric contact (HF connection).

Carry the safety ground using cables having a minimum section of 10mm²

2.1.2 Cable connections and shielding

With the exception of mains cables to the filter, all power and control cables must be shielded and, wherever possible, kept segregated (minimum distance 20 cm). If control and power cables must cross, the intersection must be at a right angle.

The shielded cables must be unbroken and grounded to a copper bar using the cable clamps connections as shown in the drawing (at 360°) in order to obtain a good conductivity.

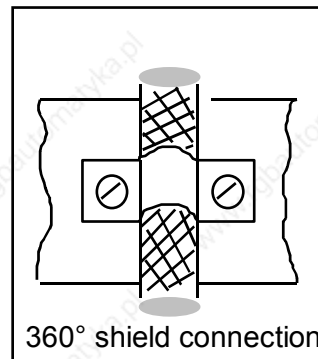

In general the shield should be connected at each extremity. In certain circumstances, however, control cable shields may be connected only at one end to eliminate mains hum that could interfere with the control signal. Decide case by case as numerous factors must be considered. Adopt the following general approach: if the screen is solely for shielding, connect at both ends. If current flowing in the shield interferes with the shielded signals, connect at one end only.

The incoming cable must be connected to an earth terminal by means of a screw to ensure proper contact between screen and earth.

As far as possible keep the power side (drive) and control side (PLC or NC) physically separated by separating the metal mounting plates. Inside the electrical cabinet, the two plates must be connected through a copper strap.

2.1.3 General suggestions on cable connections

Avoid routing noise emitting cables in parallel with "clean" cables

Avoid parallel cables, especially in the vicinity of the filter (ensure physical separation)

Avoid cable loops (keep cables as short as possible and close to the common potential).

In particular, keep the main cables separate from motor cables.

If the motor is of the embedded brake type, keep the 24Vdc brake cables separate from the other cables (resolver and motor).

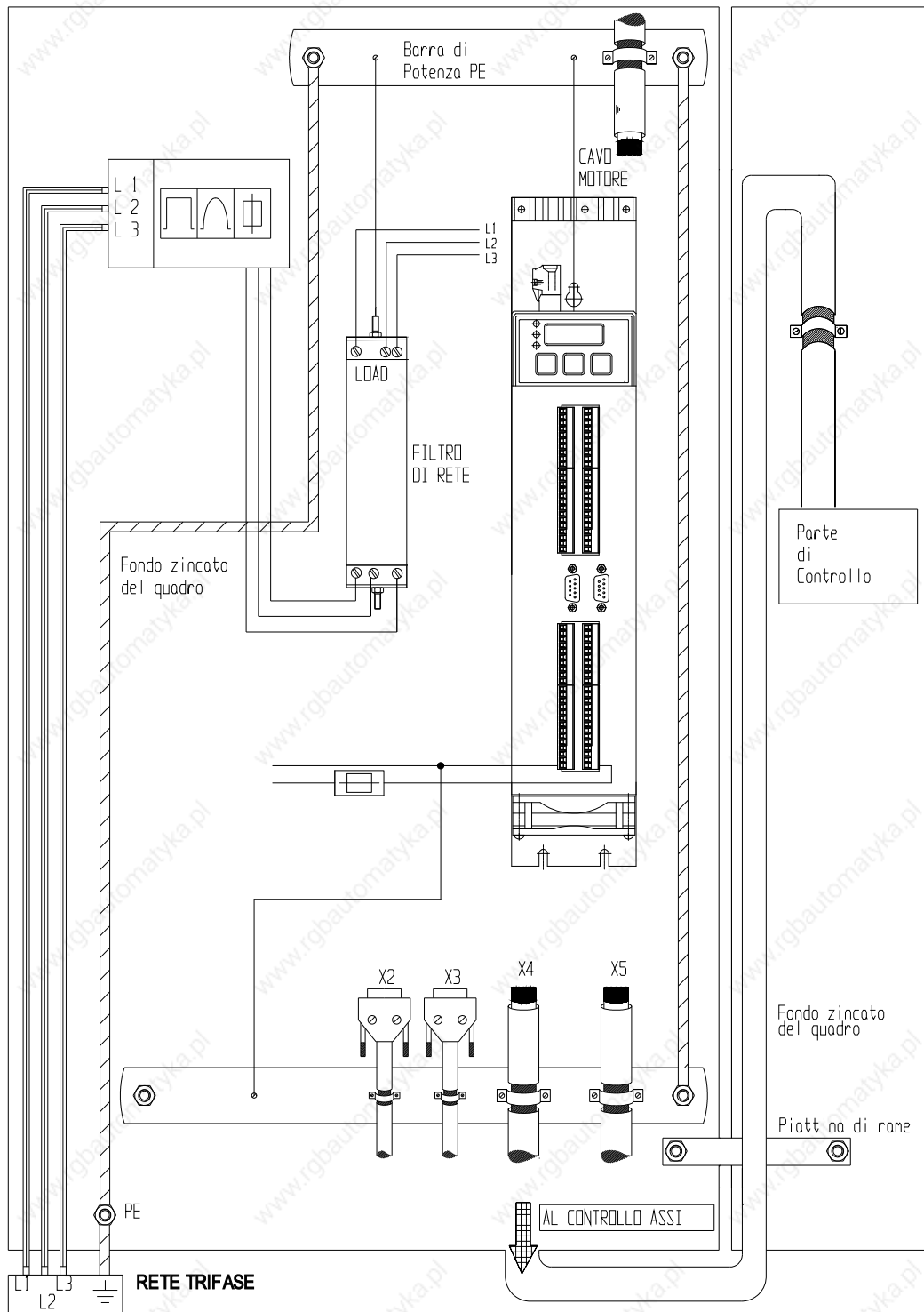

* The PE bar (for power grounding) must be mounted directly in contact; insulated columns are not to be used.

** The signal cable shields can be connected to a bar (HF) different from the PE bar or connected directly the metallic cable clamps to electrical cabinet back-plate.

*** In the “Cable connections” par. it is possible see every detail of this image.

2.1.4 Mains and motor side filters

It is usually necessary to use external filters in addition to internal filters the drive is provided with, on the mains input and sometimes on the motor output.

The mains filter must be mounted as close as possible to the drive and on the same drive panel, and must have a large area of contact with the power panel or the mounting plate.

If distance exceeds 30cm, the effect decreases and a screened cable must be used between filter and converter.

The filter earth terminal must be connected to the earth bar along the shortest possible route.

The converter-filter connection cable length should not be over 30cm in order to maximise efficiency.

2.2 Signal connectors layout

Power terminal connections		
1	L1	LINE
2	L2	
3	L3	
4	earth	MOTOR I
5	U-I	
6	V-I	
7	W-I	
8	earth	MOTOR II (<i>only TWIN-N</i>)
9	U-II	
10	V-II	
11	W-II	
12	+BUS	BUS CONFIGURATION
13	Int-res	
14	Com-brk	
15	-BUS	

I axis terminal connections			
1	Rif. AUX +	Rif. Analog +	25
2	Rif. AUX -	Rif. Analog -	26
3	0VA (0V Analog)	0VA (0V Analog)	27
4	Vout	ECC+	28
5	0VA (0V Analog)	ECC-	29
6	IN0	SIN+	30
7	IN1	SIN-	31
8	IN2	COS+	32
9	IN3	COS-	33
10	0VQ (0V Quadro)	0VA (0V Analog)	34
11	OUT0	PTC+	35
12	OUT1	PTC-	36
13	A+ ENCODER OUT	A+ ENCODER IN	37
14	A- ENCODER OUT	A- ENCODER IN	38
15	B+ ENCODER OUT	B+ ENCODER IN	39
16	B- ENCODER OUT	B- ENCODER IN	40
17	C+ ENCODER OUT	C+ ENCODER IN	41
18	C- ENCODER OUT	C- ENCODER IN	42
19	0VE (0V Encoder)	0VE (0V Encoder)	43
20	CK+	DATA+	44
21	CK-	DATA-	45
22	IN4	+ 5VE (Supply ENCODER)	46
23	IN5	0VE (0V Encoder)	47
24	0VQ 0V SUPPLY	+24V IN SUPPLY	48

II axis terminal connections (only TWIN-N)			
1	Rif. AUX +	Rif. Analog +	25
2	Rif. AUX -	Rif. Analog -	26
3	0VA (0V Analog)	0VA (0V Analog)	27
4	Vout	ECC+	28
5	0VA (0V Analog)	ECC-	29
6	IN0	SIN+	30
7	IN1	SIN-	31
8	IN2	COS+	32
9	IN3	COS-	33
10	0VQ (0V Quadro)	0VA (0V Analog)	34
11	OUT0	PTC+	35
12	OUT1	PTC-	36
13	A+ ENCODER OUT	A+ ENCODER IN	37
14	A- ENCODER OUT	A- ENCODER IN	38
15	B+ ENCODER OUT	B+ ENCODER IN	39
16	B- ENCODER OUT	B- ENCODER IN	40
17	C+ ENCODER OUT	C+ ENCODER IN	41
18	C- ENCODER OUT	C- ENCODER IN	42
19	0VE (0V Encoder)	0VE (0V Encoder)	43
20	CK+	DATA+	44
21	CK-	DATA-	45
22	SC-A FEEDBACK	+ 5VE (Supply. ENCODER)	46
23	SC-B FEEDBACK	0VE (0V Encoder)	47
24	-SR	+SR	48

II axis terminal connections (only SPD-N)			
22	SC-A FEEDBACK	+ 5VE (Supply. ENCODER)	46
23	SC-B FEEDBACK	0VE (0V Encoder)	47
24	-SR	+SR	48

X2 CAN bus (DB9 male)		
N. Pin	Signal	Description
1	Reserved	
2	CAN_L	Low communication line
3	CAN_GND	CAN ground
4	Reserved	
5	CAN_SHLD	Shield optional
6	CAN_GND	CAN ground optional
7	CAN_H	High communication line
8	Reserved	
9	Reserved	

X3 Serial 422/485 (DB9 female)	
N. Pin	Signal
1	TX
2	RX
3	/TX
4	/RX
5	reserved
6	+BR
7	reserved
8	reserved
9	0 V

2.3 Connections

Power cable specifications

- Maximum length 35m
- mobile or fixed installation depending on the applications
- max. conductor capacity 150pF/m

Cross section

TWIN-N		2A+2A	5A+5A	8A+8°
Power terminal block	Mains	2 mm ² (AWG14)	2,5 mm ² (AWG12)	4 mm ² (AWG10)
	Motor	1,5 mm ² (AWG14)	1,5 mm ² (AWG14)	2,5 mm ² (AWG12)
SPD-N		2A e 5A	8A	16°
Power terminal block	Mains	2 mm ² (AWG14)	2,5 mm ² (AWG12)	4 mm ² (AWG10)
	Motor	1,5 mm ² (AWG14)		
Terminal block I and II		0,22 ÷ 1 mm ² (AWG16)		

Tightening torques

Power terminal block	0.5 ÷ 0.6 Nm (M3)
Terminal block I and II	0.22 ÷ 0.25 Nm (M2)

Fuses

Drive	Time-delayed fuses
TWIN2N, SPD2N, SPD5N	10 A
TWIN5N, SPD8N	20 A
TWIN8N, SPD16N	32 A

A thermo-magnetic switch properly chosen depending on the power cables used can be used instead of fuses.

Installation in compliance with UL Standards

ultra-fast fuses (JFHR2)			
TWIN2N, SPD2N, SPD5N	TWIN5N	SPD8N	TWIN8N, SPD16N
Bussmann FWP10A14F	Bussmann FWP20A14F	Bussmann FWP15A14F	Bussmann FWP32A14F
Ferraz-Shawmut A70P10-1	Ferraz-Shawmut A70P20-1	Ferraz-Shawmut A70P15-1	Ferraz-Shawmut A70P35-4

Use only stranded copper wire rated for 60/75°C.

Use only Listed (ZMVV) or Recognized (ZMVV2) terminal lugs with the appropriate crimping tools.

Resolver cable

The cable must consist of four individually shielded and insulated twisted pairs protected by a shield. The conductor-conductor capacity for the length used cannot exceed 10 nF and the section cannot be less than 0.22 mm². The maximum length is 35 m.

2.4 Ground connections (PE)

It is necessary to minimize the length of the individual cables to be grounded. For this reason we recommend that a grounding bar be placed as close as possible to the frequency converters.

<i>Length (m)</i>	<i>Width (mm)</i>	<i>Thickness (mm)</i>
0.5	20	6
1	40	6
1.5	50	6

The grounding bar must be made of low inductance copper and must be mounted on electrical cabinet back-plat. The table shows the minimum dimensions vs. length.

To connect the converter to the grounding bar use either one cable with a minimum section of 10 mm², or two cables with the same section as power cables.

Use copper grounding cables.

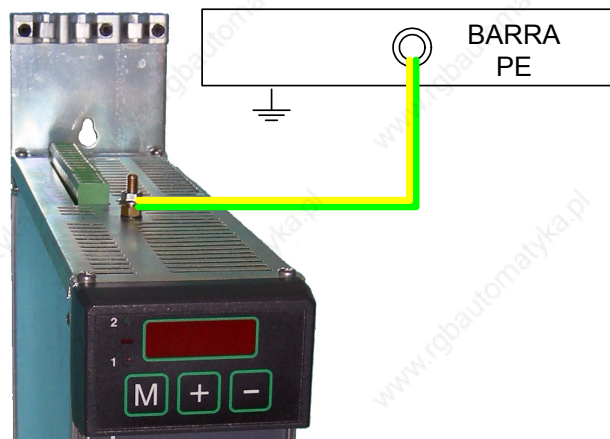

2.5 Line connection diagrams

The converter can be used only in grounded TT and TN industrial networks.
 Suitable for use on a circuit capable of delivering not more than 5kArms symmetrical amperes at maximum voltage 480V +10%.
 Do not use in ungrounded networks (IT), or in networks with asymmetrical grounding.

Connection to AC 3-phase network

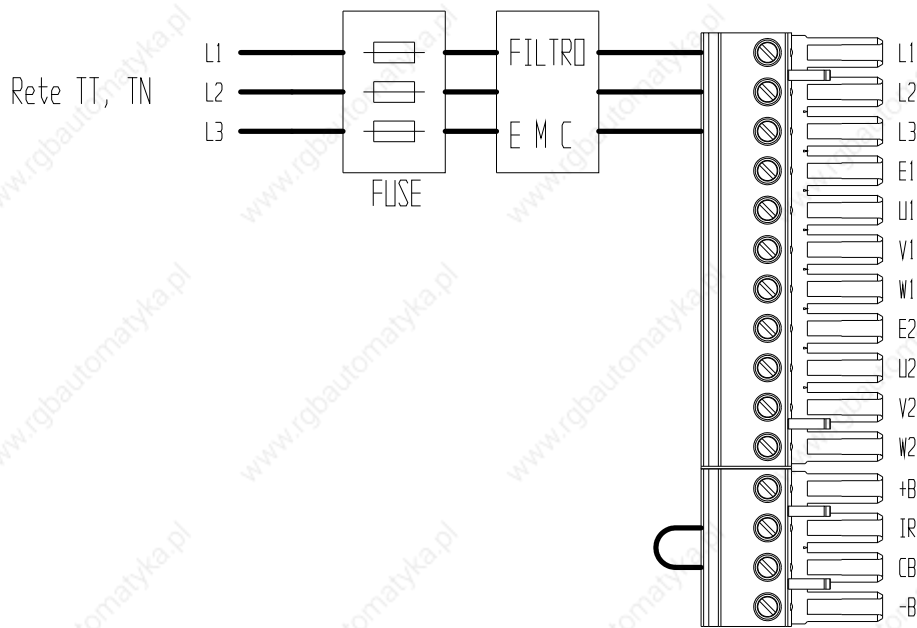

Use of a transformer connected in a star configuration

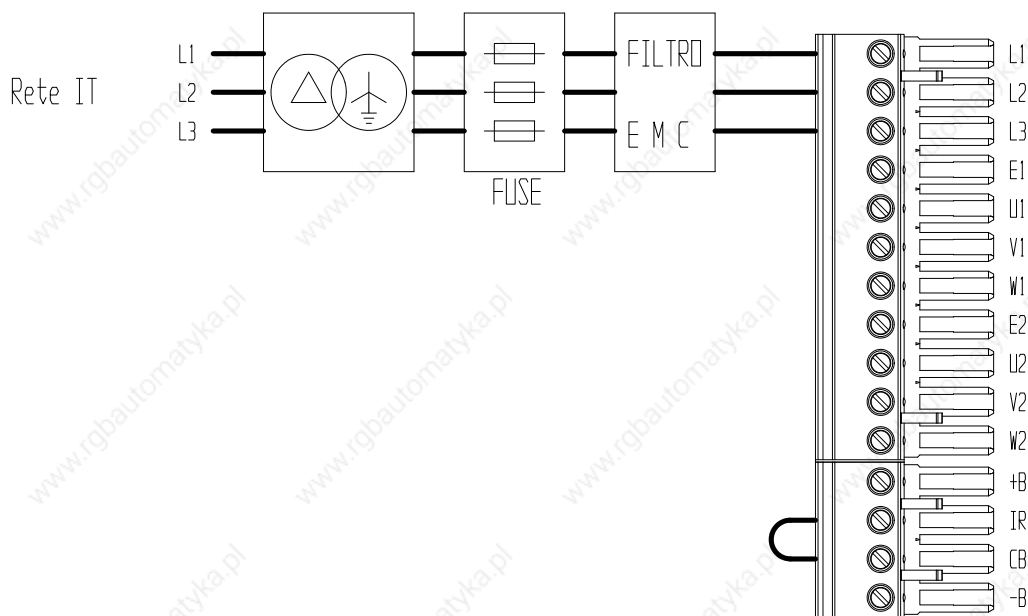

2.6 Motor connection diagrams

MIL motor connector

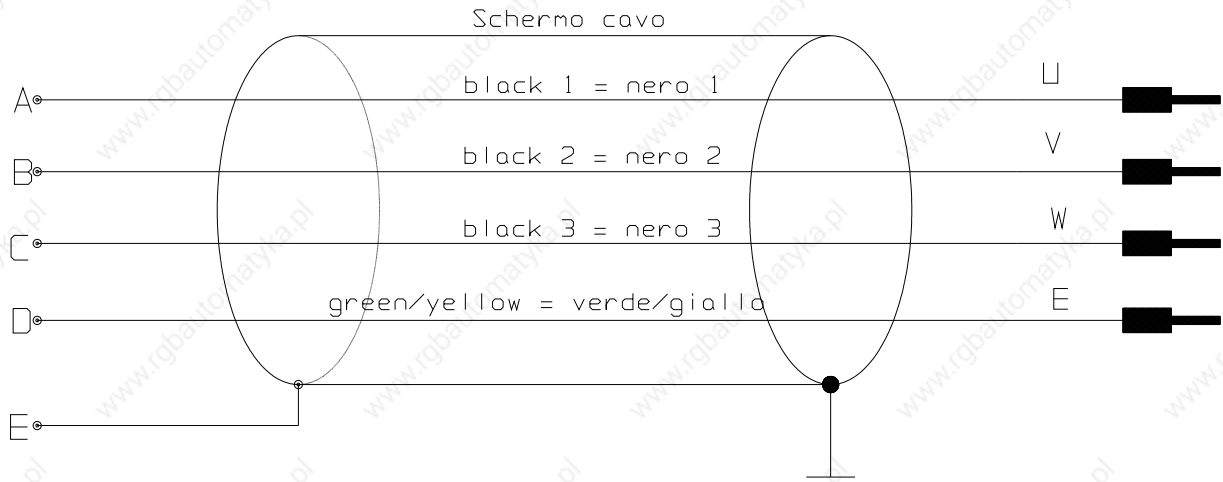

2.7 Resolver connection diagrams

MIL resolver connector

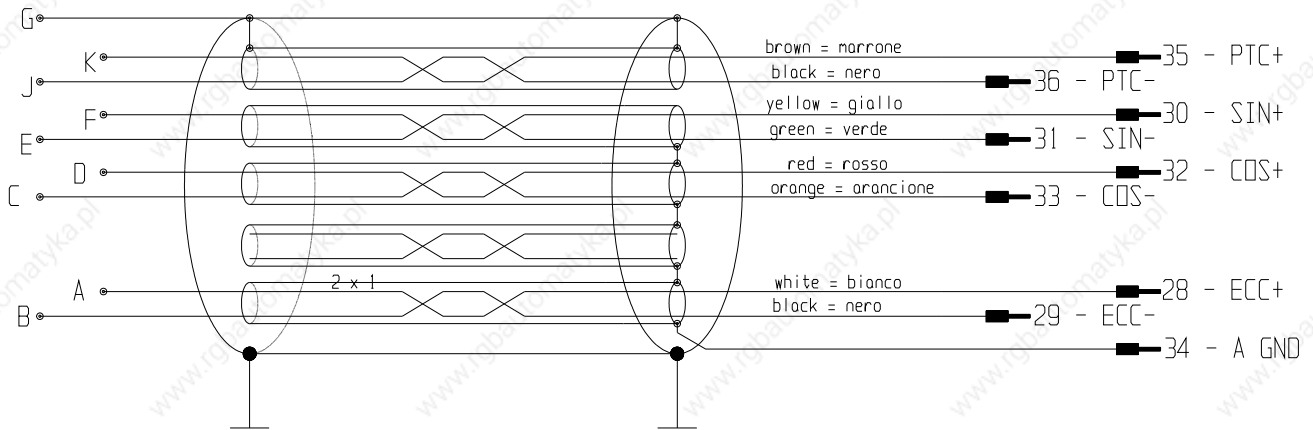

2.8 Signal cables connection

The cable used for the analogue reference must be a shielded twisted pair. The cable used to connect the signals of the simulated encoder must consist of three twisted pairs with a general shield. Shielded cables are also recommended for digital inputs and outputs.

All cables must have a minimum section of 0.22 mm²

2.9 Encoder connection

The line termination resistors must be connected and the value is 180Ω

ENCODER
INCREMENTALE

DRIVE
MORSETTIERA - X4/X5

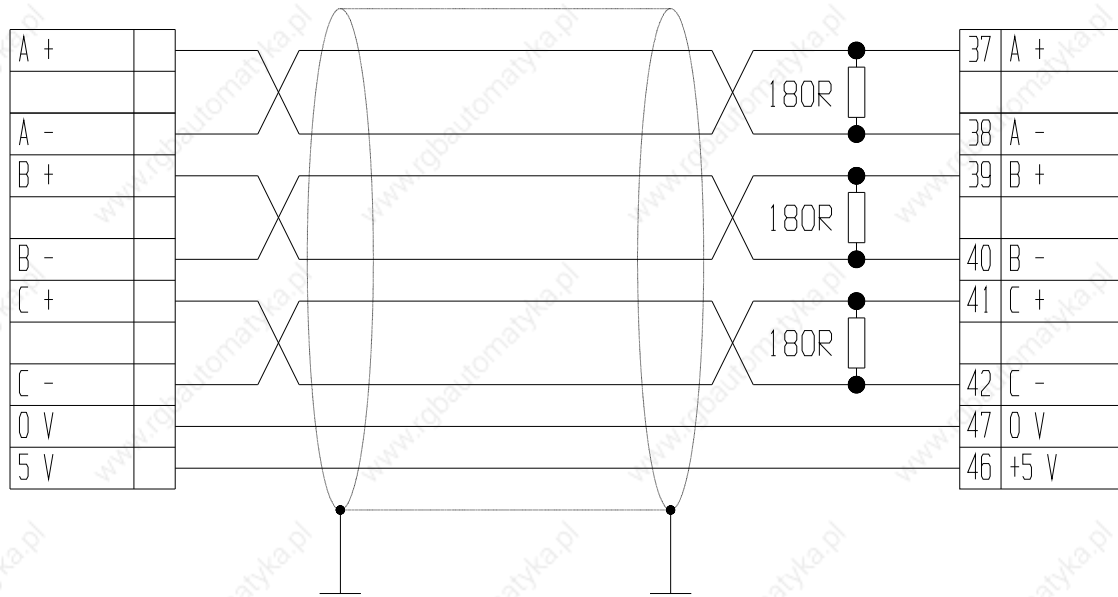

2.11 Encoder sinusoidal + Hiperface connection

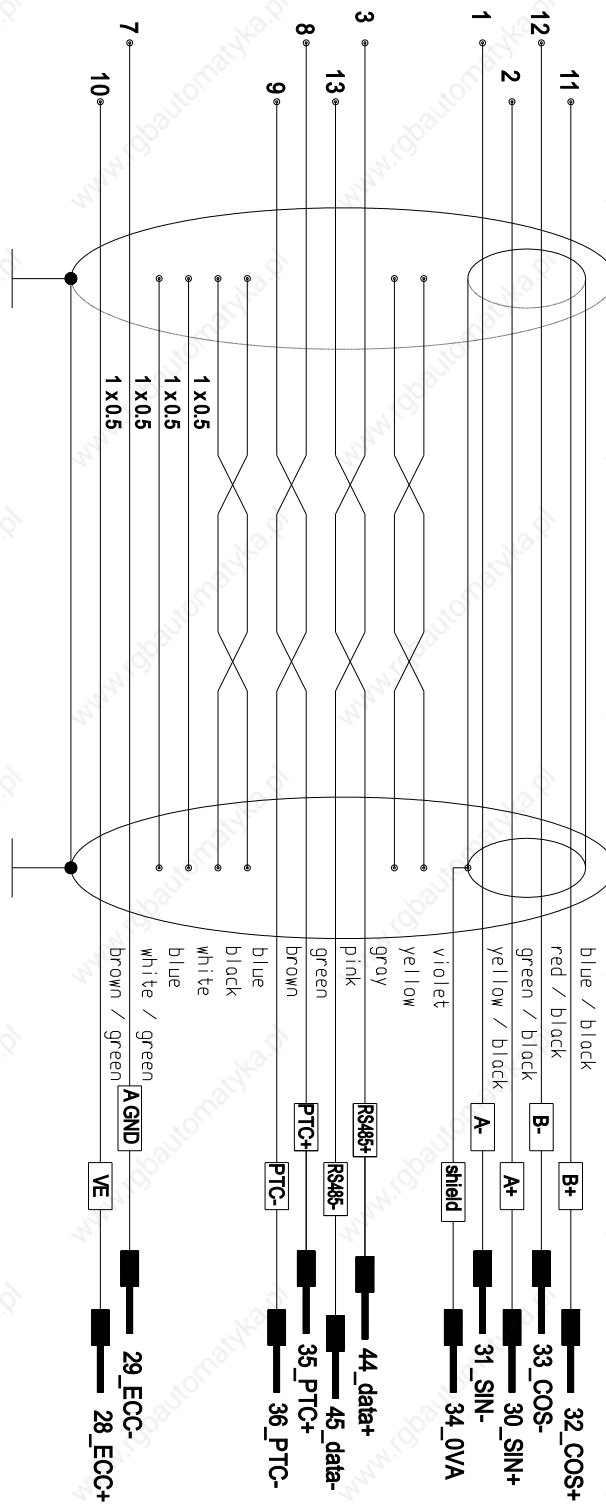

N.B.: the drive requires that the signal Sin+ must be inverted in Sin-, and vice versa; as is showed above.

2.12 Incremental encoder + HALL sensor

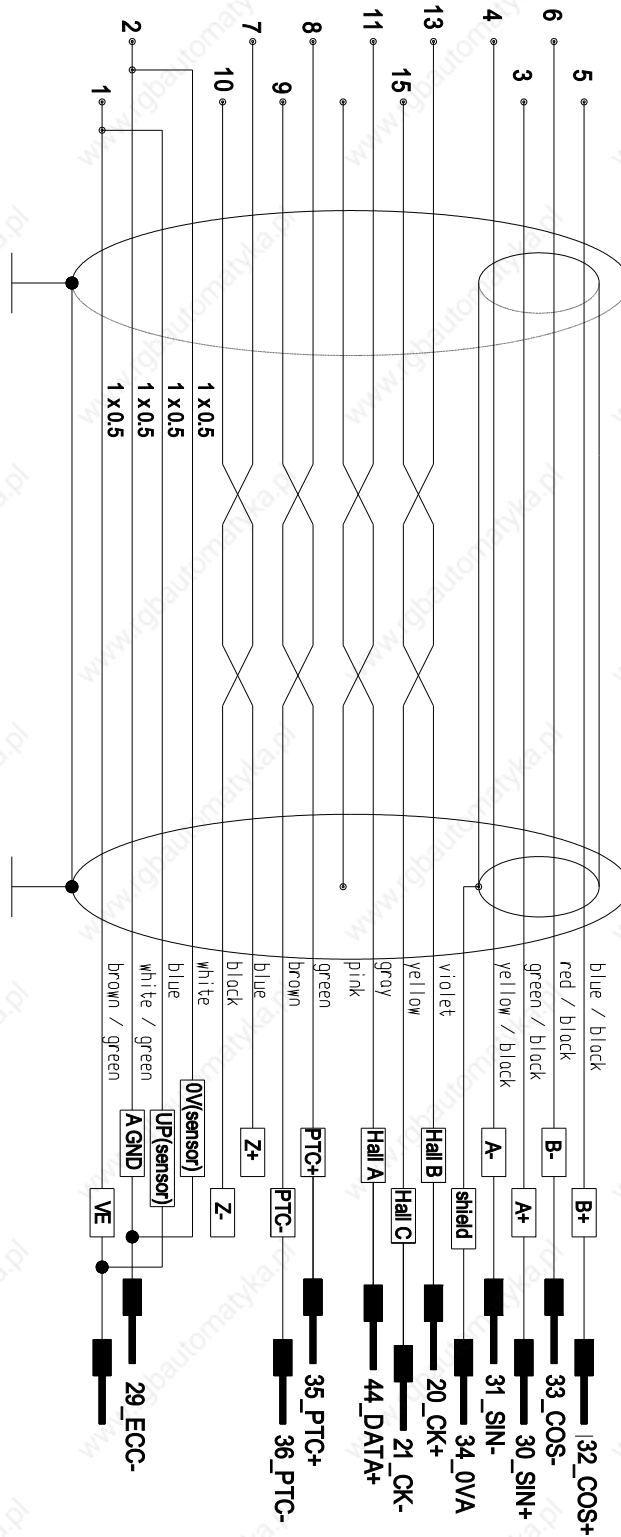

2.13 SinCos (one sin wave per pole pitch)

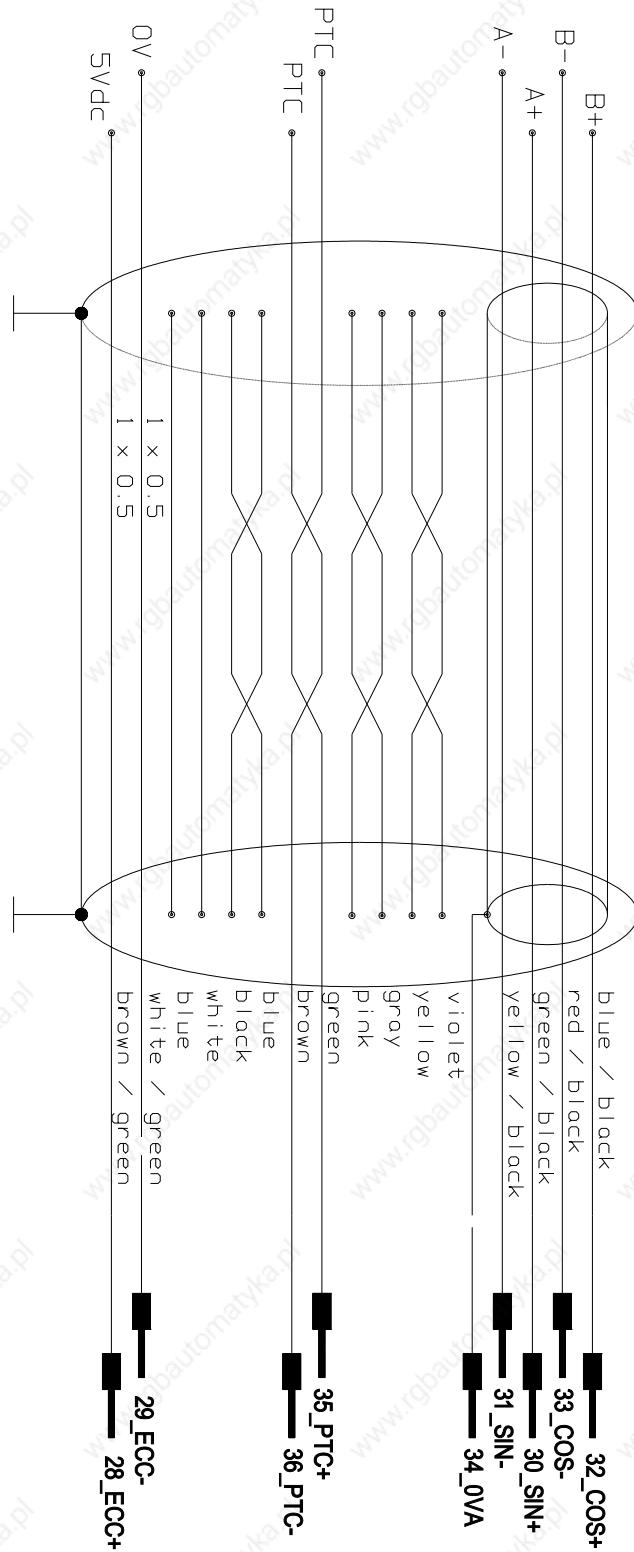

2.14 Frequency input/output connection

The drive has the possibility to “read” two inputs in frequency. The first input Encoder IN type. The input can receive signals in quadrature and frequency/sign, (b42.5), from an incremental encoder to 5 Volt-DC as from standard LineDrive-RS422. Follow the outline of connection for the reference of frequency, whether from an encoder or from an external module:

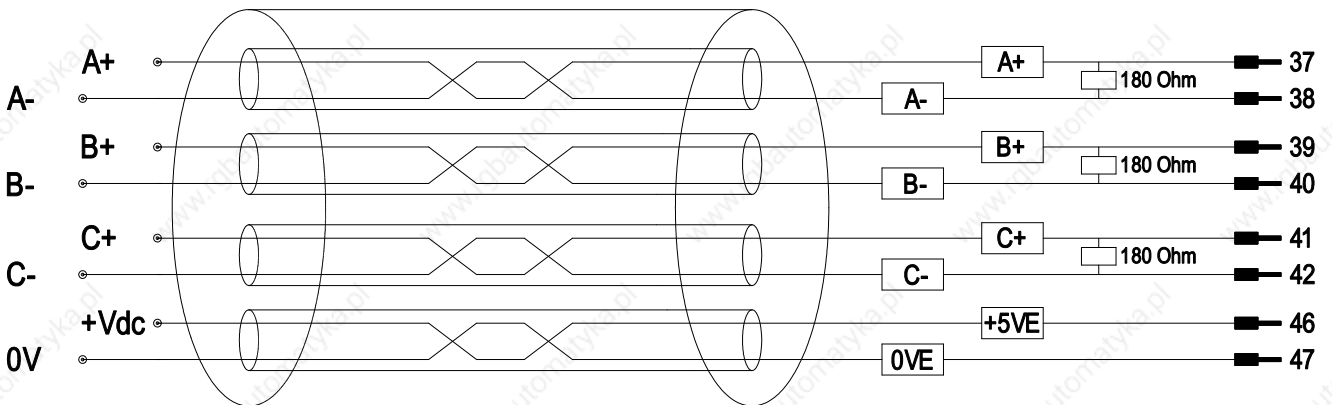

The second input in frequency uses two digital inputs. The input can receive signals in quadrature and frequency/sign, (b42.4), from IN2 and IN3 digital inputs to 24 Volt-DC. Follow the outline of connection:

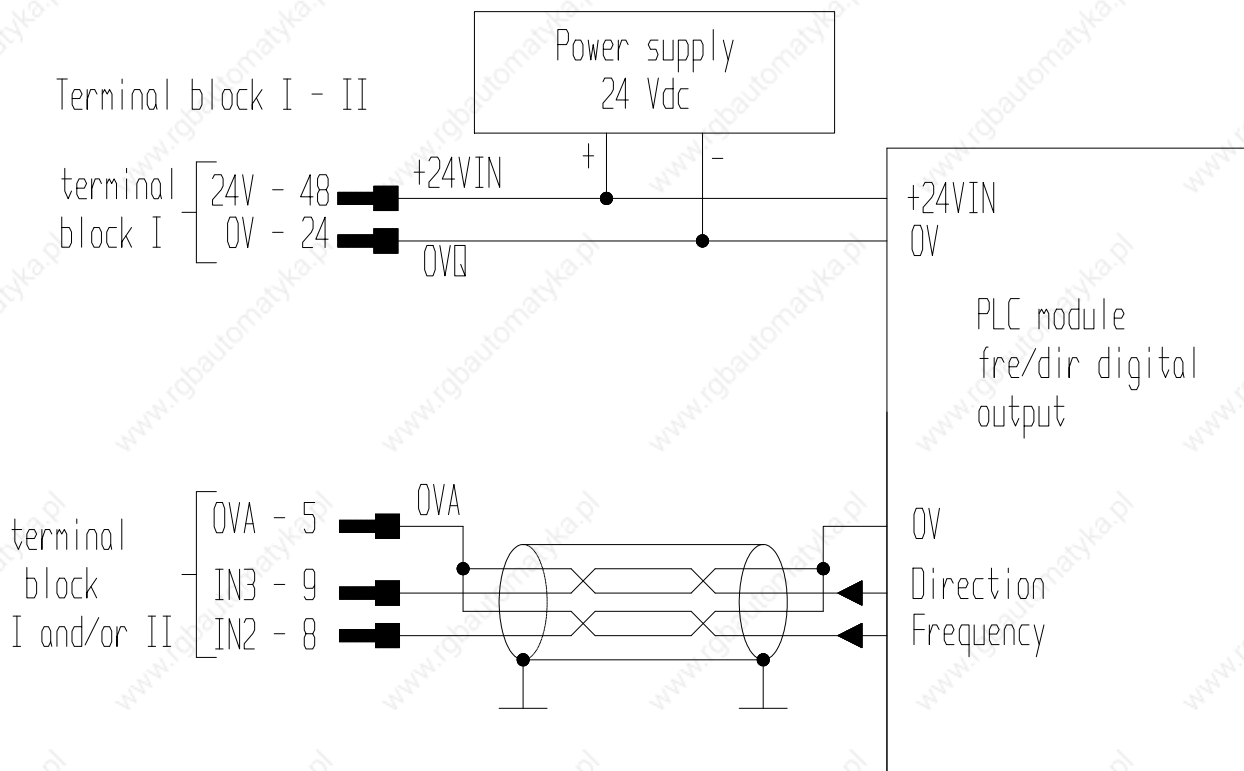

2.14.1 Connecting the drive to the digital-lock

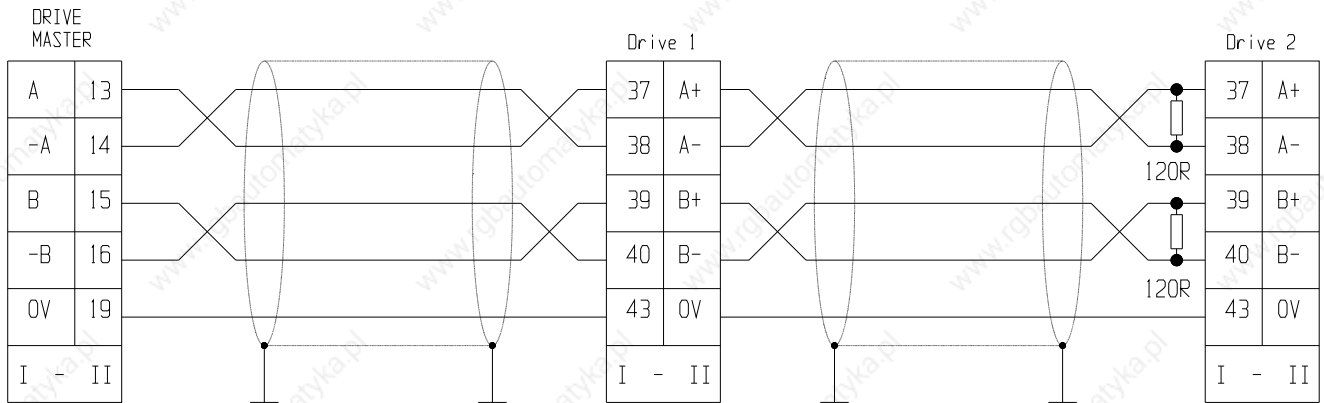

In the example given above, the connection of two drives to the Digital-Lock with a master is shown, but the diagram could be extended to several converters respecting the series connection. The line charge resistors must be connected to the last converter. The master can be an encoder powered externally or an encoder simulator of another converter.

The signal of the master encoder must in any case be of differential type 5V RS-422.

You can connect up to 32 converters to the electrical shaft by using the same signal of the simulated encoder (standard RS-422).

Alternative at the reference in frequency it's possible to execute a connection in digital lock by the digital CAN bus on X2 connector. Follow the outline:

encoder CAN

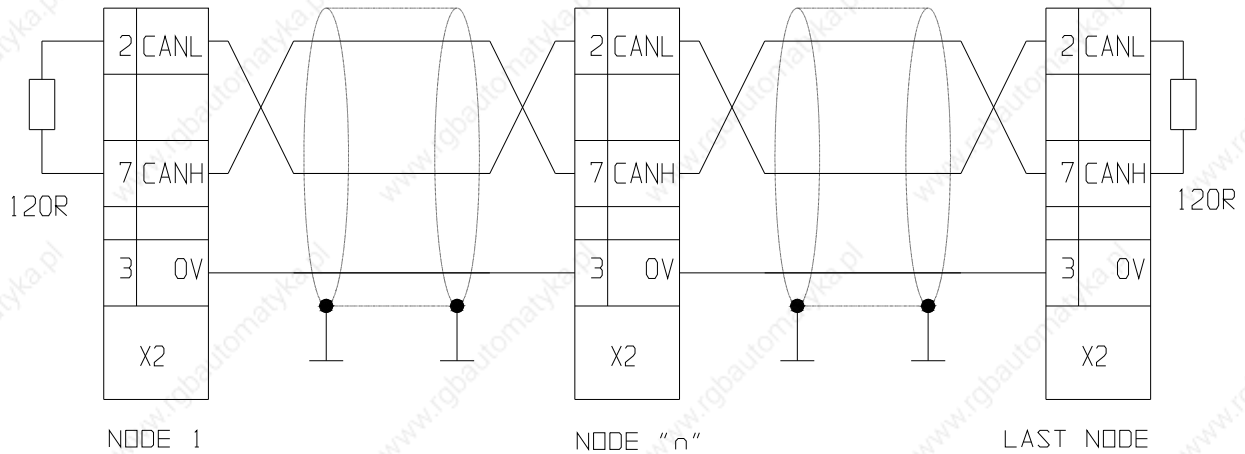

See par. "Digital Lock + Positioner" about the programming.

2.15 Serial line connection

The serial line of the drive can be configured as either RS-422 or as RS-485 depending on how the connection is made. Realize the ending only on the last node, like shown in the following. For the pin, see "Signal connectors layout".

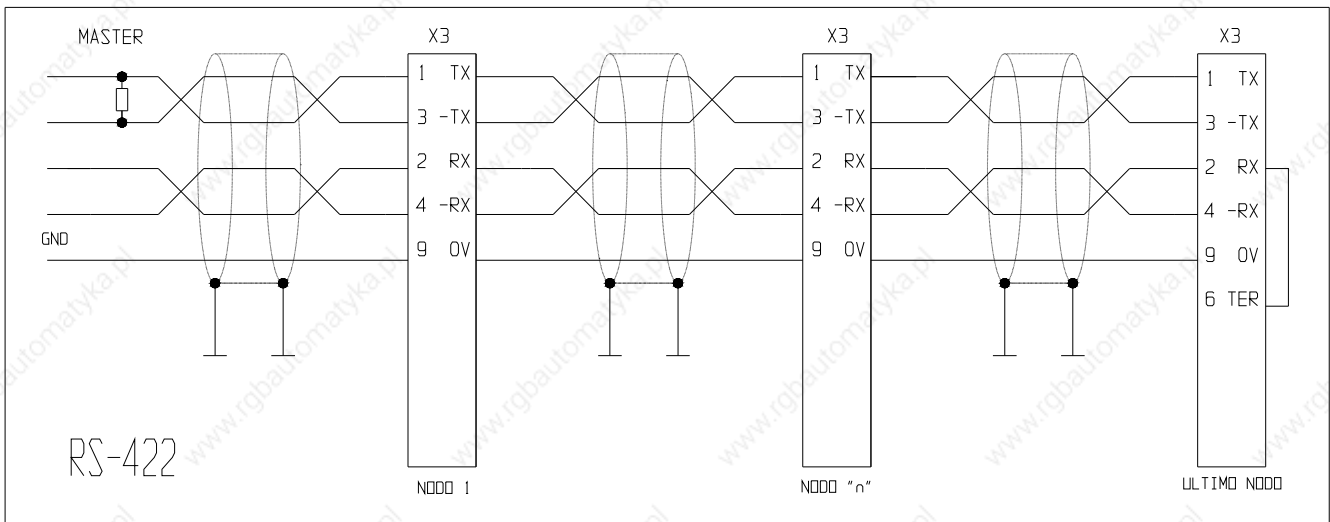
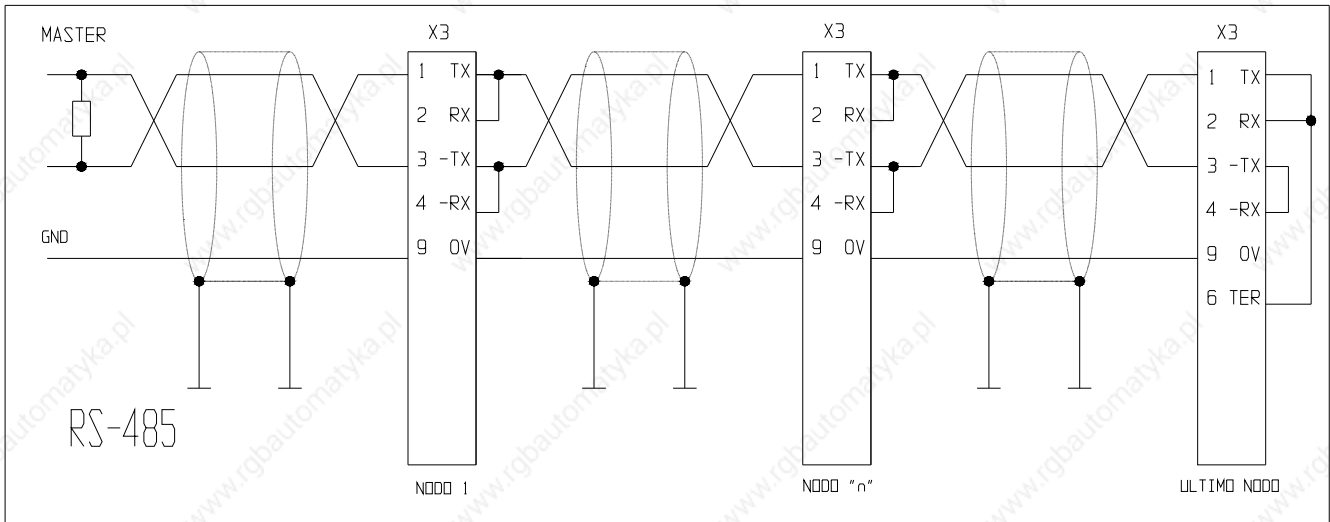

2.16 CAN line connection

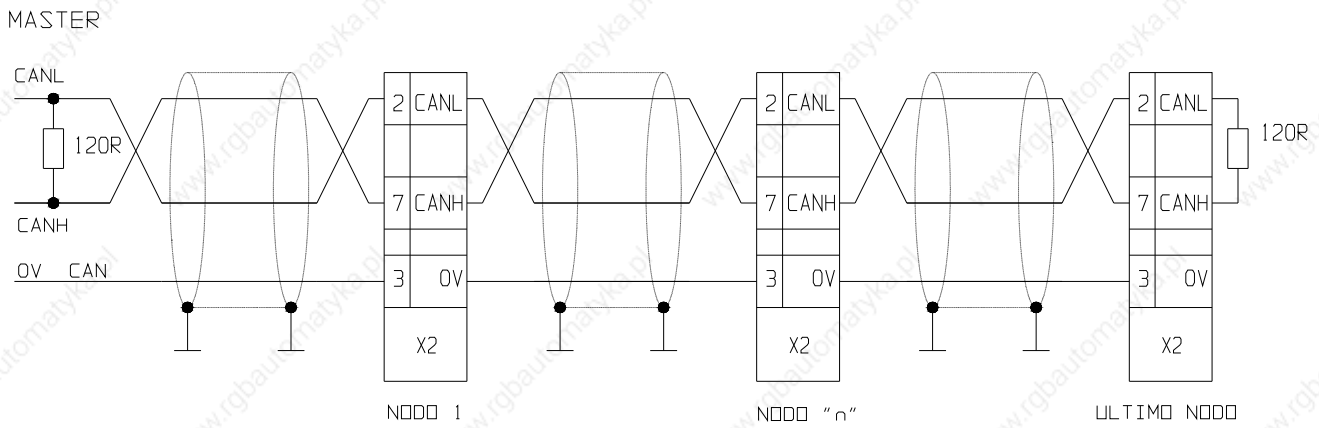

There is a CAN-bus interface on the drive, type Physical layer ISO/DIS11898, the DATA link is full CAN version 2.0 part A (ID 11 bit), and a subset used for application layer SBC CAN. Realize the ending only on the last node, like shown in the following

2.17 External +24V power supply for the control stage

The drive electronics, must be supplied with an external 24Vdc power supply (pins: 24 and 48 of terminal block I).

The 24Vdc power supply must be exclusively dedicated to the drive. Sharing the power supply with other devices (e.g. brakes, electro-valves, etc.) could cause malfunctions.

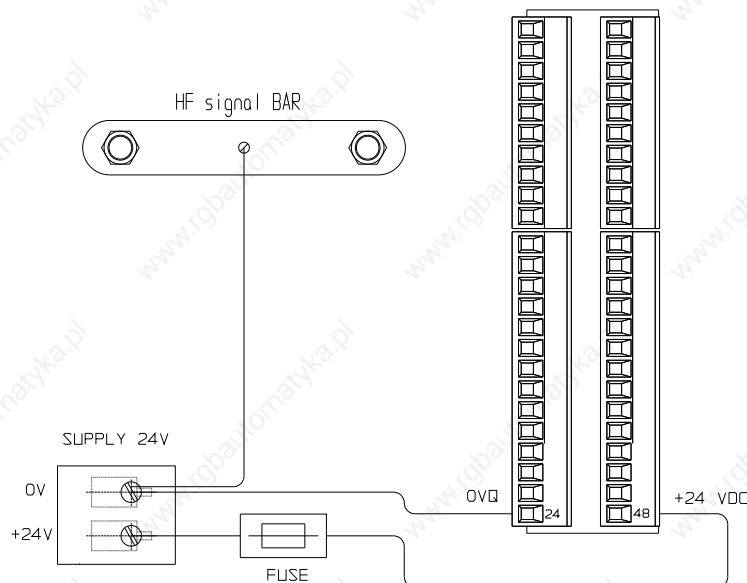

Use a Class 2 or a Low Voltage Limited Energy external power supply, protected with 3,15A rated fuse.

2.18 External braking resistance

The drive has an internal braking resistance. When a higher braking power is needed, it is possible to connect an external braking resistance to the drive.

The external braking resistance value must be **40 Ohm** and it is necessary to place a magneto-thermal switch (or a fuse) between the external braking resistance and the drive.

The minimum cross section of the conductors depends on the drive size and it is equal to the minimum cross section of the conductors between motor and drive (see paragraph "Power connections"). It is necessary to minimize the connection cable length. In any case the cable length must be less than 3 m.

The connection of the external braking resistance is shown in the following pictures. The bridge between IR and CB terminals (see pictures) enables the internal braking resistance; when the external braking resistance is connected, the IR-CB bridge must be removed. Connect the external resistance to the pins: +BUS and CB.

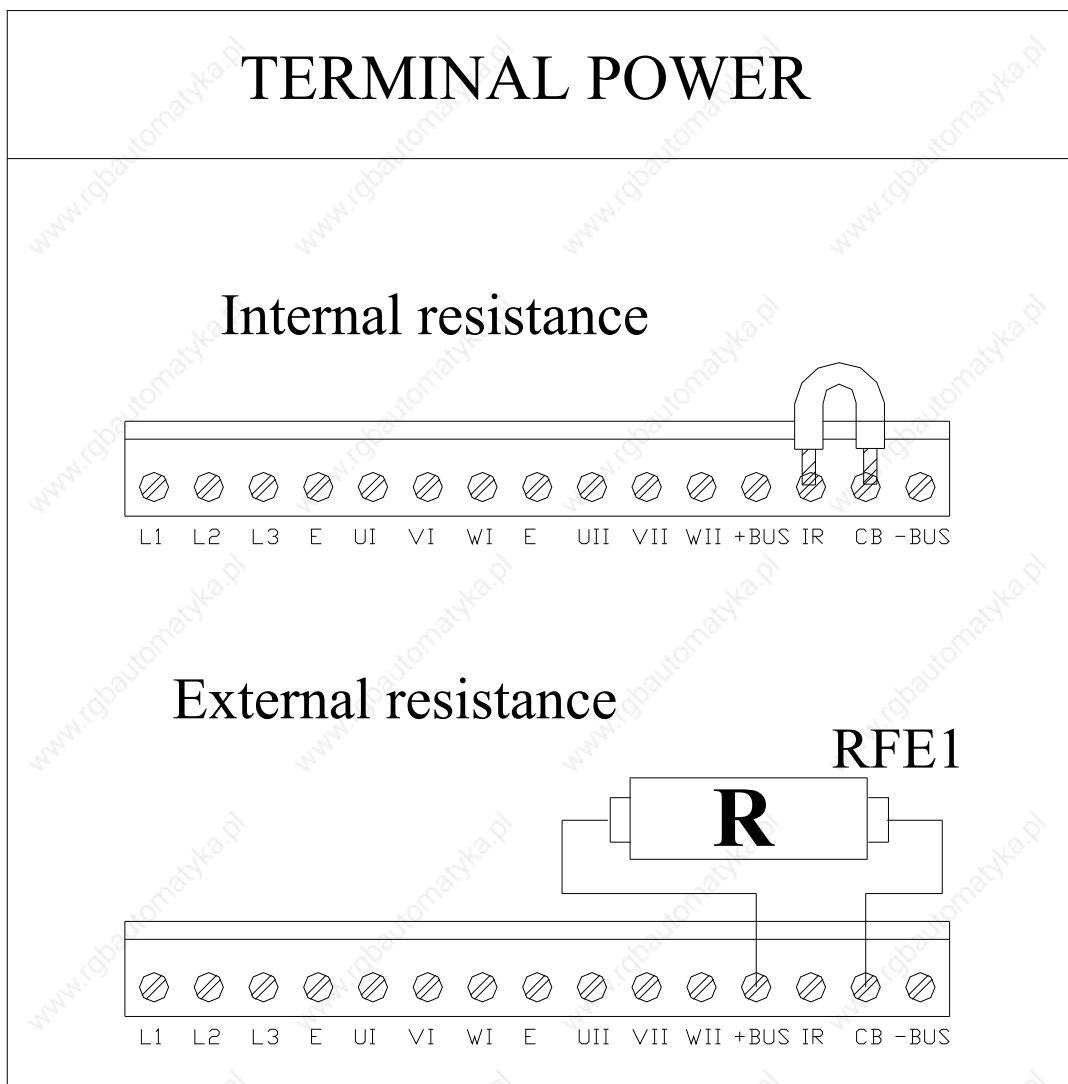

3 Using the keyboard

The keyboard-display module is easy to use. It is used to program the functional data, control the status of the converter and send commands. It consists of only three keys located directly beneath the display. The keys are marked: [M], [+], [-]. The [M] key is use to modify the display and consequently the function of the [+] e [-] keys.

There are two types of display: parameter mode and parameter value mode.

When the converter is powered on, if there is no alarm, the user sees 'IDLE' or 'RUN' on the screen, depending on whether the converter is on or off. This is also the position of the Pr0 parameter.

To view all the parameters, press the [+] o [-] keys. If you want to verify the value, press the [M] key. When the value is displayed, it can be modified by using the [+] e [-] keys. To return to parameter mode, press the [M] key again.

The type of display depends on the type of parameter displayed.

If you need to increment or decrement quickly the value of a parameter, you can do this by pressing the [M] key while the increment [+] key or decrement [-] key is held down.

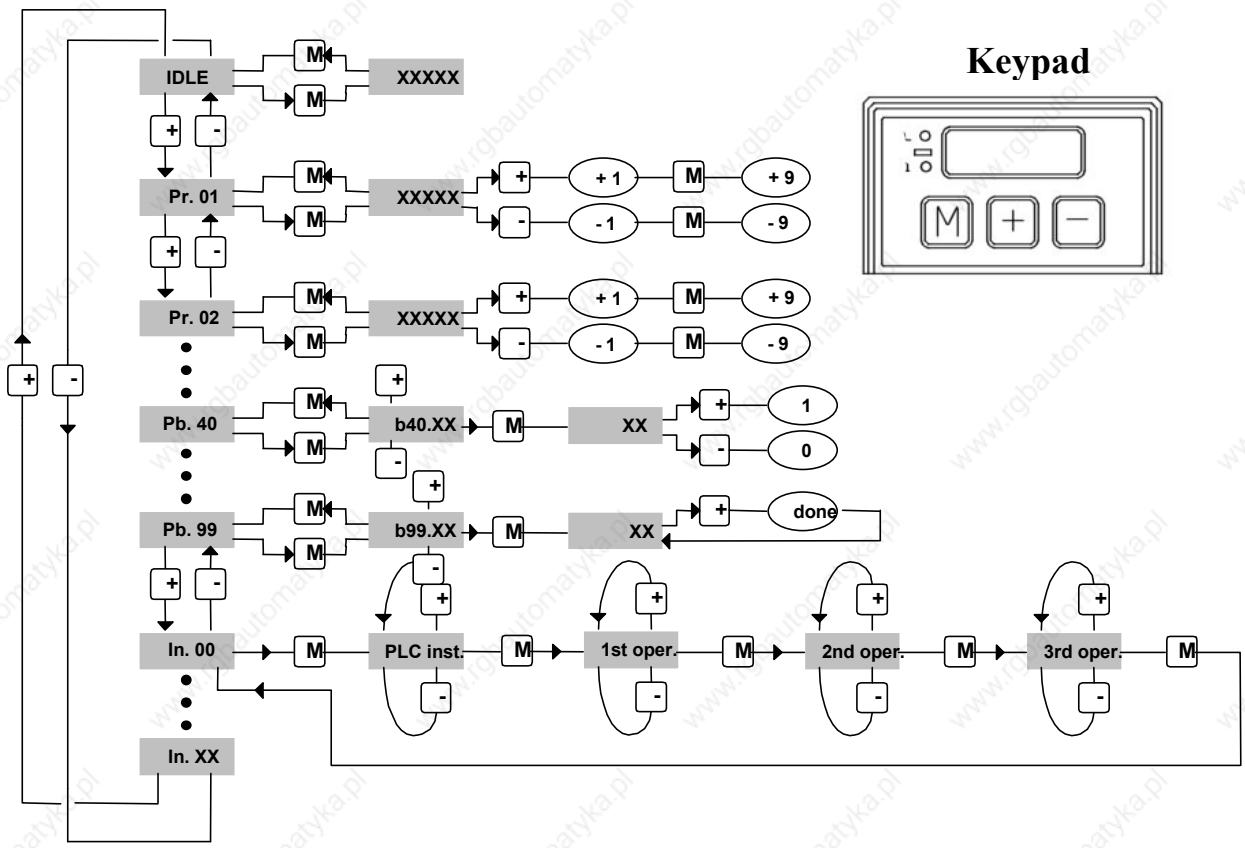

Hold M pressed for 2 sec. while the name of a parameter (PRxx) is displayed to make the keypad control switch to a different axis; a led will denote the active axis.

The following messages may be displayed on the screen, in addition to the value of the parameters and the instructions of the pico-PLC:

r. xx	When the converter is powered on, this message indicates which version of the software is installed.
IdLE	When the converter is powered on and corresponding to Pr0, this message indicates that there is no alarm and that the converter is off.
run	When the converter is powered on and corresponding to Pr0, this message indicates that there is no alarm and that the converter is on. The motor shaft may be rotating.
Er. Xx	Corresponding to Pr0, this message indicates that the converter has registered an alarm (xx indicates the alarm code) and has shut off. When it registers an alarm, the converter is brought to Pr0, displaying the alarm code.
Pr. Xx	Indicates the parameter xx whose value can be displayed by pressing the [M] key.
Pb. Xx	Indicates the parameter at bit xx.
bxx.yy	Indicates the bit yy of parameter xx. By pressing the [M] key, the status of the bit is displayed.
Hxx.yy	Indicates bit yy of parameter 1xx. By pressing the [M] key, the status of the bit is displayed.
In. xx	Indicates instruction xx of the PLC program.
donE	Is displayed for about 1 second whenever a command is sent.
rESet	Is displayed for about 1 second whenever an alarm reset command is sent (b99.10).
dEF	Indicates that the drive is set to default status and must be programmed with the basic parameters of the motor.
triP.x	Indicates that the converter has malfunctioned.

If you cannot modify the read-write parameters using the keypad, be sure that b99.7 is 0; if it was 0, probably the same parameters were modified by the pico-PLC program.

4 POWER SUPPLY MODE

4.1 "Low" voltage power supply

This procedure is for those situations in which the operator needs to work in close proximity to the machine in a situation which could be potentially hazardous. In these conditions, the operator must move the axes with a drive power supply voltage lower than the nominal rating (from 40 to 180V~, and from 57 to 255 VDC), so that the maximum allowable speed of the axes is also lowered.

This mode is enabled by b40.10=1. The motor is actually enabled approx.120ms after closing the contact that overrides the holding charge resistance. This contact is activated when the internal continuous voltage in the drive gets over 40VDC, provided that there aren't any active alarms and that hardware and software enabling commands are available.

In the same way, an under voltage alarm is generated when the voltage level falls below 40VDC.

The undervoltage fault automatic reset command is not active in this mode and b39.3 and b39.4 have no significance.

Caution:



the switch between low voltage and high voltage modes is potentially dangerous to the drive. Always switch between modes with the drive disabled and follow these instructions step by step.

- Low voltage to nominal operating voltage sequence.
 - a. Disable the drive. Wait 200ms.
 - b. Change the voltage from low to nominal.
 - c. Set bit b40.10 to 0
 - d. Wait 200ms.
 - e. Enable the drive. The drive will be enabled after about 120ms.
- Nominal operating voltage to low voltage sequence.
 - a. Disable the drive. Wait 200ms.
 - b. Set bit b40.10 to 1
 - c. Change the voltage from nominal to low.
 - d. Wait 200ms.
 - e. Enable the drive. The drive will be enabled after about 120ms.

4.2 “High” voltage power supply

In “high ” voltage operating mode (b40.0=0), the converter can be supplied as follows:

- AC 3-phase network (200...480 ±10%)
Set b39.0=0 (default).
The converter can automatically detect the power supply voltage rating and adapts internal operating parameters accordingly. When one of the power supply phases is missing, b39.4=1.
- AC 1-phase network (200...277 ±10%)
Set b39.0=1 and set the peak nominal value of 1-phase supply ($\sqrt{2} \cdot V_{\text{phase-neutral}}$) in Pr206 . Save, switch off and on again the converter.

With both modes of AC power supply, when parameter b39.3=0 the input power supply is on. In case of power loss the bit is set to one, anticipating the converter's “under voltage” alarm that is based on continuous voltage.

- Continuous (288...678 ±10%)
Set b39.0=1 and set the nominal value of continuous voltage in Pr206. Save, switch off and on again the converter.

In AC 1-phase or Continuous supply, it's possible to limit the maximum output voltage of the drive with the bit b39.1=1 and setting the threshold of the “over voltage” alarm in Pr207.

The automatic reset of “under voltage” undervoltage alarm can be forced by b99.8=1 with any kind of power supply.

5 START-UP

In Its basic configuration the drive can control both synchronous permanent magnet motors (brushless) and asynchronous induction motors, with feedback. The setting of Pr217 can select either of the following:

- Pr217=0 **synchronous motor** (default setting).
 Pr217=1 **asynchronous motor**.

The drive is supplied with default factory parameter settings. See the following chapters for use and start-up.

5.1 Setting the default parameters

If you want to set the default values of the converter as it was supplied by the manufacturer, do the following

- power off the converter using the hardware (pin 6 of I and II axis)
- connect only 24Vdc
- power on the drive
- set b99.7 and b99.13 to 0
- issue the command b99.12
- save the set up using commands b99.14 and b99.15.

5.2 Selection of motor type

The first time the converter is powered up, or following a default command, the drive indicates a "dEF" condition (alarm Pr23=15).

In order to leave the drive's initial condition, the operator shall have to input the motor data.

The parameters defining motor types are as follows:

Pr29	Number of motor poles		N.
Pr32	Rated speed of the motor		r.p.m.
Pr33	rated motor current (ex. 2.5A, write 2.5)	A	
Pr34	number of resolver poles		N.
Pr46	phase-phase motor resistance (ex. 1,8Ω, write 1.8)		ohm
Pr47	phase-phase motor inductance (ex. 2.6mH, write 2.6)		mH

With asynchronous motors, the values above shall be supplemented with the following parameters:

Pr217 = 1			} <u>Solo per motore asincrono</u>
Pr218	base speed	r.p.m.	
Pr219	slip	r.p.m.	
Pr220	magnetizing current (*)	A	

After setting the parameters that fit the motor, the operator must give the save data command, b99.15. The drive will calculate the correct values of Pr2, Pr3, Pr16, Pr17, Pr18, and Pr19 and save the parameters. At this point the basic parameters cannot be modified. If you want to modify one of them, you must enter b94.3=1. The “dEF” alarm will be displayed again and after updating the value of the parameter, it must be saved by entering b99.15 again.

(*) With configuration tool: *MotionWiz*, to set the data plate in the *custom* motor table, because MotionWiz uses these data to calculate the magnetizing current.

5.3 Changing motor data

After having entered a data save command, no other changes shall be made to the motor parameters. In order to change the entered parameter values (new motor), enter command **b94.3**. The drive shall return to its default condition and changing motor data shall be enabled again. Repeat the data save procedure with command **b99.15** (with drive disabled) if you want to recalculate parameters Pr2, Pr3, Pr16, Pr17, Pr18 and Pr19 with the new motor data.

5.4 Setting feedback

The drive can use various types of sensor for the control of the speed and current loop. The choice of the type of drive must be made in phase of order, because there are two configuration type of the drive. The type of feedback for TWIN-N is equal for each axis.

5.4.1 Feedback configuration

The following table reassumes all the possible configurations and indicates the relative formulation of the parameters:

<i>Type motor feedback</i>	<i>configuration</i>				<i>N. of pulses revolution</i>	<i>Supply</i>	<i>Drive code</i>	
	b42.9	b42.8	b42.7	b42.6				
Resolver	0	0	0	0	-	+ECC, -ECC	SPD-N TWIN-N	
Encoder	0	0	0	1	Pr196	+ECC, -ECC set the power supply (b231.6 e b231.7)	SPD-NE TWIN-NE	
Encoder less wiring	0	0	1	0	Pr196			
Encoder sinusoidal + Endat	0	0	1	1	Pr196 (only read)			
Encoder sinusoidal + Hiperface	0	1	1	1	Pr196 (only read)			
Encoder sinusoidal	0	1	0	0	Pr196			
SinCos One sin wave per pole pitch	1	0	0	0	Pr196			SPD-NF TWIN-NF
Inc. encoder + Hall sensor	1	0	1	0	Pr196			SPD-NH TWIN-NH
auxiliary incremental encoder	1	1	0	1	Pr196	+ 5VE, 0VE	(every available)	

This selection configures the feedback of the speed control and of current and in the configuration of default it is used also in the position control.

After to have saved the configuration the activation of the selected feedback happens to the successive start-up of the drive.

5.4.2 Select supply feedback

The supply of feedback is between -ECC and +ECC pins.

With resolver feedback, the drive has a sinusoidal supply to 8kHz with short circuit and overload protection, the value of voltage is 8V peak-peak.

With encoder feedback, the drive has a variable supply and the user must be set this value respecting the electric characteristics of the device, following this table:

	Supply voltage +ECC, -ECC			
	5 [Vdc]	5,5 [Vdc]	8,1 [Vdc]	8,6 [Vdc]
b231.6	0	1	0	1
b231.7	0	0	1	1
max current	250mA for each axis with short circuit protection			

The selection of power input voltage is only performed at the drive's start up. In order to enable the selected voltage, save the parameters, then switch off and on again the drive. The feedback must be connect after the correct programming.
Attention: the configuration of the feedback is realized only on I axis for both axes.

5.5 Feedback from SinCos encoder or SinCsos + Endat encoder

This type of feedback must be expressly requested when placing your order. Because the hardware of the drive must be modify and in this configuration the drive can't use other type of feedback.
If the order hasn't the feedback requested, the configuration of the drive is standard: the resolver is typology of the feedback.
About the connection draw, see the paragraph "Hedenhain Encoder connection".

When the feedback is SinCos or SinCos +Endat see par. "*setting feedback*". Pr196 is updated in automatic, if it is present the Endat interface, to the values made from read the Eeprom inside to the encoder.

Save the data (b99.15), turn off the drive and turn on again for activate the new formulation.

The user must not use Pr159-Pr160 (reserved)

The procedure of the phasing is the same for incremental encoder (see paragraph "*encoder phasing*").

If the Endat interface, single turn or multiturn, after the phasing is possible to save this information so at every start up the phasing procedure isn't necessary; for take it, to bring the motor shaft in the position that Pr28=0, disable the drive and save with command b99.9=1.

After this command is necessary start again the drive.

Alternative to this procedure, when Endat interface, disconnect and disable the drive, is available to supply a positive tension between phase B and C respect the phase A so that the shaft aligned, set the command b99.9=1 and start again the drive.

In the case of an encoder with EnDat single turn at power up, Pr62:63 = Pr28, that is the absolute revolution position. With a multiturn encoder, initialize the absolute position read at power up in Pr2:63 by following the procedure below:

- bring the axis on the desired mechanical position
- set an operating mode in the drive that uses the position loop (Pr31=13 or 14);
- enable the operating mode when bit b40.2=1;
- disable drive hardware when b41.5=0;
- set the desired position in Pr64:65;
- enter command b94.14=1 to complete the phasing;
- switch off and on again.

When the unit is powered on, Pr62:63 shows the desired position on the absolute multiturn. Such absolute position has a range of $\pm 2^{23}$.

IMPORTANT: after set one of the above mentioned command (b94.14 and b99.9 with drive disabled) the flag b41.6, encoder ok; set to 0, the drive needs to restart for to permit new enable of the axe.

5.6 Feedback from incremental encoder

In place of the resolver it is possible to use an incremental encoder (must be expressly requested when placing your order). When the feedback is incremental encoder see par. “*setting feedback*”. Modifications at this bit are available only after restarting of the drive.

The phasing procedure must be run upon every drive start up.

It's possible choose among two type of procedure, and it's necessary that the motor must be free to rotate, also when the motor is mounted into the system (the brake of the motor must be disable). During the phasing procedure 1, the drive checks the connections, and the movement of the motor is broadest, so this procedure is recommended for the first time.

5.7 Encoder phasing

5.7.1 Type 1 phasing

b94.2 actives this procedure. The parameters are shown in the table below:

Par.	Description	Field/Unit	Def.	Type/Notes
Pr196	To insert number of the step to turn encoder	±32767	1024	R/W M
b94.2	Command phasing 1. It's necessary to disable the software (b40.9=0); enable the hardware (b41.5=1), and driver OK (Pr23=0). The motor executes two movements and the last is about 90° degree electric, with control sign of the encoder feedback. Introduce the correct number of the motor poles (Pr29).		0	
Pr89	Status: 0 if positive result 2 if wrong enabling 3 if positive feedback 4 if wrong motor poles (tolerance ±22.5 electric degrees) 5 if drive not ready (Pr23 ≠0 or open inrush)			R
b41.6	Phasing result :=1 if positive result of the procedure and necessary condition for drive OK (b41.4)		0	R

5.7.2 Type 2 phasing

b94.4 activates this procedure. The parameters are shown in the table below:

Par.	Description	Field/Unit	Def	Type/Notes
Pr196	To insert number of the step to turn encoder	±32767	1024	R/W M
b94.4	Command phasing 2. It's necessary to disable the software (b40.9=0); enable the hardware (b41.5=1), and driver OK (Pr23=0). The motor executes a vibration, the standing depends to the type of the motor and to the load.		0	
Pr89	Status: 0 if positive result 2 if wrong enabling 5 if drive not ready (Pr23 ≠0 or open inrush) 6 Pr201 parameter calculated (frequency of vibration) is different of 25 unit from starting value 7 Pr201 parameter calculated (frequency of vibration) exceeds 200 unit (max. value)			R
b41.6	Phasing result =1 if positive result of the procedure and necessary condition for drive OK (b41.4)		0	R

The calculated value of Pr201 at the end of the procedure, if it is save, it permits at the new start-up that the procedure starts from this value, and if the mechanical conditions don't change, is maked only one vibration of standing fixed by Pr201.

N.B.: (*) *during the phasing procedure the motor must be motionless, so if the motor is on vertical axe, this system must be motionless without to use the brake.*

(**) *the encoder simulation can't use zero encoder track as reference for reset the machine, when the system uses a axis control and the FBK is a incremental encoder.*

5.8 First commissioning

The steps to be followed carefully the first time the converter is used are given below.

- 1) supply the drive with only 24V and insert the motor and feedback data, save (b99.15) and put off the device.
- 2) Connect the motor to the converter by following carefully the diagrams in the manual.
- 3) Disable the drive (pin 6 of terminal block).
- 4) Power the converter on.
- 5) The "IdLE" message will appear on the screen.
- 6) Set the analogue reference to 0 V (pin 25, 26 of the terminal block) and power the converter on (24 V at pin 6 of the terminal block).
- 7) At this point the motor shaft should be stopped. Any change in the voltage of the analogue reference should produce a proportional change in the speed of the motor. If this does not happen, control the cabling.

The enable bit of the drive (b41.5) can be set by a digital input used from pico-PLC, or via serial line or CAN bus.

The converter comes with default values pre-defined that satisfy most applications. In the default status the pico-PLC in the converter runs the program (described in *Appendix*) and the following functions will be set at the input/output connectors:

PIN	INPUTS
6	Converter on (24V – on)
7	stop / start (24V - stop)

PIN	OUTPUTS
11	drive ok (24V - ok)
12	Motor Overloaded (i^2t)

5.9 Speed control adjustment

SOME IMPORTANT CONCEPTS

SPEED LOOP: The main task of a converter is to control motor speed so that it follows as faithfully as possible the speed request that is generally known as the REFERENCE.

Faithfully following the reference means that the motor speed should equal the reference in static conditions and also that the motor speed is as equal as possible to the speed requested during dynamic conditions. To carry out this task, the converter must know some of the features of the motor used and the mechanical part attached to it. This information is communicated to the converter by using the so-called ADJUSTMENT PARAMETERS.

ERROR: The error is the difference between the reference speed and the motor speed. The size of the error is used by the speed loop in order to evaluate how much current must be supplied to the motor, based on the adjustment parameters.

TORQUE: The current that circulates in the windings of the motor is transformed in torque, thereby allowing the motor to accelerate or decelerate.

GAIN: Given the typical applications of the converter, when we speak of gain in this document we refer to the rigidity of the axis, better known as the STIFFNESS.

To better illustrate what stiffness means, we can imagine a motor controlled by a converter with a requested speed of 0. The motor shaft will appear immobile, but if we apply a torque to the shaft, it will demonstrate an angle that is proportional to the torque applied. Suppose we apply the rated torque of the motor and measure the stiffness in degrees. The measured degrees will be the index of the regulator tuning quality. Clearly, it is not the only quality index.

WHAT IS NEEDED

To adjust a SLVD_N converter correctly, an oscilloscope with memory must be used. A technician who can use it to carry out the operation will also be needed. If it is not possible to use an oscilloscope, a more approximate but applicable adjustment method will be illustrated at the end of this section.

BEFORE BEGINNING

Study the diagram below carefully (Fig. 1):

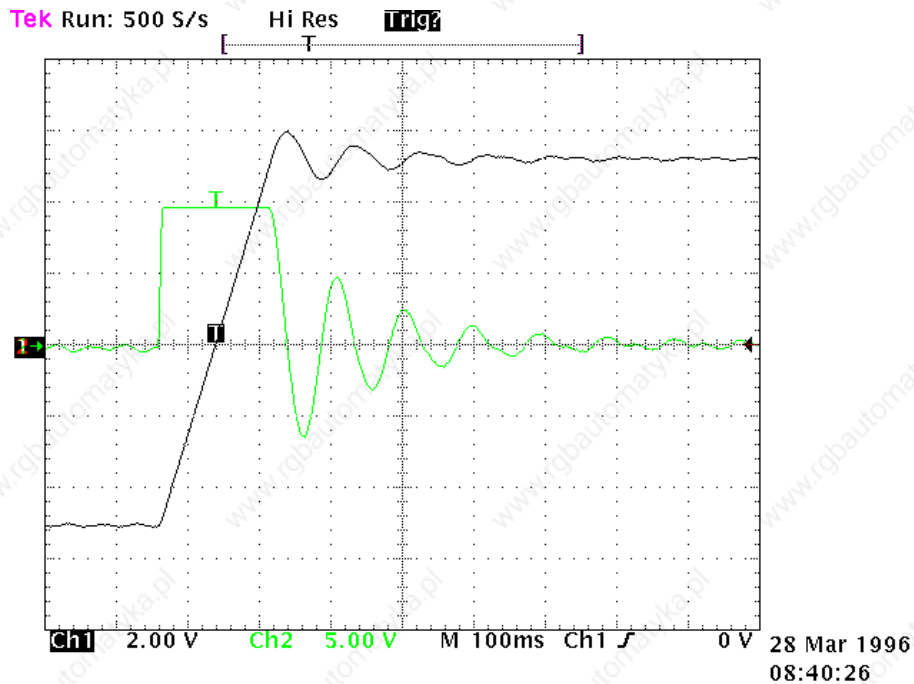

Fig. 1

This diagram shows the response of the system to a square wave speed reference. Channel 1 (Ch1) represents the speed and channel 2 (Ch2) the current of the motor. In practice, the probe has been connected to terminal 6 of the X4 (Vout). The two traces cannot be seen at the same time, but the trace to be displayed can be programmed using the binary parameter b42.4. The V/div scale and the time basis will not be discussed here since they can vary greatly.

ESTIMATING THE Pr16

Before turning the converter on, the user should estimate the value of Pr16. The value of Pr16 is what defines the gain of the system. To convert the value of Pr16 into grades per rated torque, the formula

to be used is the following: $\alpha = \frac{\text{Pr33} \cdot 100}{\text{Pr16} \cdot \text{Ipd}} \cdot 28$ where α represents the stiffness and Ipd is the peak

current of the drive. Before using the formula, Pr33 must be set with the correct value of the rated current of the motor. To evaluate the correct value of α , let's consider that, if the mechanical part to be moved is rigid (non-elastic) and if there is no transmission play, the optimal stiffness would be about 4 degrees. If the mechanical part is not rigid enough, it could be necessary to reduce the gain. If the torque of the motor has been sized in order to obtain strong acceleration, but during the operation, the disturbing torques are very low, it is possible to choose stiffness angles of 20, 30 or 40 degrees, thereby maintaining acceptable performance. If it is difficult to choose the proper stiffness angle, the user can begin with 10 degrees that is the default adjustment if a motor with the same rated current as the converter's is used.

At this point, let us set the Pr16 to the estimate and turn on the axis with a square wave reference. The user must be careful to choose reference ranges and frequencies in order to avoid problems if the axis has a limited course. By observing the oscilloscope we will note that as Pr17 varies, the response will change. For decreasing values of Pr17, the response of the system will be as shown in figure 2 below:

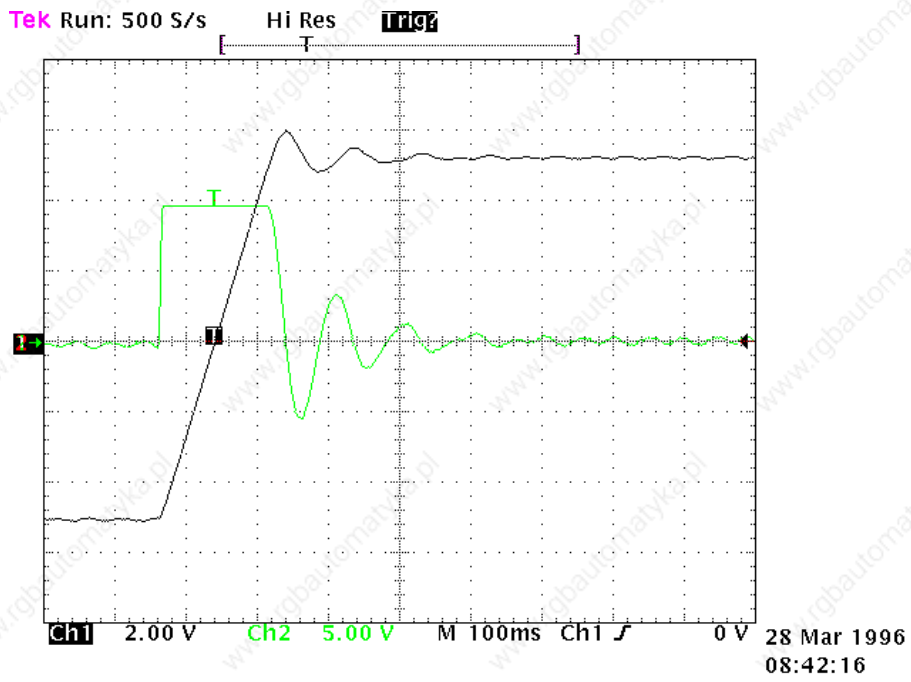

Fig.2

For increasing values of Pr17, the response of the system will be similar to what is shown in figure 3 below:

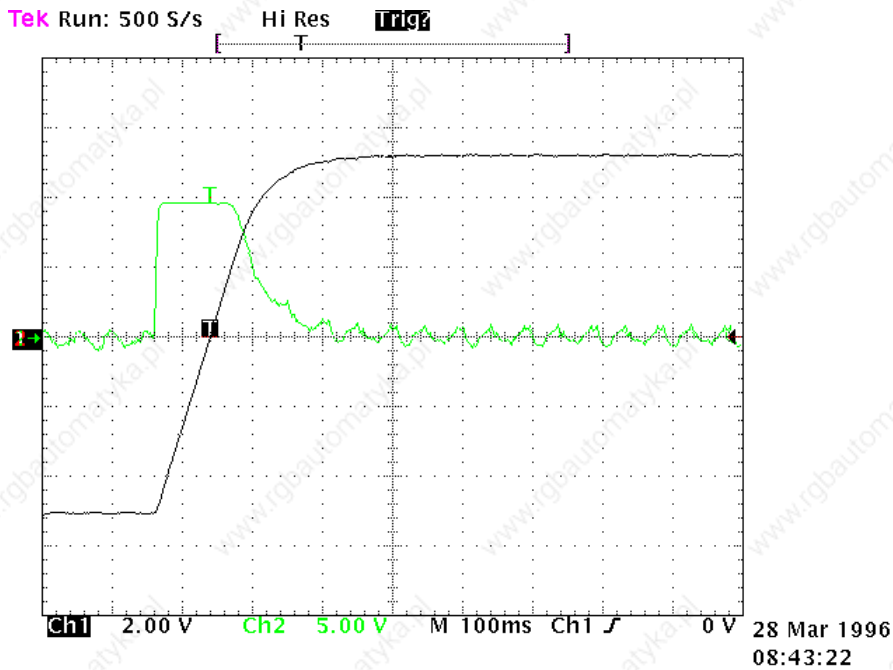

Fig.3

The optimal value of Pr17 will be attained with a response of the system as shown in figure 4 below:

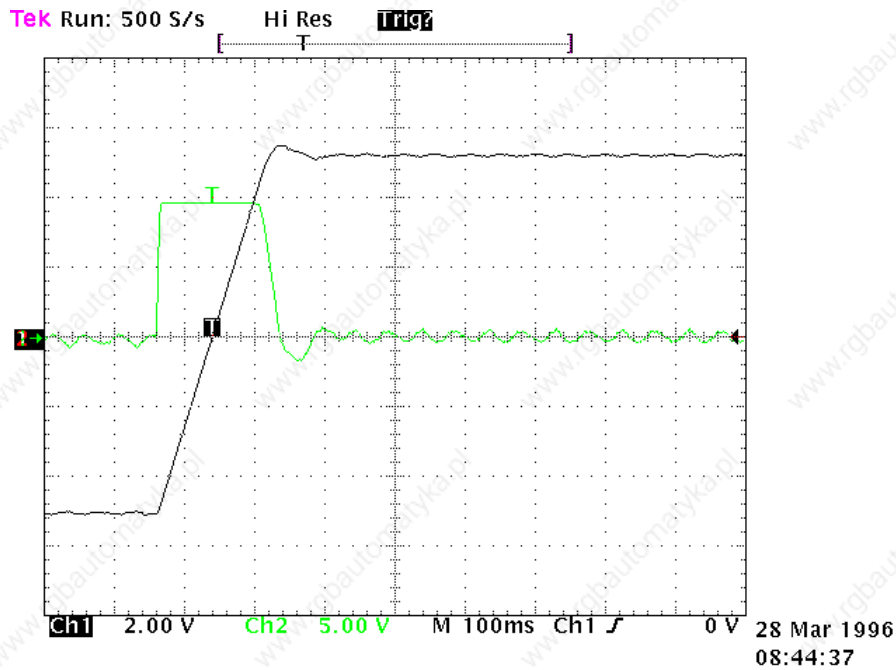

Fig. 4

An overshoot of about 10% must be obtained. It is important that after the overshoot, an undershoot does not occur.

Once the optimal value of Pr17 has been established, we must analyze the movement of the axis. If it moves without vibrations and acoustic noise, the adjustment of the system is complete. Otherwise, we must repeat the preceding procedures with lower values of Pr16.

In some applications it is possible to reduce acoustic noise by using a higher value of Pr18. Figure 5 shows that once the optimal adjustment has been achieved, there is also an oscillation of the current that can produce acoustic noise and mechanical vibration. By raising the value of Pr18 to 3, the situation is much improved (fig. 6).

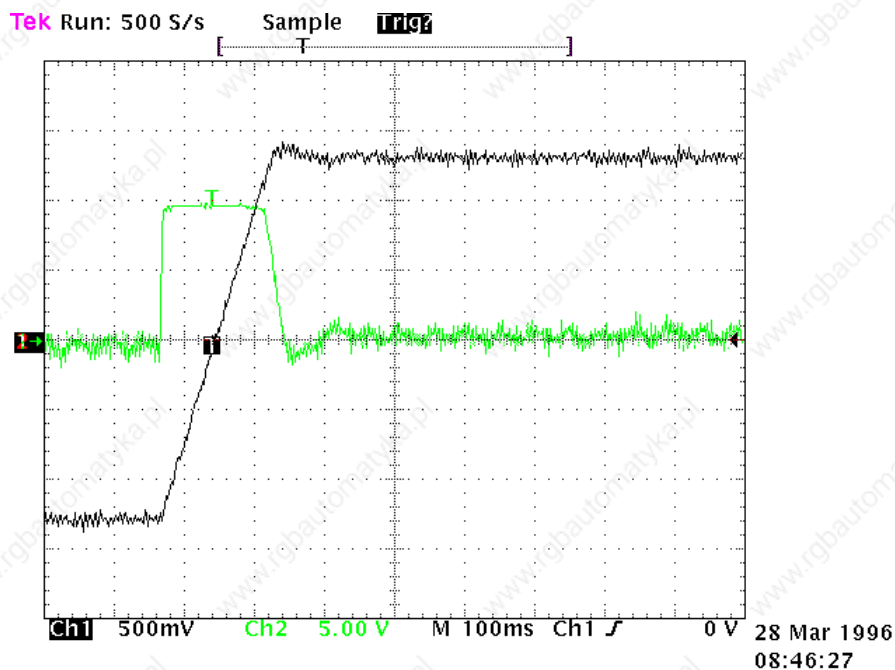

Fig. 5

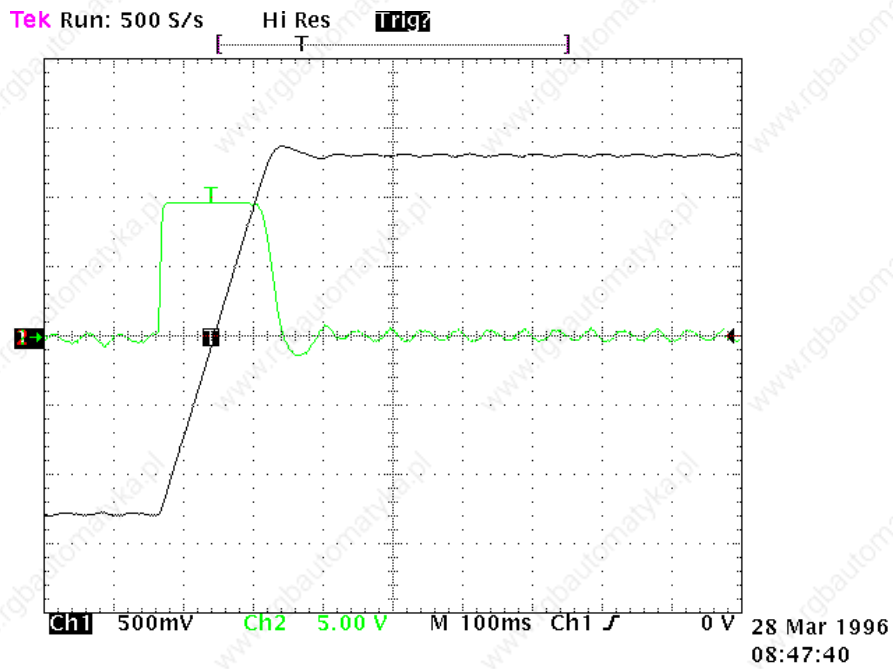

Fig. 6

If mechanical parts are used which very easily tend to enter into oscillation, we recommend you use very low values of Pr16. In this configuration the SLVD_N typically dampens the torque request of the motor in order to avoid triggering mechanical oscillations. This configuration is shown in figure 7.

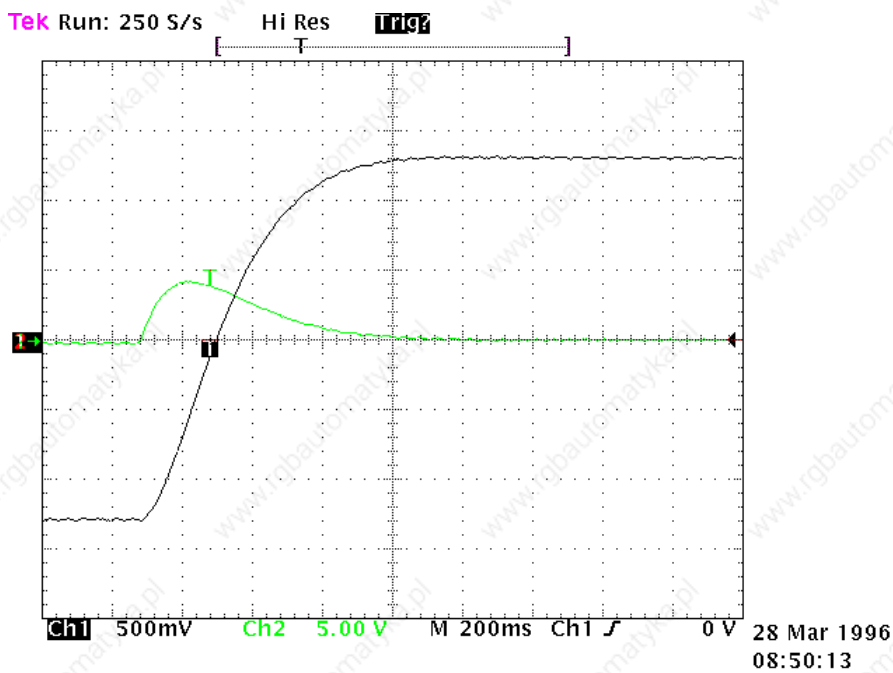

Fig. 7

ADJUSTMENT WITHOUT USING INSTRUMENTATION

If you do not have an oscilloscope, you must:

- a) Determine the value of Pr16 as described above.
- b) Determine the Pr17 parameter by using the following formula:

$$\text{Pr 17} = 1488 \cdot \sqrt{\frac{153.41 \cdot \text{Pr 16} \cdot J_{\text{tot}}}{Nm_{\text{picco}}}}$$

where: J_{tot} is the total inertia (motor + load) expressed in kgm^2 .

Nm_{picco} is the available torque with the peak current of the converter.

- c) Turn on the converter and use the external control to move the axis. Move Pr17 to find the value where the axis seems to move best.
- d) Estimate the value of Pr18 by using the following formula:

$$\text{Pr 18} = 0.68 \cdot \frac{\text{Pr 17}}{\text{Pr 16}}$$

If the result is less than 1, Pr18 must be set to 1.

If the adjustment is not satisfactory, repeat the procedure with lower values of Pr16.

6 PARAMETERS AND PROGRAMMING

The torque, speed, acceleration and position control functions are carried out by special digital electronics.

In this section we explain how parameters are set and the meaning of each parameter. We also provide the functional block diagram and the description of advanced functions. The system is easy to use and flexible.

In the diagram below the general block diagram of the part of the converter that is controlled by parameters is presented.

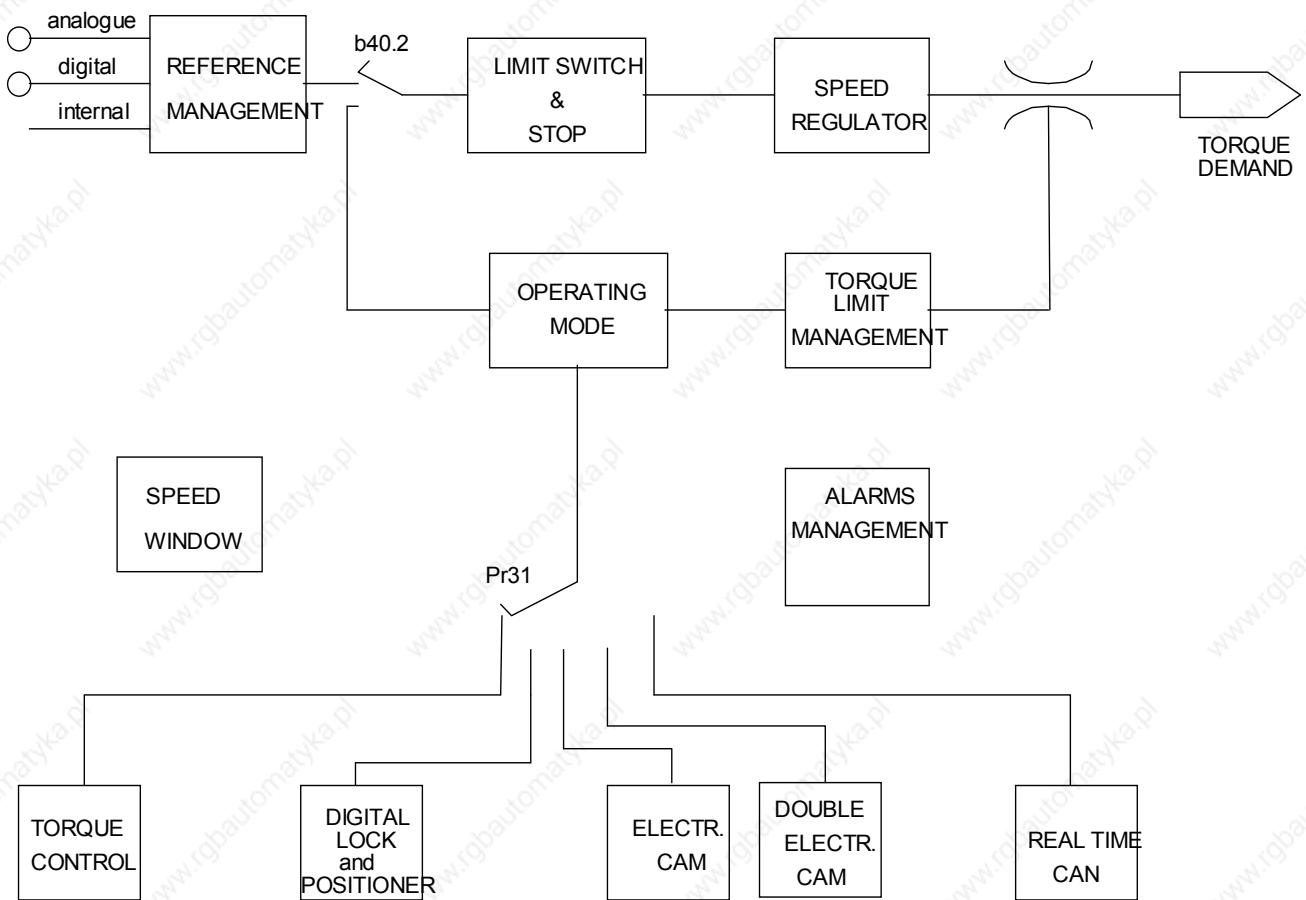

The main block diagram and the diagrams for special functions (operating modes) are described later in more detail.

How to associate inputs/outputs to the parameters of the converter is described in the chapter, *The pico-PLC*.

The parameters are divided on the basis of their function in the following way.

Pr0...Pr49, Pr151...Pr167, Pr188...Pr280	Main parameters
Pr50...Pr70	Position loop
Pr71...Pr99	pico-PLC parameters
Pr100...Pr150, Pr168...Pr187	Operating mode parameters
From Pr151 to Pr163	pico-PLC parameters
From In0 to In255	pico-PLC instructions

The units of measurement and the main resolutions of the parameters are:

Parameter type	Unit	Resolution
Speed	Revolutions/minute	1
Acceleration	Seconds/1000 revolutions/minute.	0.001
Position	4096 steps/revolution	1/4096 of a revolution
Current	% of the peak current of the converter	0.1

Below we describe how to interpret the symbols used in the block diagrams. The main block diagram describes graphically how the converter works. Each rectangular block represents one or more read-write parameters. The rhomboid blocks represent read-only parameters. You can find other functional blocks in the diagram such as: GREATER THAN, EQUAL TO, LESS THAN, logical AND/OR. For all these functional blocks, standard symbols are used. Binary parameters are represented as switches and the position in the diagram corresponds to the default value.

Reduced and extended menu

When the SLVD_N is in the default status, only a limited number of parameters is displayed. These parameters are the only parameters necessary for those applications where the SLVD_N is used as a simple converter and where the advanced functions of the converter, for example, if the SLVD_N is used with a numeric control or with an intelligent axis board, are not used. To switch between the limited menu and the extended menu, enter b99.6: limited menu if equal to 0, extended menu is 1.

The parameters in the limited menu are:

- Pr0 Actual speed of the motor shaft in rpm (revolutions per minute).
- Pr1 Offset for the main analogue reference.
- Pr2 Full scale of the analogue reference: this is the rpm value that corresponds to a reference voltage of 10 V.
- Pr8 Value of the acceleration/deceleration ramps in seconds per 1000 rpm, with a resolution of 1 millisecond. If the acceleration/deceleration ramps must be set differently, you must go to the extended menu in order to access the Pr9, Pr10 e Pr11 parameters.
- Pr16 Integral gain of the speed regulator.
- Pr17 Speed regulator damping.
- Pr19 Peak current supplied by the converter, expressed as a percentage of the peak drive rating.
- Pr29 Number of poles of the motor.
- Pr32 Rated speed (rpm).
- Pr33 Rated current supplied by the converter (which can be maintained indefinitely) expressed as rated current of the motor (A).
- Pr35 Instantaneous current required by the motor expressed as a percentage of the peak drive rating.
- Pb99 Bit parameter for the basic commands.

The extended menu offers access to all the parameters and instructions of the pico-PLC, in addition to those specified above.

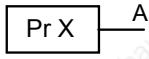

- Read/write of the PrX parameter
A = value of the PrX parameter

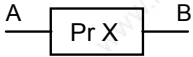

- Read/write of the PrX parameter
B = value that depends on the values of A and PrX

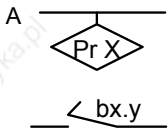

- Read-only parameter
PrX indicates the value of A which can also be binary
- Read/write of binary parameter
The position of the switch indicates $bx.y=0$

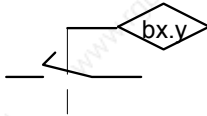

- The value of the binary parameter $bx.y$ positions the switch.

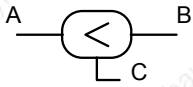

- If A is less than B, $C = 1$ (true). Otherwise, $C = 0$ (false).

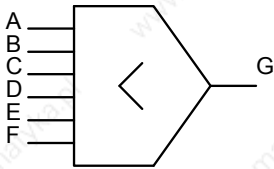

- The value of G is the lowest value of A B C D E F.

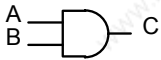

- Only if $A = 1$, $B = 1$ and $C = 1$. Otherwise, $C = 0$.



- If A or B is equal to 1, $C = 1$. Otherwise, $C = 0$.

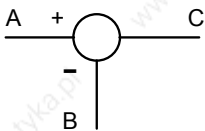

- $C = A - B$.



- values coming from the hardware



- values sent to the hardware

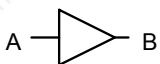

- the value of A is converted to B. For example, if in the triangle symbol you see A/D, this means that the analogue value of A was converted into the digital value B.

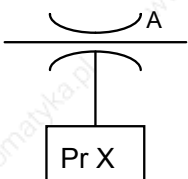

- The maximum value of A will be PrX.

6.1 Main parameters

Legend: **R**: read; **W**: write; **M**: memory; **K**: key parameter.

Par.	Descrizione	Campo	Def.	Tipo/ Note
Pr 0	Motor speed: a read-only parameter expressed in rpm; the Pr0 message is not ever displayed on the screen. Instead, the message indicating the status of the converter is displayed.	± 9000 [rpm]		R
Pr 1	Analogue reference offset. Expressed as a count of the input converter.	± 10000 [1≈0.3 mV]	0	W M
Pr 2	First full scale of analogue reference: Unit = rpm, range=±10000, default=3000. If b40.0=0 and b40.12=0, the value of Pr7 will be equal to: $V_{in} \cdot Pr2 / 9.76$ where V_{in} is the voltage at the analogue input.	± 10000 [rpm]	3000	W M
Pr 3	Second full scale of the analogue reference: Unit = rpm, range=±10000, default=3000. If b40.0=0 and b40.12=0, the value of Pr7 will be equal to: $V_{in} \cdot Pr2 / 9.76$ where V_{in} is the voltage at the analogue input. If b42.0=1, b42.1=0, and b42.5=1, Pr3 is the speed of the virtual axis.	± 10000 [rpm]	3000	W M
Pr 4	Full scale of frequency reference: (connector X3). Unit = rpm, range=±32767, default=3000. If b40.12=1 and b40.13=1, the value of Pr7 will be the following: If b42.5=0, $Pr7 = Fin \cdot Pr4 * 2 / 2000000$ (frequency/sign signals) If b42.5=1, $Pr7 = Fin \cdot Pr4 * 2 / 500000$ (quadrature signals) where Fin is the frequency present at the encoder input: $Fin = \text{enc speed [Rpm]} * \text{enc pulses turn} / 60$	± 32767 [rpm]	3000	W M
Pr 5	Internal reference: If b40.12=1 and b40.13=0, Pr7 will be equal to Pr5.	±9000 [rpm]	0	W M
Pr 6	Reserved speed reference (read-only): If b40.2=1, this value is used as a reference for the speed regulator. The active operating mode will write its speed request in parameter Pr6.	±9000 [rpm]	0	R
Pr 7	Main reference (read-only): If b40.2=0 is used, Pr7 is the reference for the speed regulator. In some operating modes Pr7 can be used as a reference for other values (torque/acceleration) and in these cases Pr7 will be expressed in the most suitable unit of measurement.	±9000 [rpm]		R
Pr 8	Acceleration ramp for positive speed: Positive speed acceleration required by the motor via the speed reference is internally limited so that to achieve an acceleration of 1000 rpm, Pr8 seconds are necessary.	0.002÷ 65.535 [s/krpm]	0.002	R/W M

Par.	Descrizione	Campo	Def.	Tipo/ Note
Pr 9	Deceleration ramp for positive speed: Positive speed deceleration required by the motor via the speed reference is internally limited so that to achieve an acceleration of 1000 rpm, Pr9 seconds are necessary.	0.002÷ 65.535 [s/krpm]	0.002	R/W M
Pr 10	Acceleration ramp for negative speed: Negative speed acceleration required by the motor via the speed reference is internally limited so that to achieve an acceleration of 1000 rpm, Pr10 seconds are necessary.	0.002÷ 65.535 [s/krpm]	0.002	R/W M
Pr 11	Deceleration ramp for negative speed: Positive speed deceleration required by the motor via the speed reference is internally limited so that to achieve an acceleration of 1000 rpm, Pr11 seconds are necessary.	0.002÷ 65.535 [s/krpm]	0.002	R/W M
Pr 12	Deceleration ramp for limit switch and stop functions: Deceleration required by the motor for limit switch and stop functions is internally limited so that to achieve an acceleration of 1000 rpm, Pr12 seconds are necessary.	0.002÷ 65.535 [s/krpm]	0.002	R/W M
Pr 13	Overspeed limit: If the absolute value of the motor speed exceeds the value set in Pr13, b41.0 will be =1, Otherwise, it will be = 0.	0÷13000 [rpm]	3500	R/W M
Pr 14	High speed limit: If b40.7=0 and if the difference of the speed of the motor and the reference is less than Pr14 and greater than Pr15, b41.1 will be = 1. Otherwise, it will be 0. If b40.7 = 1 and if the motor speed is less than Pr14 and greater than Pr15, b41.1 will be =1. Otherwise, it will be =0.	±13000 [rpm]	20	R/W M
Pr 15	Low speed limit: If b40.7=0 and if the difference of the speed of the motor and the reference is less than Pr14 and greater than Pr15, b41.1 will be =1. Otherwise, it will be =0. If b40.7=1 and if the motor speed is less than Pr14 and greater than Pr15, b41.1 will be =1. Otherwise, it will be =0.	±13000 [rpm]	-20	R/W M
Pr 16	Integral gain of the speed regulator.	0÷32767	120	R/W, M
Pr 17	Damping of the speed regulator: If Pr16=0, Pr17 is the proportional gain of the speed regulator.	0÷32767	2000	R/W M
Pr 18	Band width limiter: Pr18 is used to set the time constant of a first order filter placed on the digital signal of the torque request. The frequency of the filter cut will be: 1240/Pr18 Hertz.	1÷1000 [1=128 µsec]	3	R/W M
Pr 19	Peak current: This is the maximum current that the converter can supply to the motor. It is expressed as a percentage of the peak current of the converter. In general, it should never exceed three times the rated current of the motor.	0÷100.0 [%Ip]	100.0	R/W M
Pr 20	DC bus voltage: Displays the value of the voltage present on the DC bus.	0÷850 [Volt]		R
Pr 21	Torque limiter (read-only): Can be used by the operating modes to limit the torque to the motor.	0÷100 [%Cn]		R
Pr 22	Auxiliary analogue reference: The value displayed will be Pr22=Vin·100/9.76. The resolution is of 0.2%.	±100 [%]		R

Par.	Descrizione	Campo	Def.	Tipo/ Note
Pr 23	Alarm code: This is the code for the alarm that is present. Code 0 represents the absence of alarms. Consult the table of alarm codes for more details.	0÷255		R
Pr 24	Latest alarm: This parameter contains the latest alarm. Pr24 will be set to 0 during the execution of the alarm reset command (b99.10).	0÷255		R M
Pr 25	Software version code (read-only): Indicates the version of the software that has been installed.	0÷255		R
Pr 26	Serial line speed code: This is the code for programming the transmission speed. For more information, consult the section on the serial interface.	0÷8	5	R/W M
Pr 27	Serial line address code: For more information, consult the relevant section.	0÷31	0/1	R/W M
Pr 28	Motor shaft position (read-only): Indicates the absolute position of the resolver.	0÷4095 [count]		R
Pr 29	Number of motor poles.	2÷64	0	R/W K,M
Pr 30	Offset of the resolver position: Used to correct electronically the mechanical position of the resolver.	± 32767	0	R/W M
Pr 31	Operating mode: Used to select the active operating mode. The value 0 means that no operating mode has been selected.	0÷15	0	R/W M
Pr 32	Rated speed: This is the rated speed of the motor. The speed that has been set is used to limit the speed request. Therefore, it should be set to about 10% greater than the maximum operational speed.	0÷10000 [rpm]	0	R/W K,M
Pr 33	Rated current of the motor: The rated current of the motor must be set.	0.1÷In [A]	0	R/W K,M
Pr 34	Number of poles on the resolver: must be ≤ Pr29	2÷4÷8	0	R/W K,M
Pr 35	Torque monitor: Unit = % of the torque at peak current, resolution 0.1%. Indicates the percentage of the torque or of the current that the motor is supplying.	0÷100.0 [%]		R
Pr 36	Thermal image winding (read-only): Unit = % of the rated temperature. Indicates the estimate of the heat in the innermost coils of the motor. If this reaches the value of 100.0 % equal to the nominal value, b41.11 will become 1 and therefore the current will be limited to the nominal value. Description: if the drive generate the max current, starting from 0 current, after 2s, Pr36=100% and b41.11=1 result: the drive limits the current at the rated current. This situation remains until the drive generates "0" current and after 35s Pr36 is "0" again.	0÷100.0 [%Temp]		R
Pr 37	Thermal image of the braking resistor (read-only): Unit = % of the rated temperature. Indicates the estimate of the heat of the braking resistor. If the value reaches 120.0 %, the converter issues an alarm.	0÷100.0 [%Temp]		R

Par.	Descrizione	Campo	Def.	Tipo/ Note
Pr 43	Zero encoder offset. This parameter is used to modify the position of the output zero trace for the zero resolver (Pr28).	0÷4095 [count]	0	R/W M
Pr 44	Number of pulses per revolution. This is the number of pulses per revolution that is used by the simulation encoder. If b231.1=0 the range is from 4 to 65535 pulses per rev., if b231.1=1 the number is a exponent of base 2, the max value is 18. 160 kHz is the maximum frequency. $F_m = \frac{\{\text{impulsi encoder}\} \times \{\text{velocità [rpm]}\}}{60 [\text{sec/ min}]} \leq 160 [\text{kHz}]$	4÷65000 [count]	1024	R/W M
Pr 45	Main analogue input: Represents the value of the main analogue input.	±32767 [±10V]		M
Pr 46	Motor resistance: The phase-phase resistance of the motor.	0.1÷300.0 [Ohm]	0	K,M
Pr 47	Motor inductance: The phase-phase inductance of the motor.	0.1÷500.0 [mH]	0	K,M
Pr 48	CAN bus speed code: Default=0, see the section <i>CAN bus</i>	0÷7	0	M
Pr49	CANopen address. see the section CANopen.			
Pr164	Speed feedback filter.	1÷255	100	
Pr188	Analogue output pointer. The number indicates which parameter to monitor. It comes used with to the Pr189. If the parameter pointed is Pr0, will be had in escape ±10V when Pr0=Pr32. if the parameter pointed is Pr35, will be had in escape ±10V when Pr35 is equal to the pick current. For the other parameters, the range in escape is ±512 counts = ±10V. Therefore if the parameter to monitor necessity more counts, is necessary to attribute to Pr189 a such value to bring back the scale of reading of the parameter within the 512 counts: 2^{Pr189} (see par. "analogue outputs programmable").			
Pr189	Analogue input scale. Defines the scaling of the analogue output.		0	
Pr196	No. of FBK. Encoder pulses. Indicates the number of pulses per revolution (times 4 in the count) ranging from 1 to 32767, and it can be set <0 to reverse the count only with incremental encoders and not with SinCos encoders, as the latter require a correct cabling of sine-cosine signals (traces A and B).	-32767÷ +32767	1024	R/W M
Pr197	Feedback break threshold. Amplitude sinusoidal signals threshold (resolver and encoder).	1÷500 [count]	210	
Pr200	N. of turn for Multiturn encoder. In the case of encoder multiturn the parameter show the maximum turn of the device.	[turn]	0	
Pr201	Encoder vibration step. (see section "encoder phasing")			
Pr202	Encoder CAN address. (see section "encoder CAN")			
Pr206	Nominal DC BUS. When the drive is supplied in continuous voltage, the power supply voltage value must be written in this parameter. The voltage must not inferior to 12V. This configuration is enabled at the start-up the drive. With b39.0=1 is enabled the undervoltage alarm.			

Par.	Descrizione	Campo	Def.	Tipo/ Note
Pr207	Overvoltage limit. If b39.1=1, overvoltage and braking alarm. This value decides the braking limit and the overvoltage alarm. It's important to know well the characteristics of the drive before setting this value for avoid serious damages to the drive.	-32767÷ +32767		R/W M
Pr208	Braking resistance.. In "Ω".		40	R/W M
Pr209	Power of the braking resistance. In "W".		120	R/W M
Pr217	Selection (0) synchronous motor (1) asynchronous motor. 0: rotative brushless motor, 1: asynchronous motor 4 poles to vectorial control with sensor.	0÷1	0	R/W M
Pr218	Base_speed_asinc. Asynchronous motor speed in synchronism conditions.	[rpm]	0	R/W M
Pr219	SLIP_ASINC. Asynchronous motor slip.	0÷32767 [rpm]	0	R/W M
Pr220	MAGN_CURR_ASINC. Asynchronous motor magnetizing current. $\text{Pr 220} = \text{Pr33} \times \sqrt{1 - \cos^2 \varphi}$	0÷32767 [A]	0	R/W M

6.2 Binary parameters

Par.	Description	Def.	Field
b39.0	Undervoltage in continuous current. b39.0=1 When the drive is supplied in continuous voltage, this bit permits the control of the undervoltage alarm.		
b39.1	(1) Abilitato Pr207 - Valore soglia di sovratensione e di frenatura impostati a partire da Pr207. Se viene abilitato questo bit, occorre impostare il valore di soglia della massima tensione nel parametro Pr207.	0	R/W M
b39.2	(1) if feedback supply is active.		
b39.3	Power supply <150Vac.		
b39.4	Mains not 3 phase. When the mains is not 3 phase, the bit is equal to 1.		
b39.9	(1) Encoder zero point dog fine tuning.		
b39.13	CANopen: send user fault. User alarm message.	0	
b39.14	CANopen Node Guard watchdog. (see par. "CANopen").		
b39.15	Watchdog dell'encoder CAN.		
b40.0	Selection of the first or second full scale of the speed reference: If = 0, Pr2 will be used to rate the analogue reference. If = 1, parameter Pr3 will be used.	0	R/W M
b40.1	Activation of the algorithm to suppress vibration at 0 speed: If = 1, the algorithm is turned on.	0	R/W M
b40.2	Selection of the reserved/user reference: If = 1, the reserved reference of the operating mode in use is used. If = 0, the reference selected by b40.0, b40.12 and b40.13 is used.	0	R/W M
b40.3	Reference hold: If = 1, the reference will not be updated and the motor will not follow the variations of the input reference. If = 0, the reference will follow the variation of the input reference.	0	R/W M
b40.4	Left limit switch: If = 1 and the reference selected requires negative speed, the reference is set to 0 following the ramp set in Pr12. If = 0, no control is made.	0	R/W M
b40.5	Right limit switch: Default=0. If = 1 and the reference selected requires negative speed, the reference is set to 0 following the ramp set in Pr12. If = 0, no control is made.	0	R/W M
b40.6	Stop function: If = 1, the motor is set to zero speed following the ramp set in Pr12.	0	R/W M
b40.7	Selection of the absolute/relative speed window: If = 0, the speed window Pr14 Pr15 b41.1 will function in relative mode. Otherwise, if = 1, it will function in absolute mode.	0	R/W M
b40.8	Analogue torque limit: Default=0. If = 1, Pr22 will be used and also the auxiliary analogue input in order to limit the torque to the motor. The sign of voltage at aux. differential analog input doesn't interest.	0	R/W M
b40.9	Software enable: If = 0, the converter cannot be enabled.	1	R/W M
b40.10	Low voltage. Activates low voltage management (from 40 to 180V~, and from 57Vdc to 255Vdc), so the maximum speed of the axis is lower.	0	W

Par.	Description	Def.	Field
b40.11	Injection of third harmonic in modulation.	0	W
b40.12	Selection of the digital/analogue reference: If = 0, the analogue input will be selected as the main reference. If = 1, the reference will be digital and b40.13 can be used to select parameter Pr4 or parameter Pr5.	0	R/W M
b40.13	Selector of internal reference Pr5 or frequency reference Pr4: If b40.12 = 1, b40.13 can be used to make the selection. If = 0, the internal reference can be used. If = 1, the frequency input (encoder-in) which can be configured as frequency/direction or as a quadrature signal by using b42.5.	0	R/W M
b40.15	Reserved.	0	R
b41.0	Overspeed: When the absolute value of the motor speed exceeds the value set in Pr13, b41.0 = 1. Otherwise, b41.0 = 0.		R
b41.1	In speed: If b40.7 = 0 and if the difference in speed between the motor and the reference is less than Pr14 and greater than Pr15, b41.1 = 1. Otherwise, = 0. If b40.7=1 and if the motor speed is less than Pr14 and greater than Pr15, b41.1 =1. Otherwise, = 0.		R
b41.2	Zero speed: If the motor speed (Pr0) = 0, b41.2=1. Otherwise, b41.2 = 0.		R
b41.3	Forward: If the motor speed (Pr0) is positive, b41.3 = 0. Otherwise, b41.3 = 1.		R
b41.4	Converter O.K.: If = 1, there is no alarm. Otherwise, = 0.		R
b41.5	Status of hardware enable: When hardware enable is present, = 1 (by pico-PLC, via serial line or CAN bus).	0	R/W
b41.6	Phasing result :=1 if positive result		R
b41.7	External alarm: An alarm that can be used by the user.	0	R/W
b41.8	Auxiliary alarm. A second alarm that can be used by the user..	0	R/W
b41.9	CANbus watchdog. This bit is set to 1 at every block sync reception via SBCCAN.		R
b41.10	Saturation of the speed regulator: b41.10=1 when the speed regulator is supplying the maximum current.		R
b41.11	I2T active: Indicates that Pr36 has reached the 100.0 % value and therefore the converter is limiting the current to the nominal value.		R
b41.12	Converter enabled.		R
b41.13	CAN bus warning. Indicates a momentary communication error on the SBCCAN.	0	R
b41.14	CAN bus off error. Indicates a permanent communication error on the SBCCAN.	0	R
b41.15	CAN bus watchdog. This bit is set to 1 at every sync (0 or 1) reception via SBCCAN.	0	R
b42.0	Virtual encoder enabled: 1= function enabled. See the section, <i>Other useful functions..</i>	0	R/W M
b42.1	Encoder CAN. See par. "Encoder CAN".	0	R/W M
b42.2	Torque control: If set to 1, the main analogue reference is assumed as the reference for the torque control (torque servocontrolled mode).	0	R/W M

Par.	Description	Def.	Field
b42.3	Reinitializing the serial line and the SBCCAN. Command to initialise serial communication whenever the speed value of the serial line (Pr26) has been modified. Command to initialise the SBCCAN whenever the address or the function mode has been modified. The serial line and the SBCCAN are in any case initialise when the converter is powered on.	0	R/W M
b42.4	IN2/IN3 frequency input If it is 1, the frequency input is programmed to receive two phases in quadrature. If it is 0, it is enabled to receive a frequency/direction input.	1	R/W M
b42.5	Encoder frequency input If it is 1, the frequency input is programmed to receive two phases in quadrature. If it is 0, it is enabled to receive a frequency/direction input.	1	R/W M
b42.6 b42.7 b42.8 b42.9	Selection the type of feedback. Is possible choose between resolver and encoder. (see the par. "setting feedback")		M
b94.0	Force a double word formatted operation. When the unit is powered on, this is 0. If it is set to 1, the first mathematical operation executed by the pico-PLC is done by using three double word type operands. After the execution of the operation b94.0 is automatically set to 0. If Pr60..Pr68 Pr110...Pr148 are used, the double word formatting is implicit.	0	R/W
b94.1	Command to set the main reference offset to 0. This command is used to automatically set the Pr1 parameter in order to automatically set the voltage offset on the main analogue reference to 0. This operation can be done only if the absolute value of the offset is less than 200 mV.	0	R/W
b94.2	Command phasing 1	0	R/W
b94.3	Basic parameters keylock. If set to 1, it is possible to modify the basic parameters		
b94.4	Command phasing 2	0	R/W
b94.8	Value comparator. See the section, <i>Other useful functions.</i>		
b94.9	Value comparator. See the section, <i>Other useful functions.</i>		
b94.10	Value comparator. See the section, <i>Other useful functions.</i>	0	R/W
b94.11	Value comparator. See the section, <i>Other useful functions.</i>	0	R/W
b94.12	Homing 1 See the section, <i>Other useful functions.</i>	0	R/W
b94.13	Homing 2 See the section, <i>Other useful functions.</i>	0	R/W
b94.14	Set absolute position on encoder Multiturn. Defines the machine "zero" position. The command must be given while the drive is disabled. In order for this function to be available,, save the parameters and switch the drive off and on again (disables the drive and prevents any further enabling command. To enable the drive you'll need to switch it off and on again).	0	W
b99.5	Enable transmission CANopen blocks.		
b99.6	Extended menu enable: If set to 1, the extended menu is enabled.	0	R/W M
b99.7	Safety: If set to 1, parameters cannot be modified.	0	R/W M
b99.8	UV auto reset: If set to 1, the under-voltage alarm will automatically be set to 0 when power returns.	0	R/W M
b99.9	Motor phase saved on absolute encoder (EnDat interface).		

Par.	Description	Def.	Field
b99.10	Command to reset alarms. This command sets Pr23 and Pr24 to 0. If the alarm continues, it is displayed on the screen. This command cannot be used if there is a check-sum error (Pr23 = 10, 11). In this case, it is necessary to set the default parameters (b99.12) and then reset the alarm.	0	R/W
b99.11	Default values of the parameters in operating mode. This command sets the operating mode parameters to the default values. The command is executed only if b40.2 = 0.	0	R/W
b99.12	Default values. This command sets all parameters to the default values and sets those used by the operating mode to 0. Furthermore, it sets the pico-PLC program as described in <i>Appendix</i> . There is a check-sum alarm, Pr23 and Pr24 will be set to 0, thereby permitting the alarm to be reset. The command is executed only if b99.13 = 0.	0	R/W M
b99.13	pico-PLC	1	R/W M
b99.14	Storing of the pico-PLC instructions. This command saves the pico-PLC program. It cannot be used if a check-sum alarm has been indicated. In this case, it is necessary to set the default parameters, reset the alarm and then store the new parameters.	0	R/W
b99.15	Storing of parameters. This command stores all parameters. It cannot be used if a check-sum alarm has been indicated. In this case, it is necessary to set the default parameters, reset the alarm and then store the new parameters.	0	R/W
b231.1	Set encoder pulses as exponent on base 2. Decides the value of Pr44	0	R/W
b231.2	Multiturn feedback read. (1) recognise a multiturn encoder.	0	R/W
b231.5	Time out pico-PLC.	0	R/W
b231.6	Select supply voltage of feedback. (see the par. Select supply voltage).	0	R/W
b231.7	Select supply voltage of feedback. (see the par. Select supply voltage)..	0	R/W
b231.10	(1) enable profiles on TAB0. Enable profile on Tab0.		
b231.11	Motor control PWM (0) 8 kHz – (1) 4 kHz . If =1, the first time the drive is powered on again PWM at 4kHz is enabled. (The setting is enabled, after had saved the parameters, at the next power on). (*) only for SPD16N, default is b231.11=1, if is enabled the PWM at 8kHz, the peak current of the drive is limited to 75% (24Arms).	0 (*)	R/W
b231.12	PTC motor pre-alarm (1). This pre-alarm allows to stop the machine before (around 125°C – 257°F) reaching the alarm limit (around 135°C – 275°F).	0	R

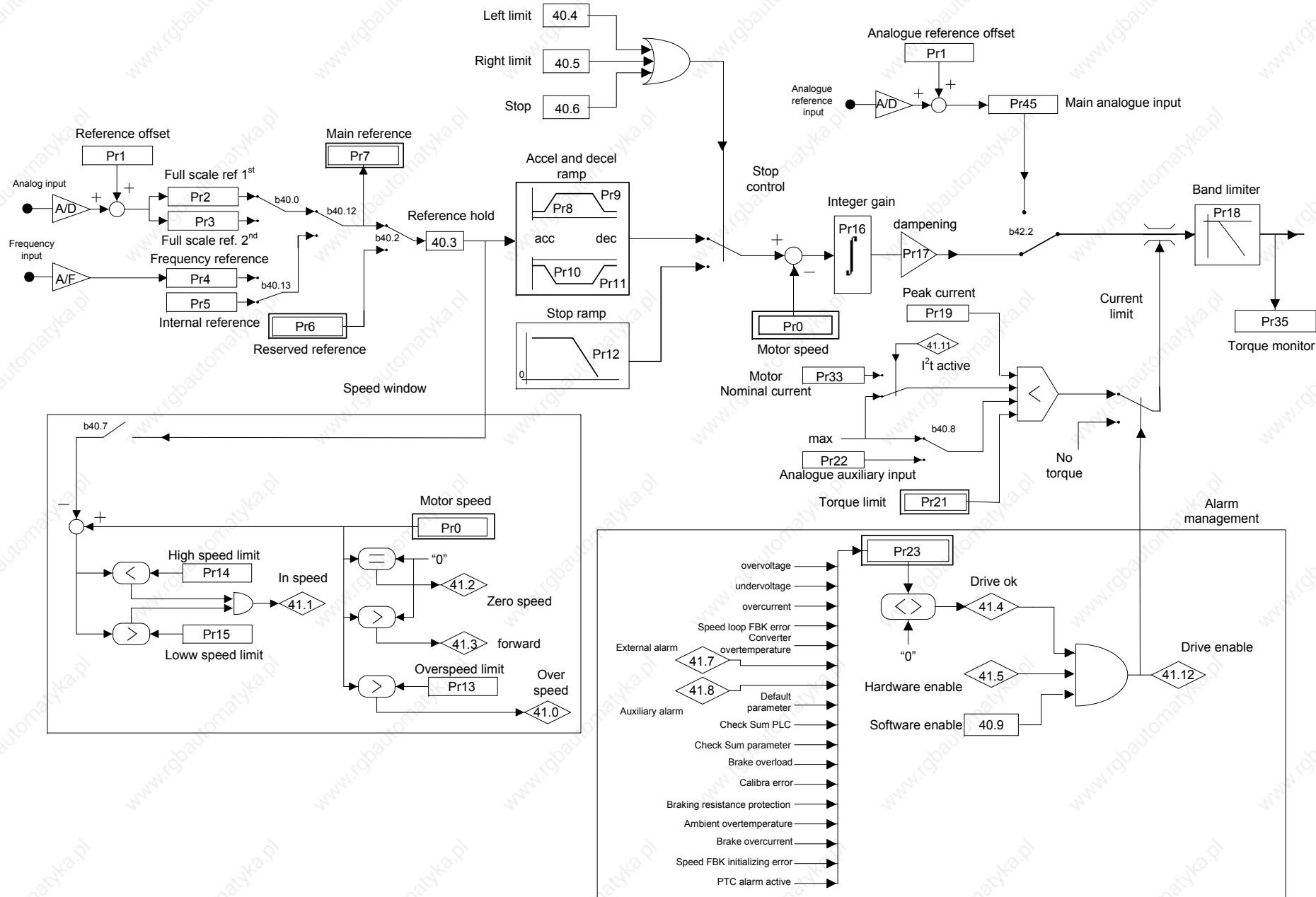

7 Operating modes

Parameter Pr31 (default = 0) is used to select the operating mode. Every operating mode controls speed using parameter Pr6 and can use parameter PR21 to limit the torque at the motor (see the block diagram). Speed control will use as reference Pr7 or Pr6, depending on the value of b40.2. Before changing Pr31, b40.2 must be set to 0 in order to avoid unwanted movements of the motor. Therefore, it is possible to set Pr31 to the value that corresponds to the selected operating mode. The parameter b99.11 is used to load the default parameters for the selected operating mode. By setting b40.2 to 1, the operating mode will be turned on. All operating modes need to control the motor in position (11, 13, 14, 15) by using the position loop described in the diagram in the figure.

7.1 Position control

All operating modes need to control the motor in position by using the position loop described in the block diagram shown in the figure below.

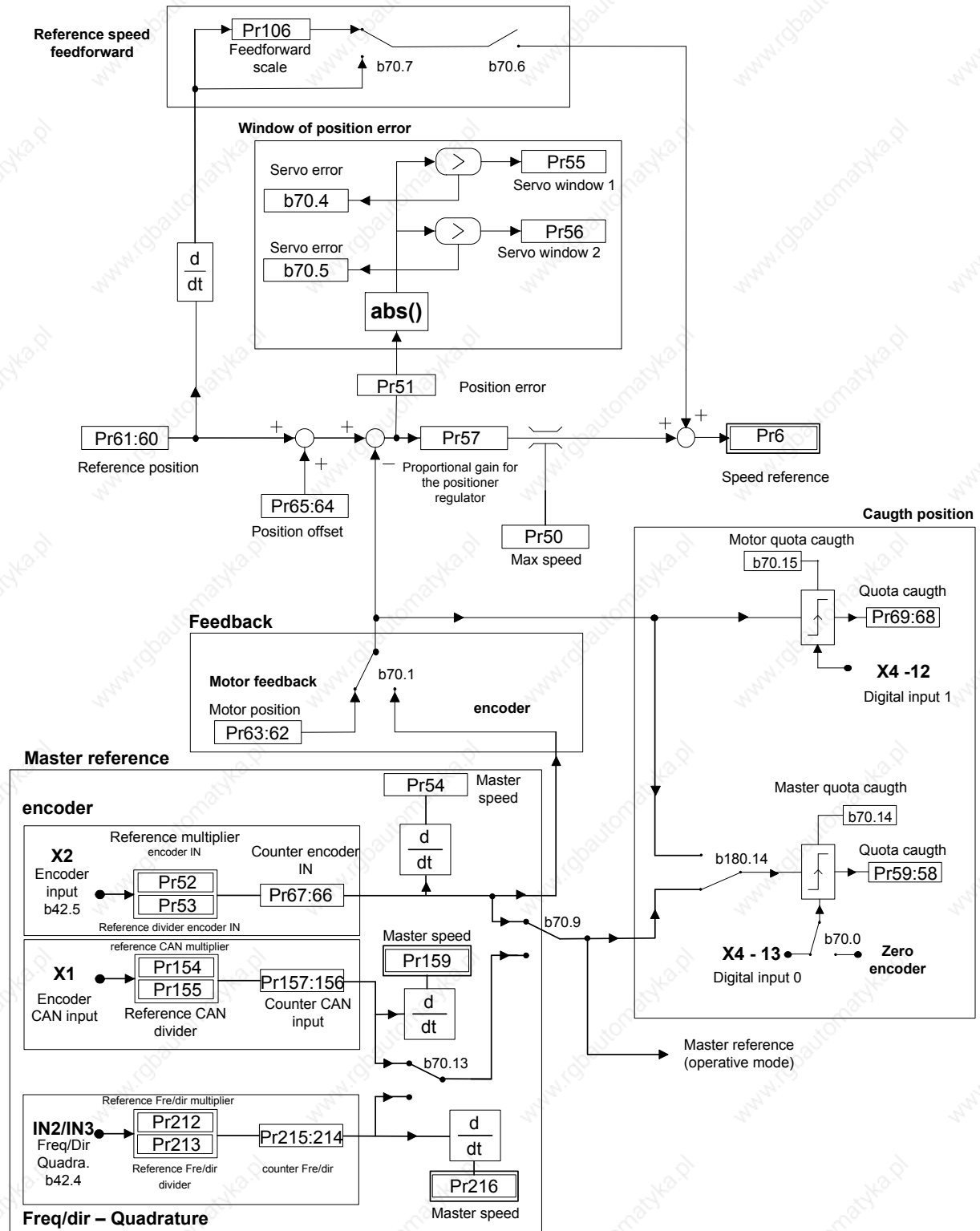

Par.	Description	field/Unit	Def.	Type /Note
Pr50	Maximum speed. This parameter limits the maximum speed of the motor. It can be useful to limit the speed during a sudden link or during a quick change of speed.	0÷9000 [rpm]	3000	R/W M
Pr51	Position error.	-32768 ÷ +32767 [count]	0	R/W M
Pr52	Reference multiplier. Using this parameter and Pr53, the user can set the ratio desired for the input reference frequency.		1	R/W M
Pr53	Reference divider. Using this parameter and Pr52, the user can set the ratio desired for the input reference frequency.	[rpm]	1	R/W M
Pr54	Encoder-in rotation speed (read-only). Indicates the input reference frequency translated into rpm (based on 4096 imp/revolution).	[rpm]	0	R
Pr55	Window for servo-error 1. If the position error as an absolute value exceeds the value set in Pr55, b70.4 is set to 1. Otherwise, b 70.4 = 0.	[count]	1000	R/W M
Pr56	Window for servo-error 2. If the position error as an absolute value exceeds the value set in Pr56, b70.5 is set to 1. Otherwise, b 70.5 = 0.	[count]	100	R/W M
Pr57	Proportional gain for the position regulator.	0 ÷ 32000	100	R/W M
Pr58:59	Quota captured. The value Pr66:67 is captured on the positive edge of the selected input (see b70.0).	[count]	0	
Pr60:61	Regulator position reference.	[count]	0	R
Pr62:63	Motor position (fbk). If incremented by 4096 steps per revolution.	[count]	0	R
Pr64:65	Position offset.	[count]	0	R/W M
Pr66:67	Encoder-in counter	[count]	0	R
Pr68:69	Value captured. Value of the position of the motor captured on the positive edge of the input (IN0).	[count]	0	R
Pr96:95	value comparators (b94.8) See par. value comparators.			
Pr98:97	value comparators (b94.9). See par. value comparators			
Pr106	Feed forward scale.	0 ÷ 1000	0	R/W M
Pr154	Multiplicative factor of reference ENCODER CAN. Set the ratio of the encoder input.	-32000÷ +32000	1	R/W M
Pr155	Divisor factor of reference ENCODER CAN. Set the ratio of the encoder input.	-32000÷ +32000	1	R/W M
Pr157:156	ENCODER CAN input counter.	[steps]		
Pr158	ENCODER CAN pointer (b70.10).			
Pr159	Speed of encoder IN via CAN.			

Par.	Description	field/Unit	Def.	Type /Note
Pr212	F/Dir reference multiplier. Using this parameter and Pr213, the user can set the ratio desired for the input reference frequency.	-32000÷ +32000	1	R/W M
Pr213	F/Dir reference divider. Using this parameter and Pr212, the user can set the ratio desired for the input reference frequency.	-32000÷ +32000	1	R/W M
Pr215:214	F/Dir counter. Counter of input pulses.	[steps]		R M
Pr216	F/Dir rotation speed (read-only). Indicates the input reference frequency translated into rpm (based on 4096 imp/revolution).	[rpm]		R M

Par.	Description	Def.	Type /Note
b70.0	Encoder in capture. If = 0, the capture of the value encoder master is made from input 0. Otherwise, it is made by the input of the zero trace encoder.	0	R/W M
b70.1	Feedback. If = 0, feedback is done by the resolver. If = 1, feedback is done by the encoder. In this last case, the parameters Pr52 and Pr53 serve to rate the pulses per revolution at 4096.	0	R/W M
b70.2	Feedback direction. If = 1, the rotation of the motor is inverted. Only with feedback done by the resolver.	0	R/W M
b70.3	Output programmable on module (out1).		R/W
b70.4	Servo error. B70.4 will be set to 1 if the position error as an absolute value exceeds the value set in Pr55.	0	R
b70.5	Servo error. B70.5 will be set to 1 if the position error as an absolute value exceeds the value set in Pr56.	0	R
b70.6	Feed-forward enable. If set to 1, the feed-forward on the position regulator is enabled.	0(*)	R/W M
b70.7	Feed forward scale enable. If B70.6=1, is possible enable the feed forward scale.	0	R/W M
b70.8	Enable encoder CAN.		
b70.9	Master frequency reference Encoder in 0 – Encoder CAN 1		
b70.10	Enable ENCODER CAN pointer (Pr158).		
b70.12	(1) enable Pr152 on emgy message. Command in CANopen, it generates an user message with value in Pr153:152. Automatic reset when the message is sent.		
b70.13	Reference master Encoder CAN frequency – Reference frequency/direction IN2/IN3. Select the reference: (0) encoder CAN, (1) digital inputs IN2/IN3.	0	R/W M
b70.14	Value master captured. If set to 1, this means that the value master has been captured. The user must set the bit to 1 (no autoreset).	0	R/W M
b70.15	Value motor captured. If set to 1, this means that the value motor has been captured. The user must set the bit to 1.	0	R/W M
b180.14	Master/Motor reference captured. (0) from master reference, (1) from motor position. The value captured is in Pr59:58.	0	R/W

(*) 1 in OPM 14
0 in the other cases

7.2 Torque control (operating mode 1)

This operating mode does not control the torque in the classic way since the speed control continues to work to control the speed limit. The torque reference will be the Pr7 main reference. To set up the torque control, you must first adjust the speed control in order to establish a stable system and then set Pr31 = 1 in order to program the operating mode by setting the default values with the command b99.11. Set Pr2 = 1000 (10 V = 100.0 % of the torque), b40.0 = 0, b40.12 = 0, b40.2 = 1 to enable the reserved reference and Pr100 to limit the maximum speed of the motor.

OPERATING MODE 1 PARAMETERS

Par.	Description	Field/Unit	Def.	Type /Note
Pr100	Maximum speed. This parameter is used to limit the absolute maximum speed of the motor during the torque function.	0... 9000 [rpm]	3000	R/W M

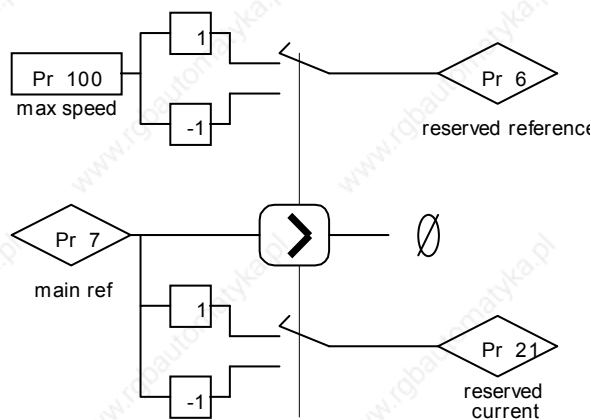

7.3 Digital Lock + Positioner (operating mode 13)

Operating mode 13 includes the Digital Lock, dynamic positioner and flow speed functions in order to use them at the same time. The tracking function refers to the input frequency signal (X3 connector) set as an input encoder signal by setting $b42.0 = 0$, $b42.1 = 1$, and $b42.5 = 1$. This encoder signal is counted at every end of the communication of A and B signals. The counter of the motor position is incremented at the rate of 4096 steps per revolution. The user can program the ratio between the master and the slave by using parameters Pr52 and Pr53. It is possible to choose the ramp to use during the engaging or release phase (Pr103). See the connection diagrams in the section, *Input frequency connection*. If you use a digital input for the engaging command, the digital input 0 in FAST-IN mode must be used in order to minimize phase errors.

The positioner function follows a trapezoidal profile in which the acceleration and deceleration ramps are defined by Pr109, the full speed by Pr108 and the final position by Pr118:119 (one revolution of the motor equals 4096 steps). The parameters can be modified at any time. The current position of the positioner is given by the parameter Pr116:117.

You can add a speed by using Pr104.

7.3.1 TAB0: profiles in memory

In OPM13 is possible use the TAB0 to memory up to 51 trapezoidal profiles, and for everyone is possible memorize the speed, the acceleration/deceleration ramp and the final position in double word.

The Pr193 parameter contains the number of the profile to execute, with $b231.10=1$ bit the function is able to transfer the block of 4 variables of profile in the positioner variables.

TAB0 1^a word – speed – Pr108

TAB0 2^a word – acc/ dec ramp – Pr109

TAB0 4^a e 5^a word – final position – Pr118:119

With the qualified function, $b231.10=1$, is possible execute automatically another profile, simply setting up in the pointer parameter, Pr193, another value. Every scansion, the parameters are transferred from the table to the positioner variables, if the function is able, $b231.10=1$.

In order to insert the values in variables of TAB0, using the “configuration” tool it is necessary open the “monitor” window, where it is possible to access from Pr2048 to Pr2302 parameter, where there are the variables of the 51 trapezoidal profiles, and it possible read and modify them.

To insert the values via keypad, it necessary selects TAB0 (T0), indicate the variable of TAB0 (from 0 to 254), and in the inferior line write the width of the parameter.

It is necessary save the parameters for guarantee the memory of the profiles inserted.

b231.10=1 TAB0 activation by profiles			
Pointer to table Pr193	TAB0 point	Positioner variables	
0	0	Pr108	Speed
	1	Pr109	Accel/Decel. ramp.
	2		
	3	Pr118	Final position
	4	Pr119	
1	5	Pr108	Speed
	6	Pr109	Accel/Decel. ramp.
	7		
	8	Pr118	Final position
	9	Pr119	
49	245	Pr108	Speed
	246	Pr109	Accel/Decel. ramp.
	247		
	248	Pr118	Final position
	249	Pr119	
50	250	Pr108	Speed
	251	Pr109	Accel/Decel. ramp.
	252		
	253	Pr118	Final position
	254	Pr119	

OPERATING MODE 13 PARAMETERS

Par.	Description	Field/Unit	Def.	Type/Note
Pr103	Acceleration and deceleration ramp (el. Axis). The acceleration and deceleration required for the motor can be limited in order to achieve a jump of 1000 rpm that takes Pr103 thousandths of a second. This can be useful when the axis is suddenly attached.	0÷30000 [s/Krpm]	0.500	R/W
Pr104	Addition speed.	±6000	0	R/W
Pr108	Full speed (positioner). This is the full speed that will be used during the generation of the position profile.	0÷9000	1000	R/W
Pr109	Acceleration time (positioner). This is the acceleration ramp that will be used during the positioning profile.	0.002÷30000 [s/Krpm]	0.5	R/W

Par.	Description	Field/Unit	Def.	Type/Note
Pr114 Pr115	Actual position (electrical shaft). Indicates the actual position with reference to the electrical shaft.	[count]		R
Pr116 Pr117	Actual position (positioner). Indicates the actual position with reference to the trapezoidal profile.	[count]		R
Pr118 Pr119	Final position (positioner). Used to set the final position that is desired for the generator of the trapezoidal profile, based on 4096 steps per revolution.	[count]		R/W
Pr193	Select profile in Tab.0.	-	0	R/W

Binary parameters OPM13

Par.	Description	Def.	Type/Note
b150.0	Active positioner. During the positioning (Pr118:119 \neq Pr116:117) this bit is high.	0	R/W M
b150.2	Engaged electrical shaft. During the engaging phase when the ramp (Pr103) is not 0, this bit indicates the end of the transitory phase.	0	R/W M
b150.3	Encoder in selection. If 0, the encoder input, conditioned by Pr52 and Pr53, is used as the master for the electrical axis function. If 1, it updates directly Pr118:119 to execute the step like function or pulses train.	0	R/W M
b150.4	Profile direction. Read-only flag. Indicates the direction of the motion of the positioner.	0	R M
b150.6	Profile feed-forward. Default=0. If 1 the profile feed-forward is disabled.	0	R/W M
b150.8	El. Axis engaging/release. This bit it used to engage (= 1) and release (= 0) the axis from the input encoder reference.	0	R/W M
b150.10	Type 1 reset. Command to set all the motor position and reference to 0.	0	R/W
b150.11	Type 2 reset. Command that sets the position of the motor shaft (Pr62:63) to the main reference (Pr60:61) and of the positioner (Pr116:117) by setting that of the electrical shaft to 0.	0	R/W
b150.13	Final position evaluation enable/disable (Pr118:119). Default = 1. If 0, eventual modifications to Pr118:119 will not be considered.	1	R/W M
b231.10	Enable profile on Tab0. b231.10=1 bit enable the profile selected.	0	R/W

OPM13

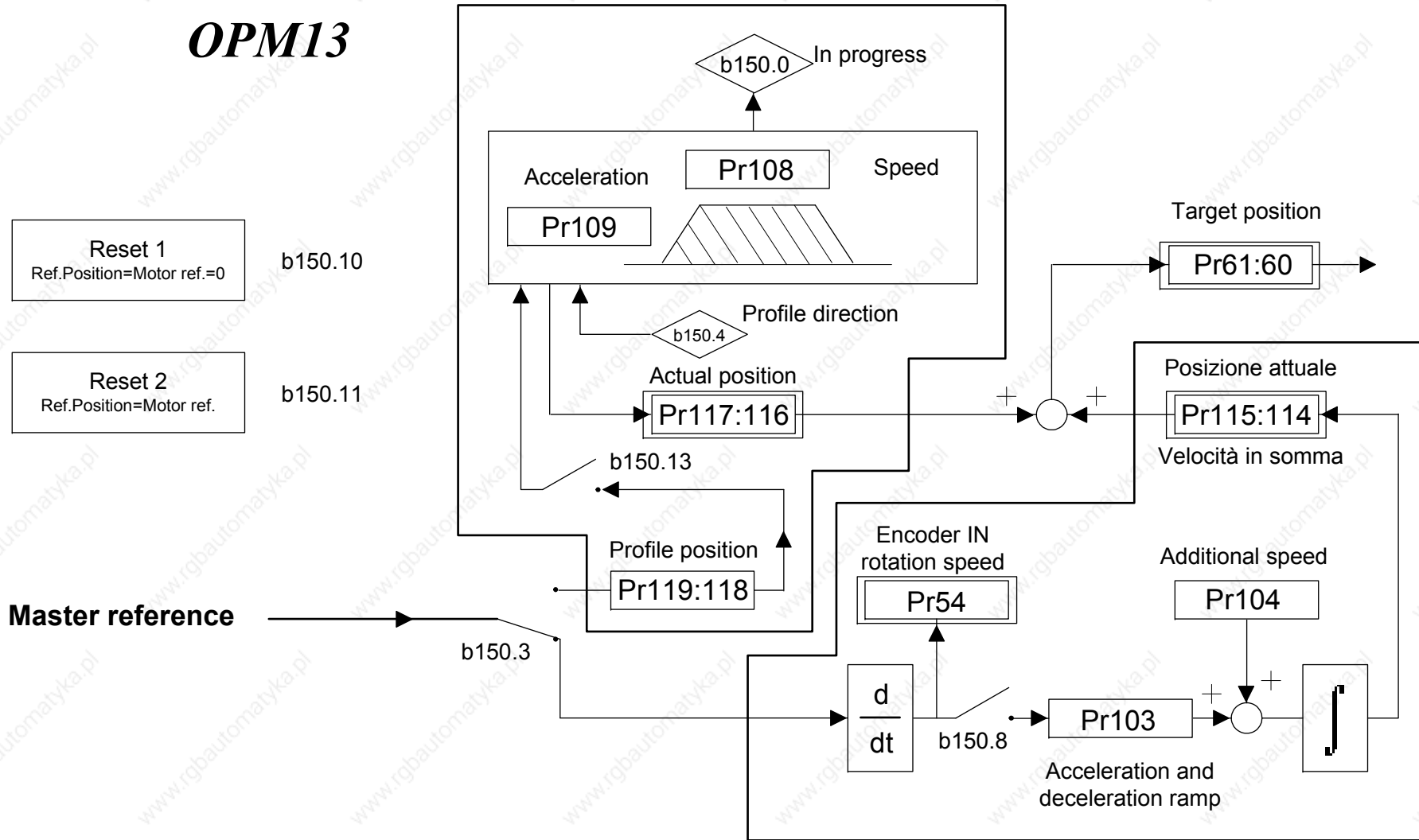

7.4 Electronic cam (operating mode 14)

Operating mode 14 is expressly designed to meet the needs of packaging machines that require electronic cams. This program is in the drive's basic configuration and it can be programmed by selecting Pr31=14 and b99.11=1, parameters to select the operating mode and to select default parameters of operating mode.

By setting b40.2 to 1, the OPM14 will be turned on, and using opportunely the mode selector Pr102, is possible select the source for the position loop. The possible sources are:

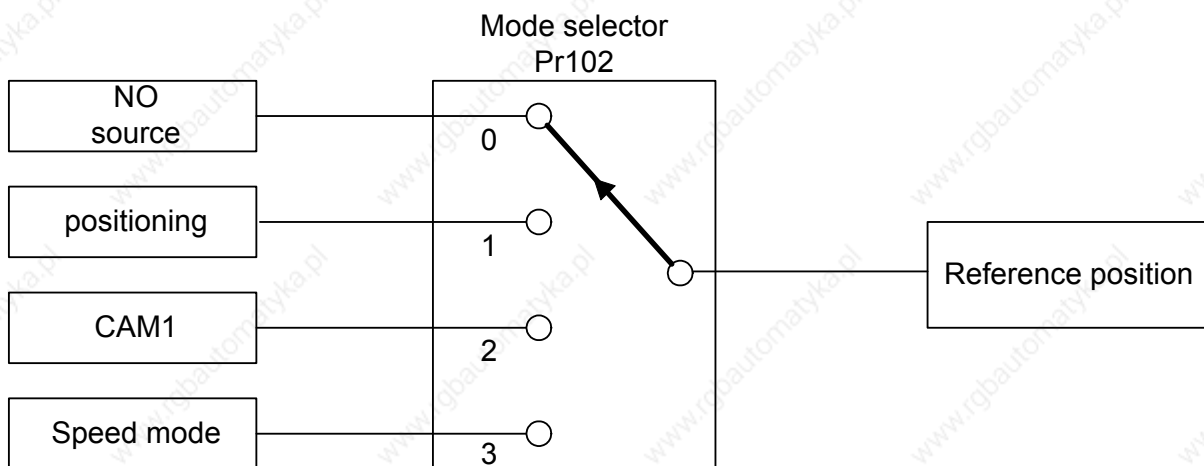

In OPM14, counters for the position loop are visualized to module (Pr60:61; Pr62:63), and the value of the module is set on the parameter Pr114:115.

7.4.1 Positioning

This is a trapezoidal profile generator, with the following user-definable parameters:

speed profile

acceleration and deceleration ramp

final value in motor step

The parameter referred to the final position is absolute. The difference between the final position (Pr119:118) and the reference position (Pr60:61), generates the direction of the movement.

The generator of the profile begins when the Pr102 is equal to 1, and when reached the position, the mode selector is automatically set to zero. Alternatively with the bit b150.3=1 (and Pr102=2), the quota written in the final position comes added algebraically with the reference of the master in the CAM1 generator. When the profile is finished, the bit b150.3 is automatically set to zero; it can be activated again if another quota is loaded in the final position (Pr119:118).

7.4.2 Speed mode

It activates with Pr102=3 and the parameters are Pr100, speed, and Pr101, acceleration and deceleration ramp.

7.4.3 Electronic cam

Four tables are available, namely TAB0, TAB1, TAB2 and TAB3, that have been implemented to perform a series of cam functions. Each table is described by a vector made of 257 elements, that indicate the position to be taken by the controlled axis when the motor axis is in the position:

$$\text{Master position} = \frac{\text{element number} \cdot \text{master modul}}{256}$$

In each table the value of the vector elements is ranging between 0 and 9999, whereas 10,000 shall be the count number set in the slave module parameter.

In order to generate a table, the axis route must be divided into 257 points; the value of each point will have to be rated to 10000, because this is the maximum value that can be written in the table elements.

The 257th element of each table defines the cam as closed if it is = 0, or as open if it is = 10,000.

The block diagram highlights that the OPM14 has only one cam generator, and it is possible to select one of four tables (Tab0, Tab1, Tab2 e Tab3). As a default OPM14, TAB0 is active.

Some functions in which execute automatic loading of the tables are predefined, and in addition there are the commands who allow the activation of the other tables in the cam generator.

The user can generate the function for every table through points construction (variable TAB); or through the motion laws predetermined in the drive in one of the four tables. Following comes illustrated like recalling the functions:

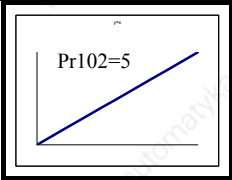
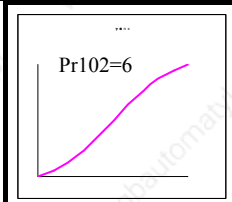
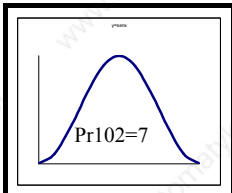
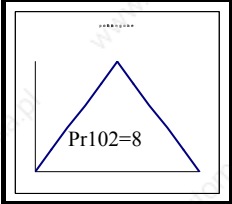
<i>Predetermined function</i>		Table
 <p>Pr102=5 function y=x</p>	 <p>Pr102=6 function y=x-senx</p>	Tab0
 <p>Pr102=7 function y=senx</p>	 <p>Pr102=8 Triangular profile of speed</p>	

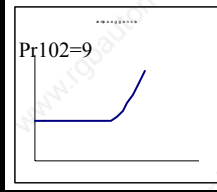
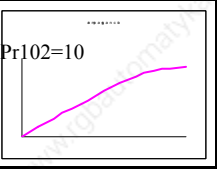
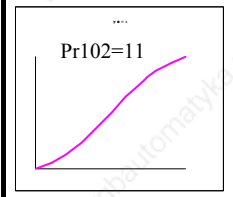
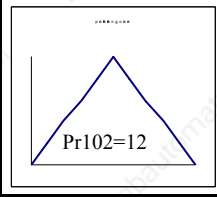
		Engage ramp	Tab1
		Disengage ramp	Tab2
	function $y=x-senx$		Tab3
<p style="text-align: center;">Pr102=14 <i>Adaptation module of CAM1 through Pr176:177 and Pr178:179</i></p>			CAM1

Pr102 can be setting through serial line, CAN or pico-PLC internal to the drive. It's not possible set this parameter using the display.

The activation of the table in the cam generator, can be given by direct command that executes immediately the selected table, or defining one phase of the master and determining the activation point. It is to cure of the customer the synchronization of the functions during the passages between the tables.

As a OPM14 default configuration, the CAM1 is scanned through the master module, using Adaptation module command (Pr102=14) the function is scanned in one sector of master module. The selected cam can be scaled in a sector of the master module by programming the starting point Pr177:176 and the space Pr179:178 in which the cam shall be executed.

The parameter values "starting point" and "space" must be included between 0 and master module in Pr111:110.

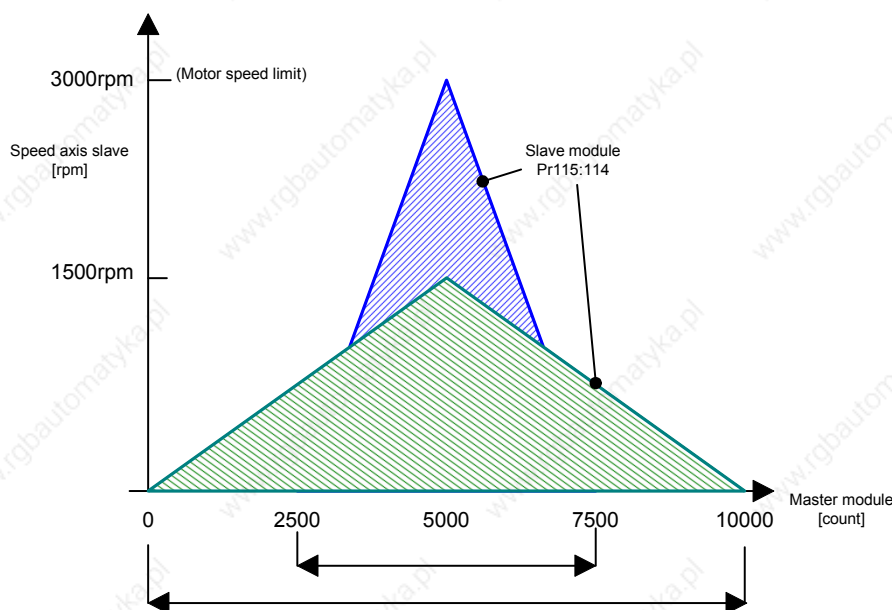

b150.12 and b150.13 command the engage and the disengage in correspondence of the master phases written in Pr127:126 and in Pr 129:128, they are always referred to master module of CAM1. If adaptation module is used, the engage/disengage phase is always referred to master module.

By setting the function (b150.8) the user can define the position of the master (Pr122:123) on the positive side of digital input 0 or of the zero trace encoder input (selector b70.0); b70.14 shows that the initialize has been achieved. The user must set this flag to 0.

The scanning of Tab3 table can be substituted with a scanning of a virtual table, if setting b181.8=1. All points in Tab3 table have the value decided in Pr105. After the execution of the commands, the bits are automatically set to zero.

All parameters that are not declared are reserved and must not be used.

OPM14 parameters

- Pr100** **Speed in speed mode.** Default = 0, range 0..±6000.
- Pr101** **Ramp time for Pr100.** Unit = s/krpm, range = 0.002..30.000, resolution = 0.001s, default=0.500 s. This is the acceleration ramp that will be used by the speed mode.
- Pr102** **Function selector.** Default=0, range 0..3. Enables the functioning as: a halted motor, positioning, electronic cam and speed.
- Pr103** **Pointer to the cam table.** Default=257, range 0..257. Pr103 is used to access the cam table. Pr104 will contain the value of the Pr103th element in the table.
- Pr104** **Table element value.** Default=0, range 0..10000. Pr104 is the value of the Pr103th element in the table.
- Pr108** **Full speed (positioner).** Unit = rpm, default=1000, range =0..+9000. This is the full speed that will be used during the generation of the position profile.
- Pr109** **Acceleration time (positioner).** Unit=s/krpm, range =0.002..30.000, resolution =0.001s, default=0.500 s. This is the acceleration ramp that will be used during the positioning profile.
- Pr110:111** **Master axis module.** Unit = steps; range 0..2¹⁸ Default=10000. This is the value of the master axis module.
- Pr112:113** **Master axis position.** Unit = steps; this is the present position of the master axis.
- Pr114:115** **Slave axis module.** Unit = steps; range 0..2¹⁸ Default=10000. This is the value of the slave axis module.
- Pr116:117** **Master position offset.** Unit=steps; range 0..2²³, default=0.
- Pr118:119** **Final position (positioner).** Unit = steps; the parameter used to set the final position desired for the generator of the trapezoidal profile, based on 4096 steps per revolution.
- Pr120:121** **Master position.**
- Pr122:123** **Master axis phase.** Unit = steps; range 0..2²³ Default=0. If b150.8 = 1 at the first positive front of digital input 0 or of the zero encoder input (see the block diagram), the position of the master axis become Pr122:123.
- Pr124:125** **Master axis phase captured.** Unit = steps; range 0..2²³ Default=0. At each positive front of digital input 0 or of the zero encoder input (see the block diagram), the position of the master axis is copied into in Pr124:125.

- Pr126:127 Master axis phase for engaging.** Unit = steps; range 0..2²³ Default=0. If b150.12 = 1, when the position of the master Pr112:113 exceeds Pr126:127, Pr102 is brought to position 2 and b150.12 returns to 0 to indicate that engaging has been achieved.
- Pr128:129 Master axis phase for release.** Unit = steps; range 0..2²³ Default=0. If b150.13=1, when the position of the master Pr112:113 exceeds Pr128:129, Pr102 is brought to position 1 and b150.13 returns to 0 to indicate that the positioner has been enabled and will control the release phase.
- Pr132:133 Engage cam with ramp.** Unit=steps; range 0..2²³, default=0. This is the position on which the engage ramp related to the master starts.
- Pr134:135 Slave cam position.** Unit=steps; range 0..2²³. Read only parameter that shows the position at the output of the cam.
- Pr136:137 Engage cam ramp.** Unit=steps; range 0..2¹⁵, default=0. This is the step value performed by the slave during the engage ramp; the value must be less than an half of the slave axis module.
- Pr154 Multiplicative factor of reference ENCODER CAN.**
- Pr155 Divisor factor of reference ENCODER CAN.**
- Pr157:156 ENCODER CAN input counter.**
- Pr158 ENCODER CAN pointer (b70.10).**
- Pr169:168 Master phase for engaging of Tab.0 (b180.0).**
- Pr171:170 Master phase for engaging of Tab.1 (b180.1).**
- Pr173:172 Master phase for engaging of Tab.2(b180.2).**
- Pr175:174 Master phase for engaging of Tab.3 (b180.3).**
- Pr177:176 Scale CAM (start cam).**
- Pr179:178 Scale CAM (Space cam).**
- Pr185:184 Change of the value slave axis module in phase**
- Pr212 Multiplicative factor of reference Frequency/Direction.**
- Pr213 Divisor factor of reference Frequency/Direction.**
- Pr215:214 Input counter Frequency/Direction.**
- Pr216 Rotation speed input Frequency/Direction.**

Binary parameters

- b150.2 Position loop.** Default=0. If = 1 the position loop works on absolute positions, otherwise on slave axis module.
- b150.3 Master phase-shift command.** Default=0. If = 1, the positioner module is used to change the phase between the master and the slave or as the generator of the virtual axis. When the final position Pr118:119 equals Pr116:117, this bit is automatically set to 0. Do not use this command together with Pr102=1.
- b150.6 Encoder input enable (X3).** Default=1. If = 1, the reading of the encoder master is enabled.
- b150.8 Phase master axis enable.** Default=0. If = 1, the copying of parameter Pr122:123 to Pr112:113 to the first front of the rise of input 0 or the zero encoder is enabled.
- b150.10 Type 1 reset.** Command to set all the motor positions and references to 0.
- b150.11 Cam engaging in phase with ramp.** Command to engage the cam movement when the master reaches the level of Pr126:127 with a ramp defined by the parameters Pr132:133 and Pr136:137.
- b150.12 Electronic cam engaging in phase.** Command to engage the cam movement when the master reaches the level of Pr126:127. This bit is automatically set to 0 when the command has been enabled.
- b150.13 Electronic cam release in phase.** Command to release the cam movement when the master reaches the level of Pr128:129. This bit is automatically set to

- 0 when the command has been enabled.
- b150.14 Immediate electronic cam engaging.** Command to engage the cam movement. This bit is automatically set to 0 when the command has been enabled.
- b150.15 Immediate electronic cam release.** Command to release the cam movement. This bit is automatically set to 0 when the command has been enabled.
- b180.0 Start Tab0 on master phase of Pr168:169.** =1 activates the Tab0 table to the specified phase master in Pr168:169. The values of the parameters for the activation on specific phase must be comprised between 0 and the written module master in Pr110:111.
- b180.1 Start Tab1 on master phase of Pr170:171.** =1 activates the Tab1 table to the specified phase master in Pr170:171. The values of the parameters for the activation on specific phase must be comprised between 0 and the written module master in Pr110:111.
- b180.2 Start Tab2 on master phase of Pr172:173.** =1 activates the Tab2 table to the specified phase master in Pr172:173. The values of the parameters for the activation on specific phase must be comprised between 0 and the written module master in Pr110:111.
- b180.3 Start Tab3 on master phase of Pr174:175.** =1 activates the Tab3 table to the specified phase master in Pr174:175. The values of the parameters for the activation on specific phase must be comprised between 0 and the written module master in Pr110:111.
- b180.4 Start Tab.0.** Immediate activation of Tab0. Show table activate in CAM1 generator.
- b180.5 Start Tab.1.** Immediate activation of Tab1. Show table activate in CAM1 generator.
- b180.6 Start Tab.2.** Immediate activation of Tab2. Show table activate in CAM1 generator.
- b180.7 Start Tab.3.** Immediate activation of Tab3. Show table activate in CAM1 generator.
- b180.14 (0)Cought quota master frequency input (1) Cought quota Motor position-Storage in Pr58:59**
- b181.0 Enabled Tab.0 in the Cam.** =1 Tab0 activates.
- b181.1 Enabled Tab.1 in the Cam.** =1 Tab0 activates.
- b181.2 Enabled Tab.2 in the Cam.** =1 Tab0 activates.
- b181.3 Enabled Tab.3 in the Cam.** =1 Tab0 activates.
- b181.8 Enable virtual table (Tab.3).**
- b181.12 Activation change value of the slave module in phase.**

OPM14

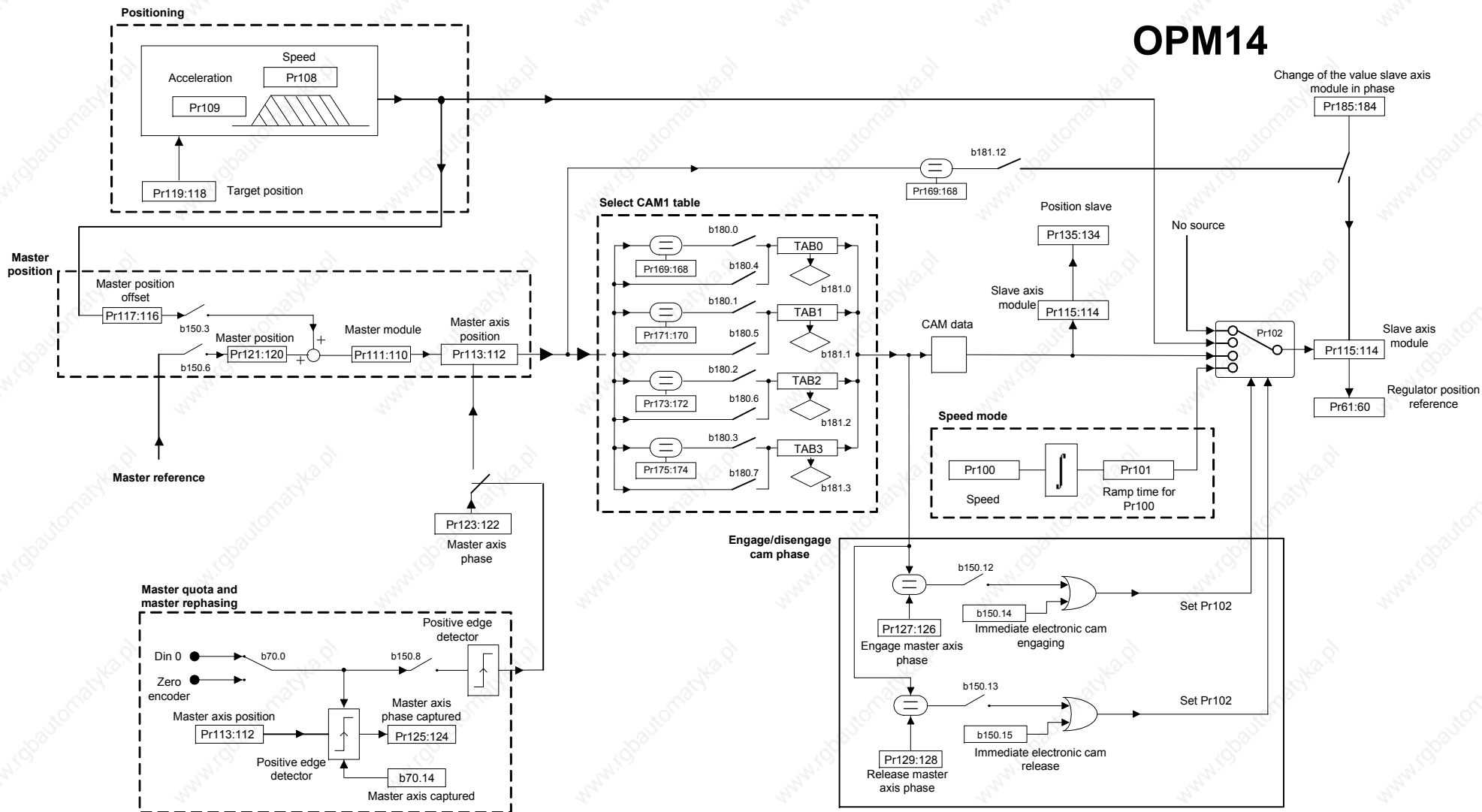

7.4.4 OPM 14 Linear engage CAM

With OPM14 exists the possibility to program a linear engage cam on master module.

It's necessary to define the space to use of the module master in which executing the engage cam of the slave. Program the Pr132:133 parameter like start point and the Pr126:127 parameter like final point; setting the bit b150.11 reserves the start of the slave in the start point of the module master programmed. It is necessary that in this point the value of Pr134:135 is equal to the position caught from the slave to end of the ramp, that is to start of the ramp the slave must be found in advance regarding the engage point in phase with equal distance to Pr136:137. The bit b150.11 is automatically set to zero after the engage.

In the final point of the engage cam, automatically is activated the cam table wrote in the drive. The event is marked with the bit b150.12=1 (to the start of the ramp); after the activation of the table the b150.12 is automatically set to zero.

As to the engage phase needs to define one internal point to the master module for the start of the disengage ramp.

To difference of the engage cam executed, the disengage phase is a simply deceleration ramp and comes executed through the positioning of the OPM14.

The release point is written in the Pr128:129 parameter (in step module master). Activating bit b150.13 reserves the start of disengage of the slave in the point programmed; the bit b150.13 is automatically set to zero after the disengage. Activated the disengage phase on the programmed point it is necessary to define the point of stop in which stopping the slave (in step module slave); this point of stop is written in the Pr118:119 parameter (in step module slave).

This space must be sufficient to permit to stop the axis with the deceleration ramp programmed on the Pr109; in the start point in Pr128:129 and the final position point in Pr118:119 are too much near (pay attention to master/slave module conversion), is necessary to add to the final position one or more slave modules: Pr118:119 (slave module) + final position internal at the slave module.

The compilation of the cam table is made in background and at the conclusion Pr102 is automatically set to zero; pay attention that if b40.2=0 the Pr102 parameter comes forced however to zero.

Moreover there are two conditions for a corrected operation of this engage cam:

1. The final point of the disengage ramp is not accidentally chosen in the module slave, but direct consequence of the chosen space of the engage cam. The slave axis must be situated in advance regarding the position of Pr134:135 (when the master is in Pr126:127 position) of the quota:

$$\text{Advance quote} = \frac{(\text{Pr127:126} - \text{Pr133:132}) \cdot \text{Pr115:114}}{2 \cdot \text{Pr111:110}} = \text{Pr137:136}$$

2. The speed in the points of passage between cam and deceleration ramp must be concord. (Pr108= cam speed)

Cam table engage automatic b150.12=1 (autoreset after engage and autoreset after engage to the drive's TAB)

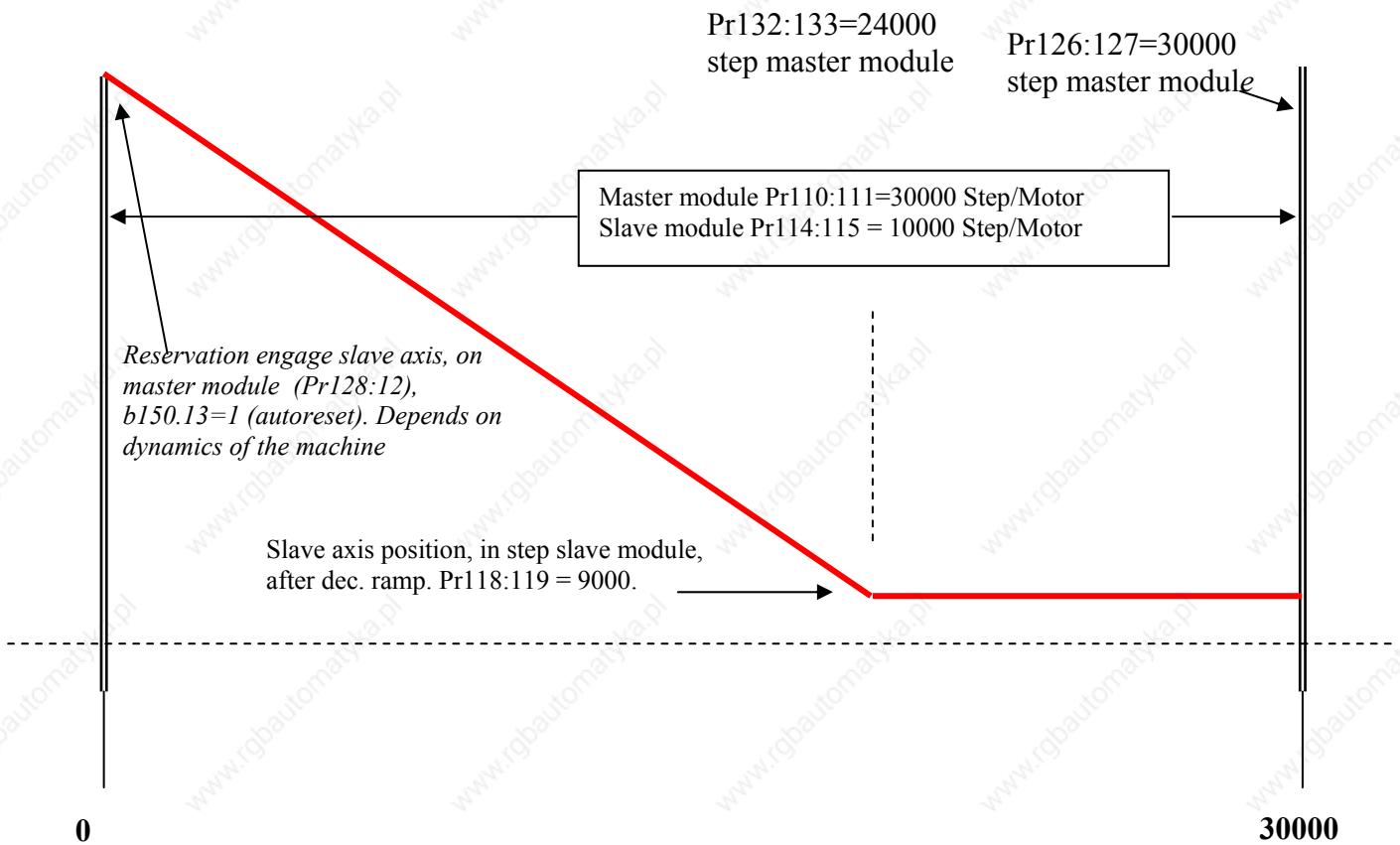
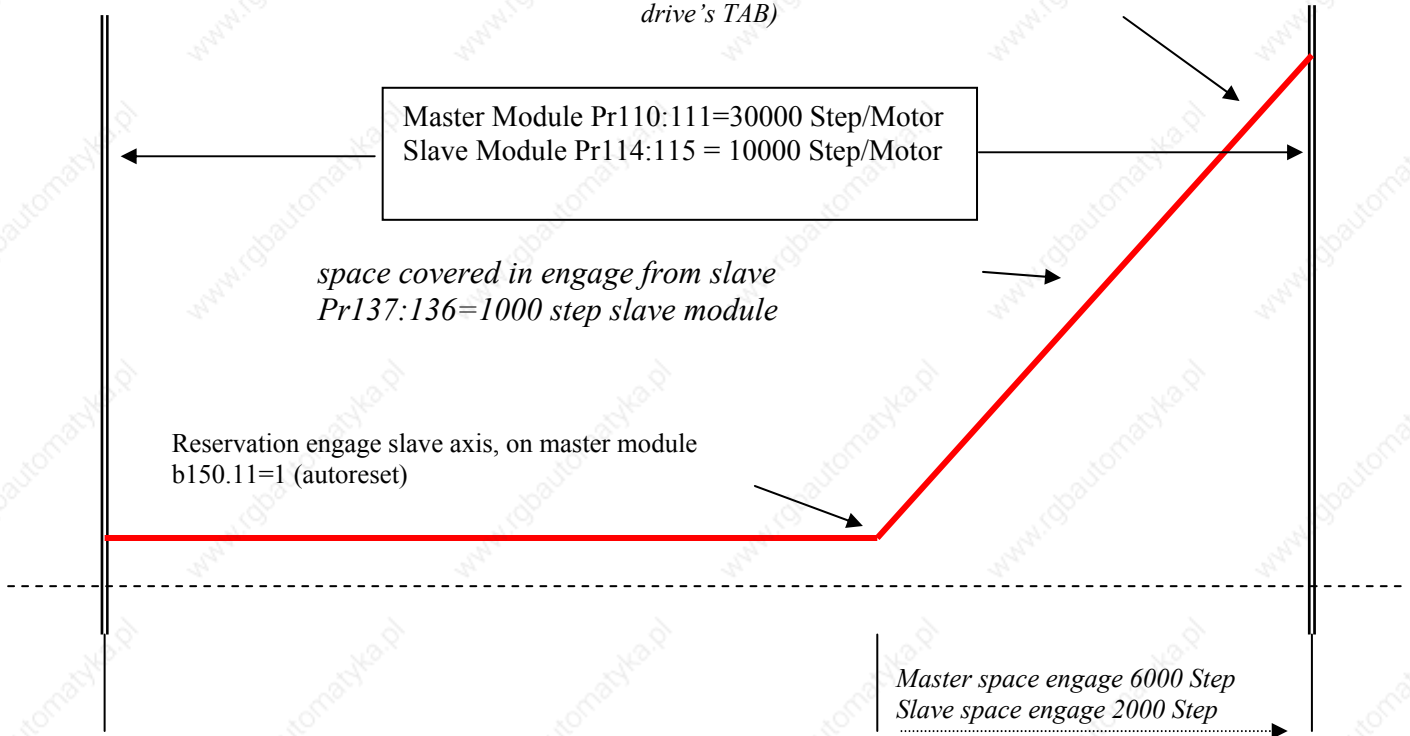

7.5 Electronic cam (op. mod. 11)

Operating mode 11 is expressly designed to meet the needs of packaging machines that require 2 electronic cams. This program is in the drive's basic configuration and it can be programmed by selecting Pr31=14 and b99.11=1, parameters to select the operating mode and to select default parameters of operating mode.

Some of the most widely used motion functions of industrial automation are available within this mode. Namely, this operating mode includes the following:

- **position reference generator (positioner)**
- **speed mode generator**
- **cam1 generator**
- **cam2 generator**

The resulting position reference is incremental and is generated by algebraic sum of the references (see the following picture).

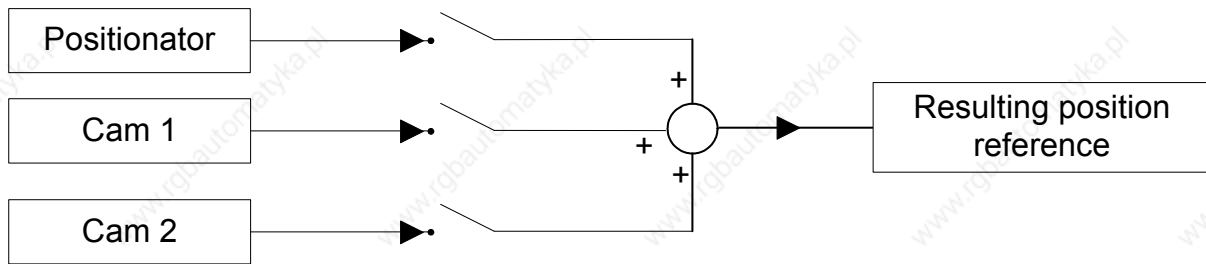

This diagram allows to identify a general flow in operating mode 11. If you carefully analyze this mode, you will see that the programmer can use several enabling commands (programmable bits) at different levels in order to address the flow of the generated position reference (or references), in several display modes. For instance, for each generator a position reference can be enabled in the position loop or into a general position counter.

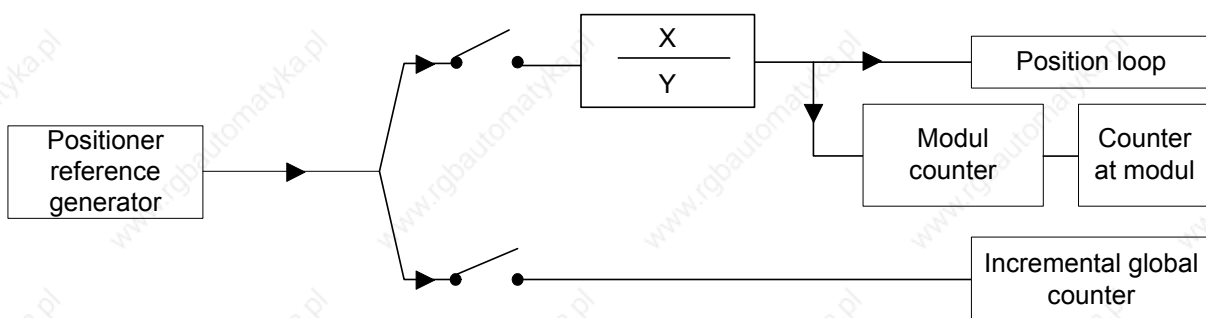

When the position reference of at least one generator is enabled in the position loop, the reference loading into a global counter defined by module is automatically enabled.

7.5.1 Positionator

This is a trapezoidal profile generator, with the following user-definable parameters:

speed profile

acceleration and deceleration ramp

value target position in motor step

The parameter referred to the target position is absolute. The difference between the target position and the reference position, generates the direction of the movement.

The thus position reference generated in this way is loaded into the position loop by b181.15=0 command, and moreover is possible to unload the reference of the positioning to the inside of the cam generators through algebraic sum with the reference of the master, with the selection command b150.3.

Pay attention if both commands (b150.3=1 and b181.15=0), because the reference of the positioning is used two times:

algebraic sum to the reference of the master in input to two generators CAM1 and CAM2, and sum in output to the references of CAM1 and CAM2.

Activating the command b181.10=1 is possible to unload the reference generated from the positioning in the global counter position (Pr131:130).

7.5.2 CAM1 and CAM2

The two CAM generators are specifically designed to meet the requirements of automatic machines using electronic cams. Four tables are available, namely TAB0, TAB1, TAB2 and TAB3, that have been implemented to perform a series of cam functions. A vector made of 257 elements describes each table, that indicate the position to be taken by the controlled axis when the motor axis is in the position:

$$\text{Master position} = \frac{\text{element number} \bullet \text{master modul}}{256}$$

In each table the value of the vector elements is ranging between 0 and 9999, whereas 10,000 shall be the count number set in the slave module parameter.

In order to generate a table, the axis route must be divided into 256 points; the value of each point will have to be rated to 10000, because this is the maximum value that can be written in the table elements.

The 257th element of each table defines the cam as closed if it is = 0, or as open if it is = 10,000.

The cams will be able to perform the points listed in the table; if the required speed and torque are within the motor's electric limits (Maximum Speed and Torque).

Through a series of parameters it is possible to automatically program one of the motion laws that have been set in the drive in one of the four tables. Functions can be retrieved as follows:

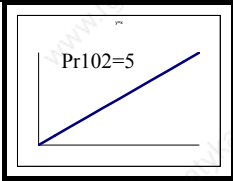
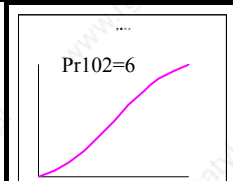
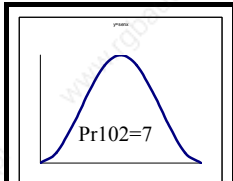
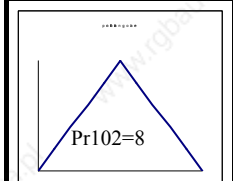
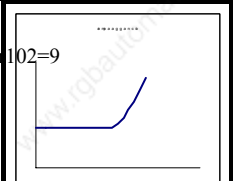
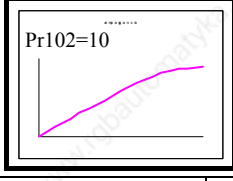
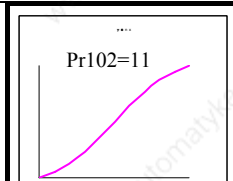
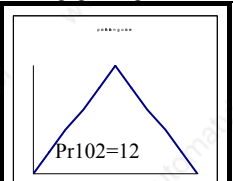
Predetermined function		Table
 <p>Pr102=5 Function $y=x$</p>	 <p>Pr102=6 Function $y=x-sinx$</p>	Tab0
 <p>Pr102=7 Function $y=sinx$</p>	 <p>Pr102=8 Triangular profile of speed</p>	
 <p>Pr102=9 Engage ramp</p>		Tab1
 <p>Pr102=10 Disengage ramp</p>		Tab2
 <p>Pr102=11 Function $y=x-sinx$</p>	 <p>Pr102=12 Triangular profile of speed</p>	Tab3
Pr102=13 Adaptation module of CAM1 through Pr176:177 and Pr178:179		CAM2
Pr102=14 Adaptation module of CAM1 through Pr176:177 and Pr178:179		CAM1

After selecting the function by Pr182, the parameter is automatically set to zero.

The four tables are the same in both CAM generators; the same table with the same function can be selected in both generators.

As a default drive configuration, TAB0 is active in CAM1 and TAB3 is active in CAM2. In order to change the default setting there are some immediate commands active for both CAM generators, or for CAM1 only of the enable commands on programmable master phase (see the OPM11 block diagram). The qualifications given from the parameters b181.9, b181.10 and b181.11, determine the algebraic sum of the references generated into the counter reference Pr131:130. This counter beyond visualizing the sum given from the references, can be employed in order to supply to Encoder CAN marks them whose increments are generate to you from a single generator, without to influence on the reference of position of the axis, being generated therefore a commanded virtual axis through the qualified reference.

When the selected table is changed, the two generators will have a different behaviour.

Based on the executed command, CAM1 immediately activates the execution of the selected table as well as a change of module. The selection of engage/disengage of the CAM1 happens in correspondence of the master phases. The b180.9, beyond signaling the state of

engage/disengage of the CAM1, it allows an engage/disengage immediate of the same without to consider the master phase. Modules with negative sign cannot be set in CAM1.

CAM2 will be engaged and disengaged only by command and always when the master is in phase 0, or by a single execution command (Single Shoot). The b180.12, beyond signaling the state of engage/disengage of the CAM2, it allows an engage/disengage immediate of the same without to consider the master phase. The user will have to check the synchronization of the new cam.

A module with negative sign can be set in CAM2 (Pr185:184). With b180.8=0 command, the CAM2 variation, table and module, is calculated immediately without the engage/disengage commands of the cam. If the b180.8=1 command, the table and the module set up in CAM2 are updated through an engage command (b180.10 or b180.13 single shot).

The user will have to check the continuity of speed and ramp during table and module changes and, especially, during the engage phase immediate.

As a default configuration, the cams are scanned throughout the master module. In both masters the selected cams can be scaled in a sector of the master module by programming the starting point and the space in which the cam shall be executed. It is possible of course to scan the cam in this way also between two master modules.

Example 1

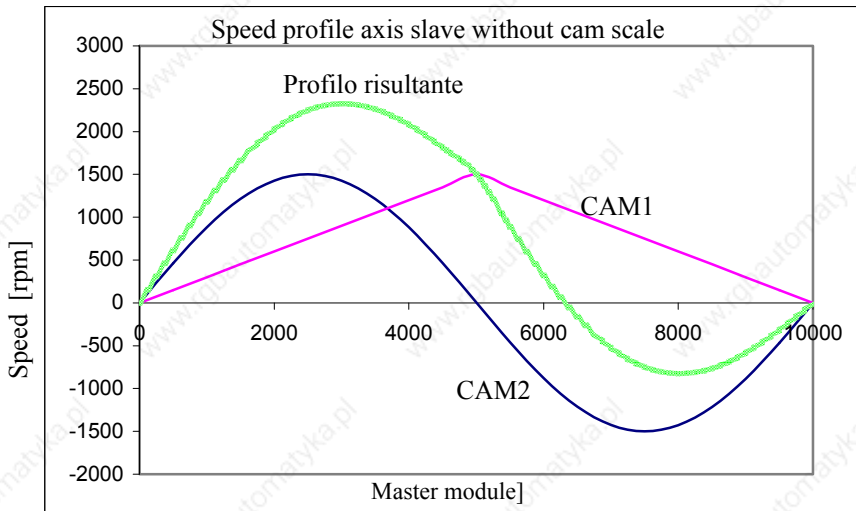

Scale CAM1:
 Pr115:114=10000 module
 Pr177:176=00 start point
 Pr179:178=10000 execution space

Scale CAM2:
 Pr185:184=10000 module
 Pr177:176=0 start point
 Pr179:178=10000 execution space

Scale status of the OPM11 default of cam

Example 2

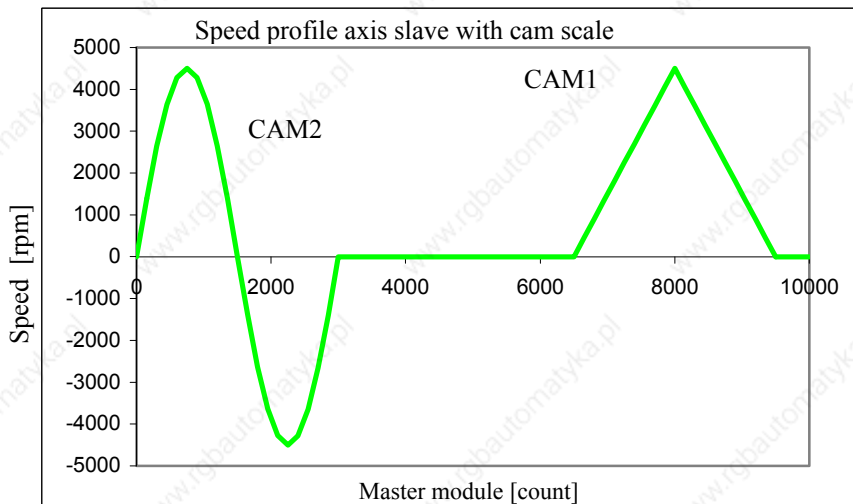

Scale CAM1:
 Pr115:114=10000 module
 Pr177:176=6500 start point
 Pr179:178=9500 execution space
 Pr102=14 calculation scale command

Scale CAM2:
 Pr185:184=10000 module
 Pr177:176=0 start point
 Pr179:178=3000 execution space
 Pr102=13 calculation scale command

After the default of operating mode, the CAM2 generator operates on table 3, but through the management of bit b182.6 and b181.7, is possible to change the reference table.

The reference of position given from the algebraic sum of the three generators, pass through a ratio block that, Pr182 and Pr183, before being transmitted to the loop of position.

7.5.2.1 Automatic activation of CAM tables

Beside enabling tables on programmable master phase or by immediate command as shown above, the drive offers a default function providing for an automatic sequence to enable the tables in order to concur some functionalities like engage and disengage cam, with connection tables.

The operation is enabled through the activation of bit b180.15=1 and by using bit 181.4 command in order to start sequence Tab0 and bit 231.14 command in order to start per a disengaging sequence. The switch between active tables always occurs during master phase 0. Tab1 and Tab2 are used as a link during the switch between Tab0 and Tab3 and the other way round, and therefore they cannot be active longer than one master module.

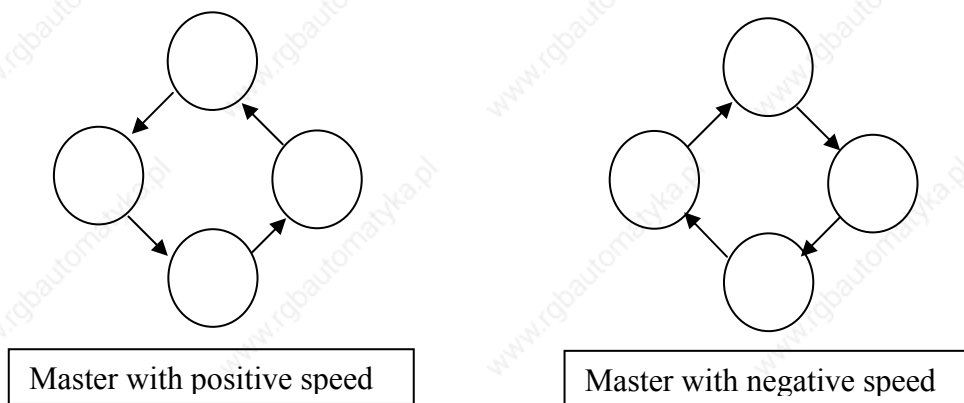

As shown in the figures, the table switching sequence is automatically inverted when the speed is negative.

The above-described function is essential, for instance, in applications where the user wants to complete an engage/disengage phase starting from a gearing function (Electrical axis) by means of linear linking ramps.

By linear links we mean the tables describing the two engage and disengage ramps. Let's suppose that Tab0 has been programmed with a $y=x$ function (gearing) and that Tab3 has been programmed as a fixed axis, that is $y=\text{constant } K$. We will need to calculate both linking tables in Tab1 and Tab2 to be able to engage and disengage the axis.

If we consider, for instance, the master cycle in a module in degrees (360°), we will have to set in Pr105 the master module sector value (ranging between 0° and 360°) that we are going to use in order to perform the two engaging and disengaging ramps.

Using the Pr102 parameter and the predefined functions that already they previewed the two tables is possible to calculate the engage in Tab1 with Pr102=9 and the disengage in Tab2 with Pr102=10.

Through the commands of the functions predefined is always estimated the function of Gearing ($Y=X$) in Tab0 with Pr102=5. The Tab3 can be replaced in this application with one fictitious table qualifying the bit b181.8=1, setting up the constant of the table in Pr105. It's possible to extrapolate in this application the constant of Pr105; reading the first value of the table of Tab1 engage in Pr104 with Pr103=1256.

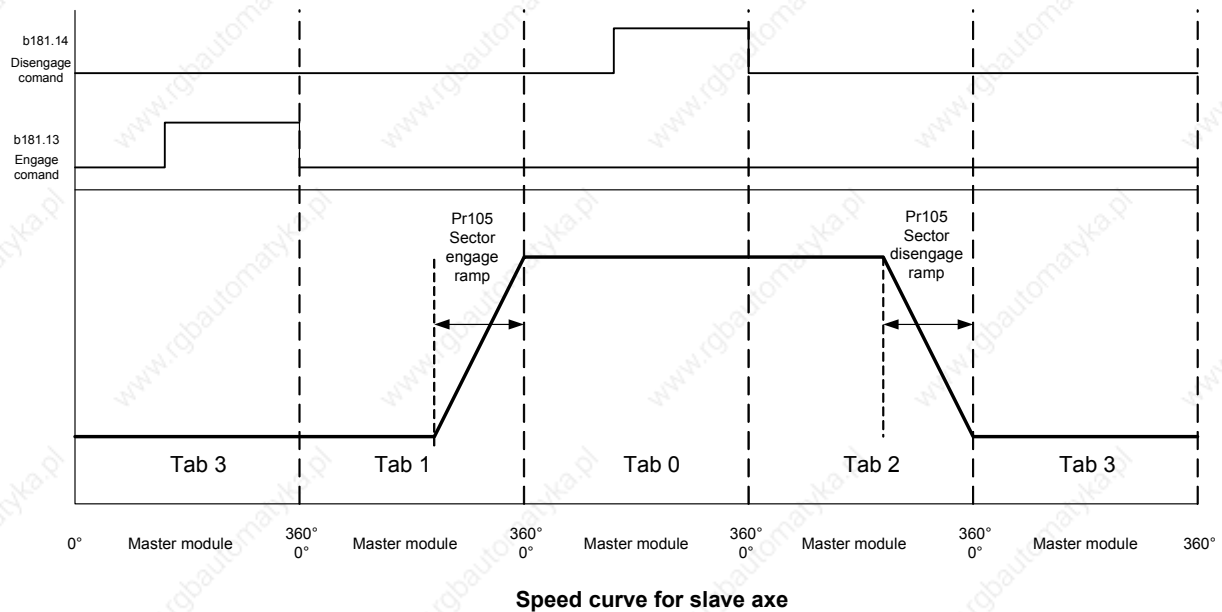

The above described tables are of course an example case to describe the engage and disengage functions of an axis by changing tables, and they are calculated in order to allow these functions for an axis that needs to be dynamically disengaged/engaged according to a gearing law ($Pr102=5 _ Y=5$).

Of course it is possible to describe different tables for similar functions and load them in the relevant array.

In order to accomplish this and more generally to ensure user access to cam tables, as it happened previously for Tab0, these can be either read and written using the keypad, or pico-PLC by pointer Pr103 and value in Pr104, or through SBC CAN, or serial port RS422 using address 4096 (adjacent areas of 257 words per table):

Keypad

Tab.0: $0 \leq Pr103 \leq 256$;
 Tab.1: $500 \leq Pr103 \leq 756$;
 Tab.2: $1000 \leq Pr103 \leq 1256$;
 Tab.3: $1500 \leq Pr103 \leq 1756$;

SBC CAN o serial

$4096 \leq \text{address} \leq (4096+513)$;
 $(4096+514) \leq \text{address} \leq (4096+1027)$;
 $4096+1028 \leq \text{address} \leq (4096+1541)$;
 $(4096+1542) \leq \text{address} \leq (4096+2055)$;

With CANopen version you can use the tables by SDO as follow:

CANopen

Tab.0: Point 0...254	Index 0x2004	Sub-index 1...255
Point 255...256	Index 0x2005	Sub-index 1...2
Tab.1: Point 0...254	Index 0x2006	Sub-index 1...255
Point 255...256	Index 0x2007	Sub-index 1...2
Tab.2: Point 0...254	Index 0x2008	Sub-index 1...255
Point 255...256	Index 0x2009	Sub-index 1...2
Tab.3: Point 0...254	Index 0x200A	Sub-index 1...255
Point 255...256	Index 0x200B	Sub-index 1...2

Decimal parameters

- Pr101:100 Reference module position (addition as module of POS+CAM1+CAM2).**
Default=0.
- Pr102 Function selector.** The value indicates one predetermined function (see the *predetermined function* table). Once that the command has been given, the table comes generated with the selected function. It is an autoreset parameter.
- Pr103 Pointer to the cam table.** Default=257, range 0...257. Through Pr103 it is possible to approach the table cam. Pr104 will contain the value of the Pr103' element of the table.
- Pr104 Table element value.** Default=0, range 0...10000. Pr 104 is the value of Pr103' element of the table.
- Pr105 Value virtual table(b181.8) - Value in degree to engage/ disengage axis.**
- Pr106 Feed-forward scale.**
- Pr108 Regime speed (positioner).** Unit=rpm, default=1000, range=0...+9000. Is the regime speed used during the generation of the position profile.
- Pr109 Speed-up time (positioner).** Unit=s/krpm, default=0.500s, range=0.002...30.000, resolution=0.001s. Acceleration ramp used during the generation of the position profile.
- Pr111:110 Master axis module.** Unit=count (steps), range 0... 2^{18} , default=10000. Module axis master.
- Pr113:112 Master axis position.** Unit=count (steps), master axis position.
- Pr115:114 Slave axis module.** Unit=count (steps), range 0... 2^{18} , default=10000. Module axis slave.
- Pr117:116 Master axis position offset.** Unit=count (steps), range 0... 2^{23} , default=0.
- Pr119:118 Target position (positioner).** Unit=count (steps), parameter in which setting up the final position for the generator of trapezoidal profile, considering 4096 steps to the turn.
- Pr121:120 Master position.**
- Pr123:122 Master axis phase.** Unit=count (steps), range 0... 2^{23} , default=0. If b150.8=1, at first positive edge of 0 digital input or at zero encoder input (see block diagram) the position of master axe becomes Pr123:122.
- Pr125:124 Master axis phase caught.** Unit=count (steps), range 0... 2^{23} , default=0. At every positive edge of 0 digital input or at zero encoder input (see block diagram) the position of master axe becomes Pr125:124.
- Pr127:126 Master axis engage phase.** Unit=count (steps), range 0... 2^{23} , default=0. If b150.12=1, when master position, Pr113:112 exceeds Pr127:126 Pr102 is brought in position 2 and b150.12 returns 0 to indicate the engage.
- Pr129:128 Master axis disengage phase.** Unit=count (steps), range 0... 2^{23} , default=0. If b150.13=1, when master position, Pr113:112 exceeds Pr129:128 Pr102 is brought in position 1 and b150.13 returns 0 to indicate that the positioner is enabled and which will control the disengage phase.
- Pr131:130 Auxiliary incremental counter of POS, CAM1 and CAM2 reference.**
- Pr133:132 Cam engage with ramp.** Unit=count (steps), range 0... 2^{23} , default=0. Start point of the engage ramp according to the master position.
- Pr135:134 Slave position from cam.** Unit=count (steps), range 0... 2^{23} . Only read and indicates the axe slave position in output to electronic cam, independent from selector Pr102.
- Pr137:136 Cam engage ramp.** Unit=count (steps), range 0... 2^{15} , default=0. Defines the space to cover during the engage ramp in slave steps; the value must be however smaller of half of slave module.

- Pr154** **Multiplicative factor of reference ENCODER CAN.**
- Pr155** **Divisor factor of reference ENCODER CAN**
- Pr157:156** **Encoder CAN counter. .**
- Pr158** **Encoder CAN pointer (b70.10).**
- Pr169:168** **Master phase for engaging of the Tab.0 (b180.0).** When the master phase matches the programmed value, then the slave engages to the master. TAB0 is enabled.
- Pr171:170** **Master phase for engaging of the Tab.1 (b180.1).** When the master phase matches the programmed value, then the slave engages to the master. TAB1 is enabled.
- Pr173:172** **Master phase for engaging of the Tab.2 (b180.2).** When the master phase matches the programmed value, then the slave engages to the master. TAB2 is enabled.
- Pr175:174** **Master phase for engaging of the Tab.3 (b180.3).** When the master phase matches the programmed value, then the slave engages to the master. TAB3 is enabled.
- Pr177:176** **Scale CAM (start cam).** If is enabled, when CAM1 arrives in this position in its module, then starts the engage of CAM1.
- Pr179:178** **Scale CAM (Space cam)**
- Pr182** **Multiplicative factor of reference sum between POS,CAM1 e CAM2.**
- Pr183** **Divisor factor of reference sum between POS,CAM1 e CAM2.**
- Pr185:184** **CAM2 axis module.**

Decimal parameters.

- b150.2** **Position loop.** Default=0. If =1 the position loop is absolute value, otherwise is in slave module.
- b150.3** **Command phase shift master.** Default=0. If =1 positioner module comes used in order to modify the phase between master and slave or like generator of virtual axis. When the final position Pr118:119 is equal to Pr116:117 this bit reset automatically. Not use this command and Pr102=1 at the same time.
- b150.6** **Enable encoder input (X3).** Default=1. If =1 enable the read of master encoder.
- b150.8** **Enable master axis phase.** Default=0. If =1 enable the copy of the parameter Pr123:122 on Pr113:112 at the first edge of input 0 or at zero encoder.
- b150.10** **Type-1 reset.** Reset command for motor positions and reference.
- b150.11** **Electronic cam engage with linear ramp.** Engage command for cam mode when the master arrives to Pr127:126 value with a linear ramp defined in Pr133:132 and Pr137:136.
- b150.12** **In-phase electronic cam engage.** Engage command for cam mode when the master arrives to Pr127:126 value, terminated the command the bit reset automatically.
- b150.13** **In-phase electronic cam disengages.** Disengage command for cam mode when the master arrives to Pr129:128 value, terminated the command the bit reset automatically.
- b150.14** **Immediate electronic cam engagé.** Engage command for cam mode; terminated the command the bit reset automatically.
- b150.15** **Immediate electronic cam disengage.** Disengage command for cam mode; terminated the command the bit reset automatically.
- b180.0** **Start Tab.0 on master phase of Pr168:169.** =1 enables Tab0 at the master phase declared in Pr169:168. The parameter values to start on master phase must be between 0 and Pr111:110 master module.

- b180.1 Start Tab.1 on master phase of Pr170:171.** =1 enables Tab0 at the master phase declared in Pr171:170. The parameter values to start on master phase must be between 0 and Pr111:110 master module.
- b180.2 Start Tab.2 on master phase of Pr172:173.** =1 enables Tab0 at the master phase declared in Pr173:172. The parameter values to start on master phase must be between 0 and Pr111:110 master module.
- b180.3 Start Tab.3 on master phase of Pr174:175.** =1 enables Tab0 at the master phase declared in Pr175:174. The parameter values to start on master phase must be between 0 and Pr111:110 master module.
- b180.4 Immediate start Tab.0.** =1, TAB0 immediate activation. Indication of which table is active in CAM1 generator.
- b180.5 Immediate start Tab.1.** =1, TAB1 immediate activation. Indication of which table is active in CAM1 generator.
- b180.6 Immediate start Tab.2.** =1, TAB2 immediate activation. Indication of which table is active in CAM1 generator.
- b180.7 Immediate start Tab.3.** =1, TAB3 immediate activation. Indication of which table is active in CAM1 generator.
- b180.8 (0)Upgrade automatically to CAM1-(1)Upgrade CAM1 only on engag  (b180.10 or b180.13).**
- b180.9 CAM 1 engaging immediatly (Signal lock/Unlock CAM 1).**
- b180.10 Electronic CAM2 engaging on master phase 0.**
- b180.11 Electronic CAM2 release on master phase 0.**
- b180.12 CAM 2 engaging immediatly (Signal lock/Unlock CAM 2).**
- b180.13 Electronic CAM2 execution on single shot.**
- b180.14 (0)Cought quota master frequency input (1) Cought quota Motor position-Storage in Pr58:59.**
- b180.15 Enable swap table (engage/releaselinear).**
- b181.0 Enabled Tab.0 in the Cam.** =1 TAB0 is enabled.
- b181.1 Enabled Tab.1 in the Cam.** =1 TAB1 is enabled.
- b181.2 Enabled Tab.2 in the Cam.** =1 TAB2 is enabled.
- b181.3 Enabled Tab.3 in the Cam.** =1 TAB3 is enabled.
- b181.4 Command swap of Tab.0 (Tab.0-Tab1-Tab.3).** The switching between the tables is showed in the picture.
The switching starts from TAB0 to TAB3, counterclockwise direction.
- b181.5 Command swap of Tab.3 (Tab.3-Tab2-Tab.0).** The switching between the tables is showed in the picture.
The switching starts from TAB3 to TAB0, clockwise direction.
- b181.6 Selection Table in the CAM 2.** The state of this bit, together with bit b181.7, identifies the selected table (see table below*).
- b181.7 Selection Table in the CAM 2.** The state of this bit, together with bit b181.6, identifies the selected table (see table below*).

* Table selection	b181.6	b181.7
Tab0	1	1
Tab1	1	0
Tab2	0	1
Tab3	0	0

- b181.8 Enable virtual table (Tab.3).**

- b181.9 Enable counter position from CAM1 to global counter(Pr130:131).** This command, b181.9=1, enable the reference of CAM1. This value is added algebraically to global counter of reference.
- b181.10 Enable counter position from CAM 2 to global counter(Pr130:131).** This command, b181.9=1, enable the reference of positioner. This value is added algebraically to global counter of reference.
- b181.11 Enable counter position from trapezoidal positioner to global counter (Pr130:131).** This command, b181.9=1, enable the reference of CAM2. This value is added algebraically to global counter of reference.
- b181.13 Enable counter position from CAM 1 to reference position (Pr60:61).**
- b181.14 Enable counter position from CAM 2 to reference position (Pr60:61).**
- b181.15 Enable counter position from trapezoidal positioner to reference position (Pr60:61).**

OPM11

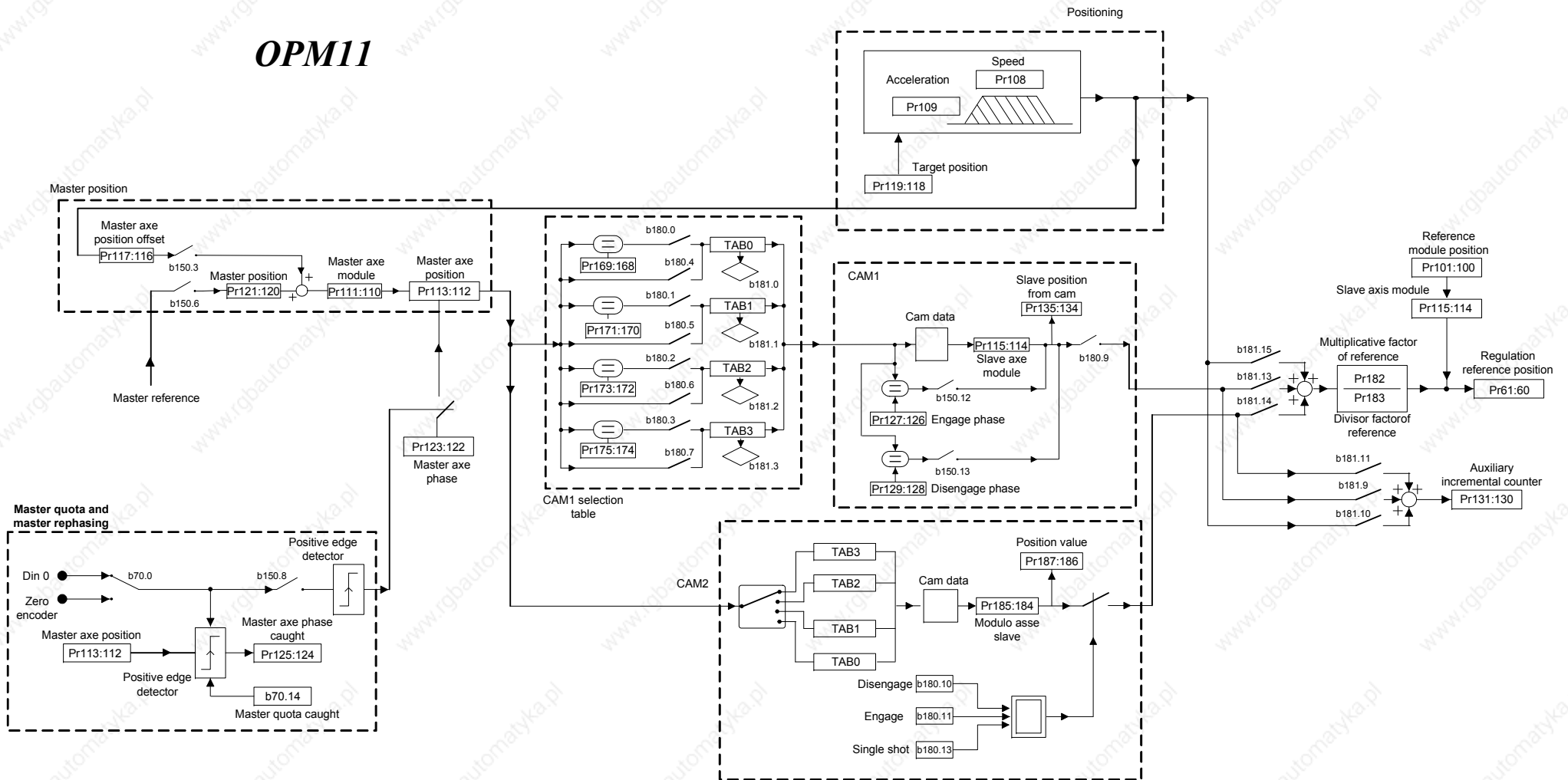

7.6 Position control through the CANbus (operating mode 15)

If the operating mode 15 is enabled, the drive will execute a Position loop of proportional type with feed-forward, the profile generator is regarded as external and it will send the information regarding the position and speed reference via CAN bus, according to the SBCCAN protocol (see chapter CAN bus). If b70.1=0 the feedback is from resolver, if b70.1=1 the feedback is from encoder.

OPERATING MODE 15 PARAMETERS

Par.	Description	Field Unit	Def.	Type/Notes
Pr102	CAN bus status. (see the section on the <i>CANBUS</i>).		0	R/W
Pr103	CAN bus status. (see the section on the <i>CANBUS</i>).		0	R/W
Pr104	Feed-forward speed. The value of this parameter is summed at the output of the position loop in order to obtain the speed request Pr6.	±9000 [rpm]	0	R/W
Pr105	Feed-forward speed via CAN bus. This is the feed-forward value received via the CAN bus. When the SYNC (b150.8=1) is received, Pr105 will be copied to Pr104 and will become active.	[rpm]	0	R/W
Pr114:115	Position reference via CAN bus. This is the position reference received via the CAN bus. When the SYNC (b150.8=1) is received, Pr114:115 will be copied to Pr60:61 and will become active.	[count]	0	R/W
Pr116:117	Motor position via the CAN bus. When the SYNC (b150.8=1) is received, Pr62:63 will be copied to Pr116:117 and, if feedback transmission has been enabled (b150.2=1), it will automatically be transmitted via the CAN bus.	[count]	0	R/W

Par.	Description	Def	Type/ Notes
b150.2	Feedback transmission enable. If = 1, when the type 0 SYNC is received, Pr116:117 will be transmitted via the CAN bus.	0	R/W
b150.3	Reply status. In the cyclic reply message, if b150.3=0 the status consists of the 16 bit of Pr103, otherwise by the first 8 bit only.	0	R/W
b150.4	Low speed mode. In the case Pr48=0: if equal to one, sets the speed of the operating mode of the CAN bus real time to 500kbps, otherwise the speed of the operating mode is 1Mbps.	0	R/W
b150.6	Feedback transmission enable. If = 1, when the type 1 SYNC is received, Pr116:117 will be transmitted via the CAN bus.	0	R/W
b150.8	Sync. The command via the CAN bus of synchronism sets b150.8 to 1 allowing the copy of Pr105 on Pr104, Pr114:115 on Pr61:60 and Pr63:62 on Pr116:117. The references of the position control are updated; after this procedure, b150.8 resets automatically.	0	R/W
b150.10	Type 1 reset. Command to set the motor positions and reference to 0.	0	R/W
b150.11	Type 2 reset. Command that sets the motor position and the reference to the position of the motor shaft Pr28 and Pr64:65 to 0.	0	R/W
b150.12	Type 3 reset. Command that copies the motor position to the reference and sets Pr64 to 0.	0	R/W

opm 15 for Twin drive

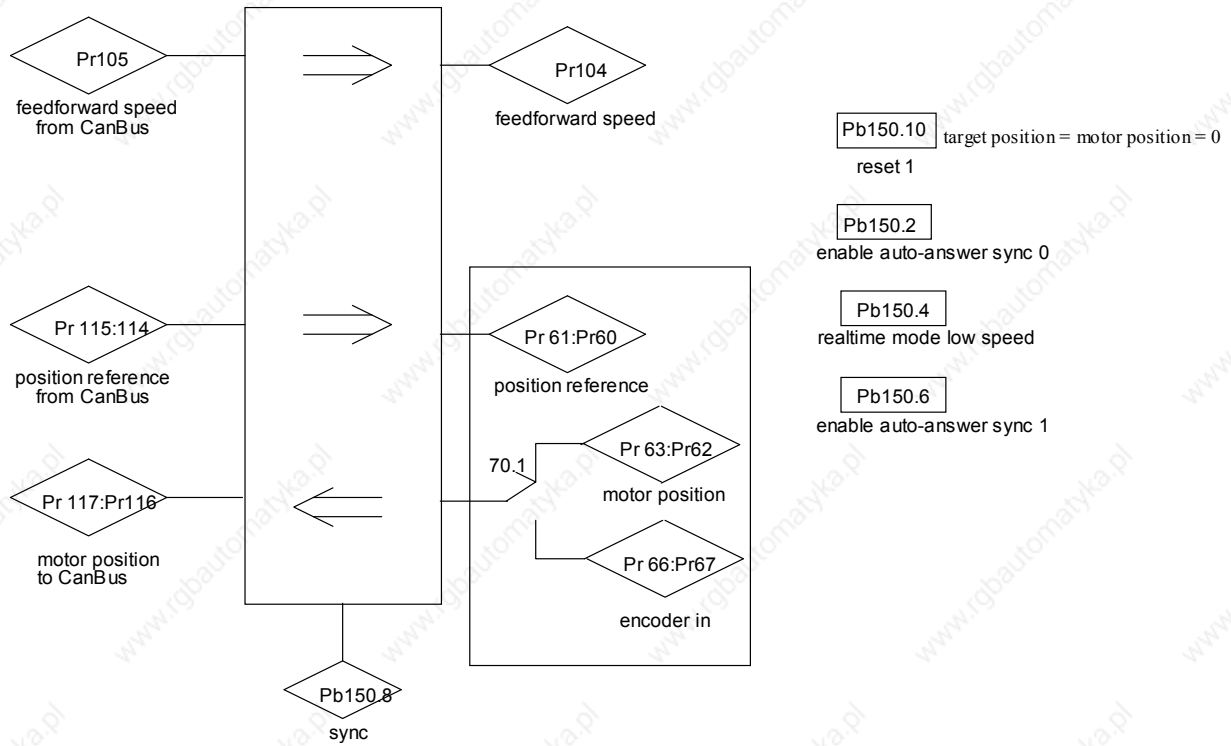

7.7 Basic functions

The standard drive functions include protection functions whose parameters can be set, such as automatic limitations of current delivered based on the estimated dissipation (thermal image or i^2t drive and motor); diagnostic functions, always available to the user, who can always check the drive status; configuration functions for some drive inputs/outputs; the activation of parameter saving/restoring procedures, and further functions common to motion-control equipment.

7.7.1 Homing function

The homing function, which is available exclusively with operating modes 13, 14 or 15, provides a typical axis reset procedure. Before using the homing function perform the following settings:

- connect the homing sensor to digital input 3
- set the homing speed in parameter Pr4 (pay attention to the direction of rotation)
- set Pr5 = 0, b40.12=1, b40.13=0, b40.2=0.

To activate the homing procedure set b94.12=1 for a type 1 reset, or b94.13=1 for a type 2 reset. When the homing procedure is concluded the respective activation bit will be reset. If you wish to abort the procedure, reset the command bit, stop the motor (e.g. by resetting Pr5) and, if necessary, read b40.2 which will remain on zero.

RESET TYPE 1 - DESCRIPTION

When the procedure is activated (b94.12=1) the axis is brought to the speed programmed in Pr4 (Pr5=Pr4); the axis is then brought to zero speed (Pr5=0) on the positive front of the homing sensor signal; after 150ms with the motor stopped parameters Pr61:60 and Pr63:62 are reset, the position loop is enabled by setting b40.2=1, and command b94.12 is reset. The homing sensor signal must be maintained active in high status for the entire duration of the motor stopping phase.

If the homing sensor is already engaged when the procedure is activated, the axis moves at the speed programmed in Pr4 but in the opposite direction until the homing sensor is freed; At this point the procedure continues as described above.

RESET TYPE 2 - DESCRIPTION

When the procedure is activated (b94.13=1) the axis is brought to the speed programmed in Pr4 (Pr5=Pr4); the axis is then brought to zero speed (Pr5=0) on the positive front of the homing sensor signal; after 150ms with the motor stopped parameters Pr61:60 and Pr63:62 are programmed with the value of parameter Pr28, the position loop is enabled by setting b40.2=1, and command b94.13 is reset. The homing sensor signal must be maintained active in high status for the entire duration of the motor stopping phase.

If the homing sensor is already engaged when the procedure is activated, the axis moves at the speed programmed in Pr4 but in the opposite direction until the homing sensor is freed; at this point the procedure continues as described above.

7.7.2 Speed adjustment

In the operating mode default conditions (Pr31=0), the drive adjusts the motor in speed based on the reference value.

The reference origin can be selected with the main block parameters, between analogue (external potentiometer), internal (digital), or external pulse string.

It is possible to make comparison by zero speed, and other speeds, set acceleration and deceleration ramps, change the current and torque limits, and check the drive status.

The main block diagram shows the main drive structure, how the configuration parameters act (bit or Pb parameters) and the main numerical parameters (Pr).

7.7.3 Current or torque adjustment (typical)

To set the converter to Current mode (torque adjustment), the speed ring is excluded by setting b42.2=1.

The main analogue reference is assumed as torque reference (current).

If the nominal current value is exceeded, the thermal image trips as in the speed operation.

7.7.4 Frequency input/output (Encoder ports)

The frequency input/output connector X422 (RS-422) can be configured by the software in different functional modes by using the binary parameters b42.0 b42.5 as given in the table below.

b42.0, and b42.5. See App B for the Signal and counter conventions used.

PAR	Description of the modes
b42.0=0	Incremental Encoder simulation , On encoder out pin; the number of turn pulses must be programmed in Pr 44.
b42.0=1	The function Virtual encoder simulation is enabled (Dummy Master)
b42.5=1	Encoder input is programmed as input in quadrature (phases A and B), this configuration must be used with the operating modes 13 and 14.
b42.5=0	Encoder inputs are programmed as frequency/sign input . The mode must be set when you want to simulate a stepper motor or the pulses train function. The frequency connects to A /A input while the direction connects to B /B input

After the programming, the configuration must be saved and the unit must be powered off and on again. When configured as encoder simulator or o virtual encoder, the counters Encoder In input used by the operating modes are active. Incremental encoder outputs:

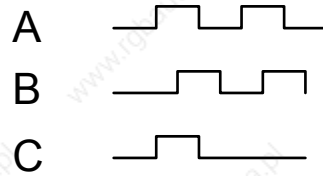

With the “Virtual encoder” function enabled, a virtual encoder (dummy Master) will be available, whose speed will be that set in Pr3. The set speed has a resolution equal to 1 rpm, the limit is the maximum frequency (see the technical data). Output signals (phase A, phase B) will simulate an encoder of Pr44 step / revolution, with phase C of zero not coupled to a reference zero.

7.7.5 Value comparators

These functions are enabled ONLY with operating mode 13 and 14. The Pr96:95 and Pr98:97 parameters have the alternative function of value comparators.

With b94.10 = 0, then b94.8 = 1 if Pr96:95 > Pr63:62 (or Pr66:67 if feedback encoder)

With b94.10 = 1, then b94.8 = 1 if Pr96:95 > Pr61:60

With b94.11 = 0, then b94.9 = 1 if Pr98:97 > Pr63:62 (or Pr66:67 if feedback encoder)

With b94.11 = 1, then b94.9 = 1 if Pr98:97 > Pr61:60

This function is run every 6.144 ms.

If the value comparators functions are not used, the Pr95, Pr96, Pr97, Pr98, b94.10 and b94.11 parameters by the PLC program as general purpose registers.

7.7.6 Value capture

At every positive front of digital input 1, the value of Pr63:62 (or Pr66:67) is captured and stored in Pr68:69 and b70.15 is set to 1 to signal the event. B70.15 is not reset automatically but must be executed by the pico-PLC or the serial line.

Analogous situation, at every positive front of digital input 0, or from reference mark, the value of Pr66:67 is captured and stored in Pr58:59 and b70.14 is set to 1 to signal the event. B70.14 is not reset automatically but must be executed by the pico-PLC or the serial line.

7.7.7 Output programmable on module

This function allows having the status of a digital function based on the position of the motor shaft into a module. The user must set such module in Pr144:145, besides two positions Pr146:147 and Pr148:149 into the module to define the points at which the output 1 must be inverted 1. The initial position value of the motor shaft must be set to parameter Pr142:143, the output status to b91.1 (out 1, pin 12); the function is enabled if b70.3=1 and in this case, Pr142:143 indicates the motor Position in the same module. The Position can be changed placing an offset in Pr140. The digital output is updated every 512 μ s. The limits that can be set are reported in the parameter list; in addition, it should be:

$$0 \leq \text{Pr146:147} \leq \text{Pr148:149} \leq \text{Pr144:145}.$$

7.7.8 Analogue output programmable

In terminal block is available one analogue output programmable (pin: 4 V_{out} e 5 0VA). The parameter Pr188 defines the parameter to monitor. The analogue output scale has a range from -512 to $+512$ counts corresponding $\pm 10V$. By parameter Pr189 is possible to modify the scale: the value is the exponent of base 2.

There are three different cases:

Pr188=Pr0, (monitor speed) has in escape $+10V$ when $Pr0=+Pr32$, while $-10V$ when $Pr0=-Pr32$ [with $Pr189=0$].

Pr188=Pr35, (monitor torque) has in escape $10V$ when Pr35 is equal to pick current, if $Pr19=100\%$ [with $Pr189=0$].

In other cases:

Pr188=Pr..., range in escape ± 512 counts as $\pm 10V$. Therefore if the parameter to monitor necessity more counts, is necessary to attribute, to Pr189, a such value to bring back the scale of reading of the parameter within 512 counts: 2^{Pr189} .

7.7.9 Master reference

There are three different type of master reference:

- Encoder ref.
- Reference on digital bus via CAN (see “*encoder CAN*”)
- Frequency/direction ref.

The type of reference signal must be connected to the relative connector (see par. “*frequency input/output connection*”).

Each reference has a input counter, that encoder signal is calculated on every edge of A and B signal. The counter of the motor position increases 4096 imp/revolution. It's possible to set the relation between master and slave with multiplicative and divisor factors. The encoder ref. from IN2/IN3 can be set as frequency/direction input type or as input in quadrature (b42.4 and b42.5).

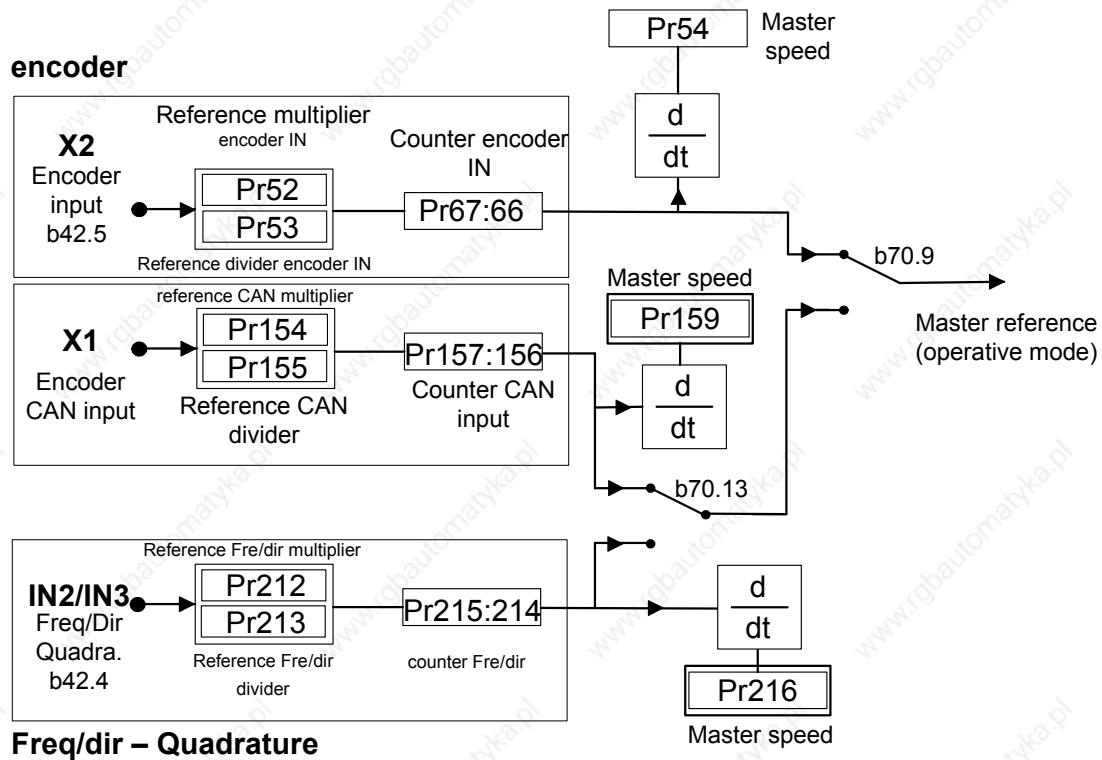

7.7.10 Encoder CAN

If this function is enable, it is possible to generate and receive the “encoder like” signals by the CAN line, which replaces quadratures signal.

The running is transparent, respect to the traditional encoder signals: the CAN line must be connected instead of quadratures signals, and must be considered that every encoder signal is available every 1,024msec over the CAN, and the signal has 4byte for data.

It is possible to have up to a maximum of three encoder signals, if the speed of the CAN is 1Mbs, and only one encoder signal if the speed is 500kbs.

This function is not available when OPM15 is active.

The drive needs some bit and parameters about the correct operation:

- b70.8: enable the encoder CAN function, it activates at the successive switching on after save the setting of the bit.
- b70.9: selects the counter by CAN or encoder input for the OPM.
- b70.10: enable the encoder CAN virtual through the parameter pointed from Pr158.
- Pr154: reduction ratio numerator of the input encoder counting by CAN.
- Pr155: reduction ratio denominator of the input encoder counting by CAN.
- Pr156:157: counter encoder CAN
- Pr158: pointer to the parameter to send as virtual encoder on the CAN.
- Pr159: speed encoder IN via CAN

The encoder CAN is active in input and accepts the CAN signal with address setting into Pr202.

The output encoder CAN is enable if b42.1=0 and it generates a encoder signal with the same address to CAN node. The CAN node address regarding SBC protocol is the value Pr27+1.

If the address of the input encoder (Pr202) is setting at the same value of the output address (Pr27+1), the axe which generates the encoder CAN, reads input the encoder CAN output signal.

If the command b42.0 is enable, is possible to generate a encoder virtual signal. But differently to encoder traditional, setting b70.10=1 the reference isn't the speed into Pr3 but is the position into the parameter pointed from Pr158.

The bit b39.15 is watchdog bit for encoder CAN, and every time that an encoder message arrives the status is 1.

If the encoder CAN function is activated, the number of the free parameter decrease. See the next table.

PAR	MIN	MAX	DEF	DESCRIPTION
154	-32000	+32000		ratio numerator encoder in CAN
155	-32000	+32000		ratio denominator encoder in CAN
156	-231	231		encoder CAN counter
157	-231	231		encoder CAN counter
158	0	255		pointer for encoder out via CAN
159	-9000	+9000		Encoder CAN speed

Not compatible function with operating OPM15

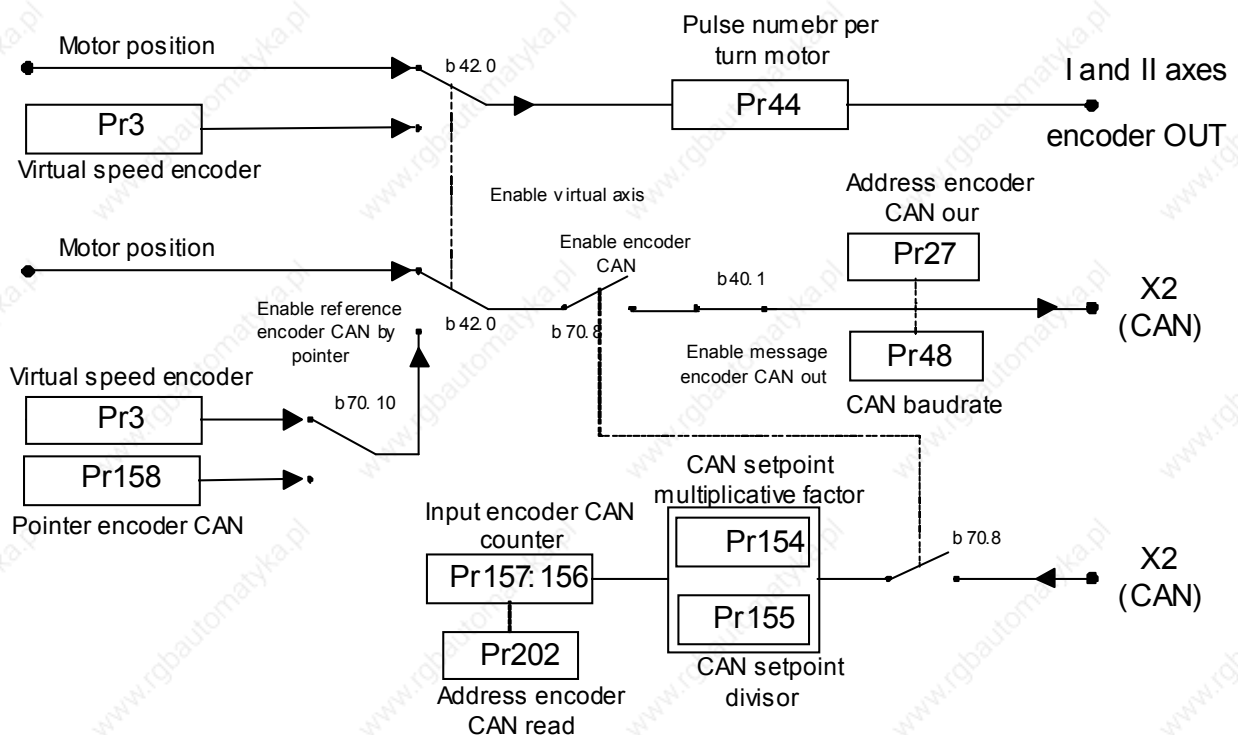

8 Programming digital inputs/outputs

8.1 The pico-PLC

The internal pico-PLC is used to connect the external world (inputs/outputs) with the world of the parameters of the drive. The PLC can be used to copy digital input to a binary parameter, to copy a binary parameter to a digital output and to execute mathematical and Boolean operations. The PLC program must be inserted as a list of instructions by using the keyboard. To change the instructions b99.13 must be set to zero. The default parameter setting (b99.12) corresponds to a PLC program (see *Appendix*) written for a large number of applications. In most cases it is not necessary to program the PLC itself.

The main features of the pico-PLC are:

Program steps	256
scanning time	6,144 ms
number of timers	2
number of instructions	15
stack depth	1
mathematical operations	16 / 32 bits
fast inputs	2 - (512 μs)



Decimal parameters PLC

Par.	Description	field Unit	Def.	Type Note
Pr 71	Constant value =-1 Double Word		-1	R/W
Pr 72	Constant value =0 Double Word		0	
Pr 73	Constant value =1 Double Word		1	
Pr 74	Constant value =2 Double Word		2	
Pr 75	Constant value =10 Double Word		10	
Pr76	Constant value = 100 Double Word		100	
Pr 77	Constant value = 1000. Double word.		1000	
Pr 78	Constant value = 1024. Double word.		1024	
Pr 79	Constant value = 4096. Double word.		4096	
Pr80 ÷Pr89	Free parameters. Parameters that can be stored and available to the user (word).	±32767	0	R/W M
Pr 92	First timer of the PLC. Every 6.144 ms, if Pr92 is different to 0, it is decrement, if it is equal to zero, b99.0=1.	0÷ 32767	0	R/W
Pr 93	Second timer of the PLC. Every 6.144 ms, if Pr93 is different to 0, it is decrement, if it is equal to zero b99.1=1.	0÷ 32767	0	R/W
Pr151 ÷Pr163	Free parameters. Parameters that can be stored and available to the user (word).	±32767	0	R/W M

Parametri bit del pico-PLC

Par.	Description	Def.	Type Note
b90.0	Status of digital input 0. Status of digital input 0.	0	R/W
b90.1	Status of digital input 1. Status of digital input 1	0	R/W
b90.2	Status of digital input 2. Status of digital input 2.	0	R/W
b90.3	Status of digital input 3. Status of digital input 3.	0	R/W
b90.4	Status of digital input 4. Status of digital input 4. In the case of TWIN-N <u>this input is common</u> to I and II axes.	0	R/W
b90.5	Status of digital input 5. Status of digital input 5. In the case of TWIN-N <u>this input is common</u> to I and II axes.	0	R/W
b90.6	Status of safety relay. Status of safety relay: (1) open relay, (0) close relay. In the case of TWIN-N the status of safety relay is common for both axes (see app. "safety disable").	0	R
b90.X	bit that can be stored. If X is greater than 7, this is a bit that can be stored by the user	0	R/W M
b91.0	Status of digital output 0. Status of digital output 0.	0	R/W
b91.1	Status of digital output 1. Status of digital output 1	0	R/W
b91.Y	Available bit. If Y is greater than 1 this is a bit that can be stored by the user.	0	R/W
b94.0	Force a double word formatted operation. When the unit is powered on, this is 0. If it is set to 1, the first mathematical operation executed by the pico-PLC is done by using three double word type operands. After the execution of the operation b94.0 is automatically set to 0. If Pr60..Pr68 Pr110...Pr148 are used, the double word formatting is implicit.	0	R/W
b94.5	First fast input disable (b94.5=1). When the unit is powered on, this is 0.	0	R/W M
b94.6	Second fast input disable (b94.6=1). When the unit is powered on, this is 0.	0	R/W M
b99.0	Status of the first timer. Equal to 1 if Pr92 = 0.	1	R/W
b99.1	Status of the second timer. Equal to 1 if Pr93 = 0.	1	R/W
b99.2	Equal to 1 if the result of the last PLC operation is negative.		R/W
b99.3	Equal to 1 if the result of the last PLC operation is 0.		R/W
b99.13	PLC status. If set to 1, the PLC program is executed. If 0, the program is not executed, but the PLC instructions can be modified.	1	R/W M
b231.5	Time out pico-PLC (1). If the microprocessor is overloaded with work (the operating mode is active, there are frequent serial requests and the PLC program is long), it may take more than 6.144 milliseconds to scan the entire PLC program (b231.5=1).	0	R

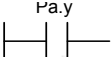
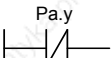
PLC INSTRUCTIONS

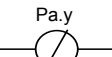
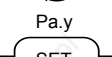
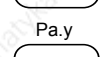
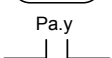
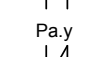
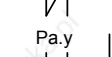
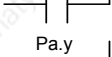
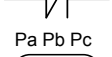
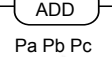
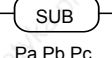
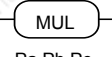
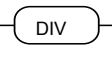
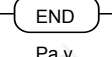
	LD	Pa,y	loads the y bit of the Pa parameter on the stack
	LDN	Pa,y	loads the negated y bit of the Pa parameter on the stack
	OUT	Pa,y	sets the y bit of the Pa parameter to the value loaded on the stack
	OUTN	Pa,y	places the y bit of the Pa parameter to the value of stack negating it
	SET	Pa,y	if the stack = 1, the y bit of the Pa parameter is set to 1
	RES	Pa,y	if the stack = 1, the y bit of the Pa parameter is set to 0
	AND	Pa,y	if the bit loaded on the stack contains the result of the logical AND operation between itself and the y bit of the Pa parameter
	ANDN	Pa,y	the bit of the stack contains the result of the logical AND operation between itself and the y bit of the negated Pa parameter
	OR	Pa,y	the bit loaded on the stack contains the result of the logical OR operation between itself and the y bit of the Pa parameter
	ORN	Pa,y	the bit on the stack contains the result of the logical OR operation between itself and the y bit of the negated Pa parameter
	ADD	Pa, Pb, Pc	if the bit on the stack = 1, the addition operation is executed on the parameters in which: $Pc = Pa + Pb$
	SUB	Pa, Pb, Pc	if the bit on the stack = 1, the subtraction operation is executed on the parameters in which: $Pc = Pa - Pb$
	MUL	Pa, Pb, Pc	if the bit on the stack = 1, the multiplication operation is executed on the parameters in which: $Pc = Pa \cdot Pb$
	DIV	Pa, Pb, Pc	if the bit on the stack = 1, the division operation is executed on the parameters in which: $Pc = Pa / Pb$
	END		end of program
	FIN	y, 0/1	input with fast scanning

FUNCTIONAL DESCRIPTION

The Pico-PLC program is scanned every 6.144 milliseconds. Based on this sampling, the inputs are first read, then the two timers (Pr92 Pr93 b999.0 and b99.1) are updated, the user program is scanned and finally outputs are updated. For this reason, both input reading and output setting can vary by 6.144 ms with respect to the physical event. If the microprocessor is overloaded with work (the operating mode is active, there are frequent serial requests and the PLC program is long), it may take more than 6.144 milliseconds to scan the entire PLC program (b231.5).

All the instructions of the Pico-PLC with the exception of the arithmetic instructions are single bit instructions. The available stack has a depth of only one bit.

The LD (LDN) instruction loads the bit defined as an operand on the stack, while all the other logical instructions work on the stack. Arithmetic instructions are executed only if the stack bit is set to 1.

For user convenience, truth tables of logical operations are given below.

AND logical operation		
result	bit B	risultato
0	0	0
0	1	0
1	0	0
1	1	1

OR logical operation		
result	bit B	risultato
0	0	0
0	1	1
1	0	1
1	1	1

The respective negative operations ANDN and ORN follow the same logic except that the negated value of the bit specified will be used.

9 bits from b90.7 to b90.15 are reserved on the PLC and can be stored. 14 additional bits from b91.2 to b91.15 are available on the PLC but cannot be stored. They are always set to 0 when the converter is powered on.

10 word parameters are also reserved. These are from Pr80 to Pr89. They can be stored and used as 5 double word parameters just as the 13 parameters from Pr151 to Pr163. 7 of this 13 parameters can be reserved if the Encoder CAN function is active (see par. "encoder CAN").

The pico-PLC includes 9 constants for arithmetic operations. These are from Pr71 to Pr79 and can be the constants most used by normal applications.

Remember that the array of the parameters is increased to complete the new operative mode, the parameters from Pr168 to Pr189 are available on the PLC but cannot be stored (N.B. the parameters from Pr164 to Pr167 are reserved and the user can not modify these).

When the arithmetic operations (ADD, SUB, MUL, DIV) are used, the operators are assumed to be words and are signed. If a double word operation is required, set b94.0 = 1 before the operation itself. After the operation the PLC will automatically set this bit to 0. The parameters Pr58...Pr69 and Pr110...Pr149 are treated as double words so that in an operation such as [ADD 71 72 64] the result -1 will be written in the double word Pr64:65 without having to set b94.0=1 before the operation. If Pr80=-1 and Pr81=0 the operation [ADD 80 72 64] will give the result Pr64:65=-1, while the same operation executed with b94.0=1 will assume Pr81 as the high word of the double word Pr80:81 and the result will be Pr64:65=65535. In the first case, operators other than Pr58...Pr69, Pr110...Pr149 are treated as words, while in the second case they are treated as double words.

In the mathematical operations on double words, the operands and the result are defined as follows: the parameter of the operand defines the least significant part while the most significant part is represented by the next word.

After every arithmetic operation, $b99.2=0$ if the result is positive and $b99.2=1$ if it is negative. In the same way $b99.3=1$ if the result is 0 and $b99.3=0$ if it is not 0. These settings remain active until the next arithmetic operation is executed (the operation is executed only if the stack bit is equal to 1). A mathematical operation can be executed by placing the result in one of the constant parameters (Pr71...Pr79) in order to set bit $b99.2$ and $b99.3$.

If the DIV operation is executed on a double word, the most significant part of the result contains the remainder of the division, that is, if $b94.0=1$ and the operation [DIV 79 77 80] is executed, the result will be Pr80=4 and Pr81=96.

The FIN instruction. Two instructions are available for the fast acquisition of inputs: in this case the scanning occurs at the rate of $512\mu s$ (normal scanning is at the rate of 6.144ms). If this is used, they must be the first instructions of the PLC. The first instruction FIN copies digital input 0 to the y bit of the Pb40 parameter (the second operand =0) or Pb150 (the second operand=1). The second FIN copies digital input 1 to the y bit of the Pb40 parameter (second operand=0) or Pb150 (second operand=1). If the value 2 is added to the second operand, the input must be negated before being copied. If an FIN instruction is inserted in a different position, it will not have any effect. The FIN instructions can be enabled/disabled using a bit for each FIN: the first FIN is enabled if $b94.5=0$; the second FIN is enabled if $b94.6=0$. The FIN instruction inserted in the PLC program after the first two instructions and in any case if it follows any instruction that is not a FIN instruction is ignored.

The user can make use of two timers, Pr92 and Pr93. To use the first timer load the time as a number of sampling (6.144 ms) into PR92. For example, Pr92=100 is equal to 614 milliseconds. Pr92 will automatically be decremented as time goes by and the $b99.0$ bit will remain set to 0 until the timer has expired. When Pr92=0, then $b99.0=1$. The second timer works the same way using the PR93 parameter and the $b99.1$ bit. Pr92, Pr93, $b99.0$ and $b99.1$ are updated only before the pico-PLC program is scanned.

The maximum number of instructions is 256. The arithmetic operations occupy the space of two logical operations. If they are used, the maximum number of instructions accepted is reduced.

The PLC program must always end with the END instruction.

The pico-PLC program can be edited via serial link or directly using the keyboard. In this last case, in order to facilitate the modification of the program, if you want to delete an instruction, go to the instruction to be deleted and hit the [M] key. The type of instruction is then displayed. By holding down the [M] key and pressing the [-] key, the instruction will be deleted when both keys are released. If you want to add an instruction after the In06, go to the next instruction In07 and hit the [M] key. The type of instruction is then displayed. By holding down the [M] key and pressing the [+] key, the FIN instruction will be inserted when both keys are released. In this last case make sure that the program does not exceed the maximum limit of the instructions, otherwise the last instructions will be lost. The pico-PLC program can be edited or modified only when the PLC is in stop ($b99.13=0$).

8.2 Programming with MotionWiz

The **serial kit** is supplied to enable communication between a PC and the drive. The kit includes an RS-422/RS-232 converter, relative 230V~ power supply and serial connection cable. The enclosed communication software (supplied free of charge) designated **MotionWiz** has the following HW/SW requirements: PII microprocessor or higher, *Windows2000* or more recent version, mouse and serial port for drive connections. The main features of MotionWiz are:

- serial connection of up to 32 drives
- reading and setting of basic parameters and drive commands
- reading and setting of commands and parameters of operating modes
- functional block diagrams
- pico-PLC program displayed as ladder diagrams
- display of pico-PLC program status during operation
- I/O status
- file storage of parameterisation including pico-PLC program
- uploading of parameterisation including pico-PLC program from a file that can be selected from among those previously stored
- oscilloscope function

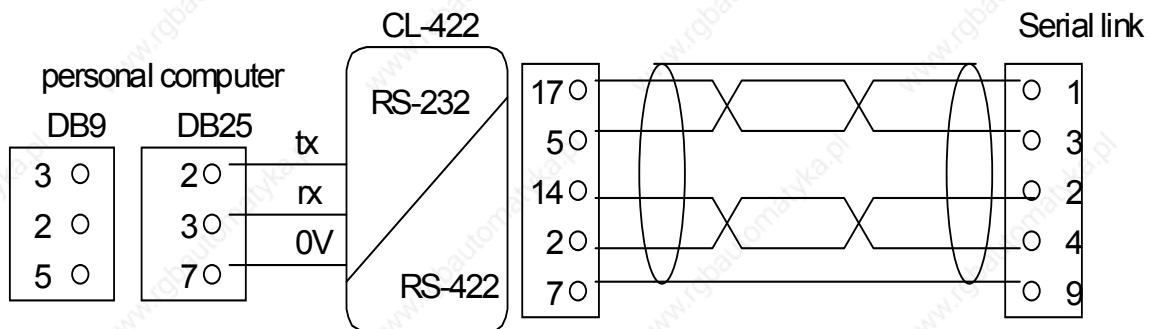

8.3 MotionWiz

The configuration tool is called “MOTIONWIZ” and is used to program the drive while controlling the whole system in real time. PLC programs can also be edited and new files can be generated.

The first step is to install the program*:
click on the icon “SetupMotionWiz.exe”



Follow the instructions that appear during the installation . An icon linking to the program will be generated on your desktop at the end of the installation process :



Click on the icon to start the configuration program. The following window will be displayed on your monitor:

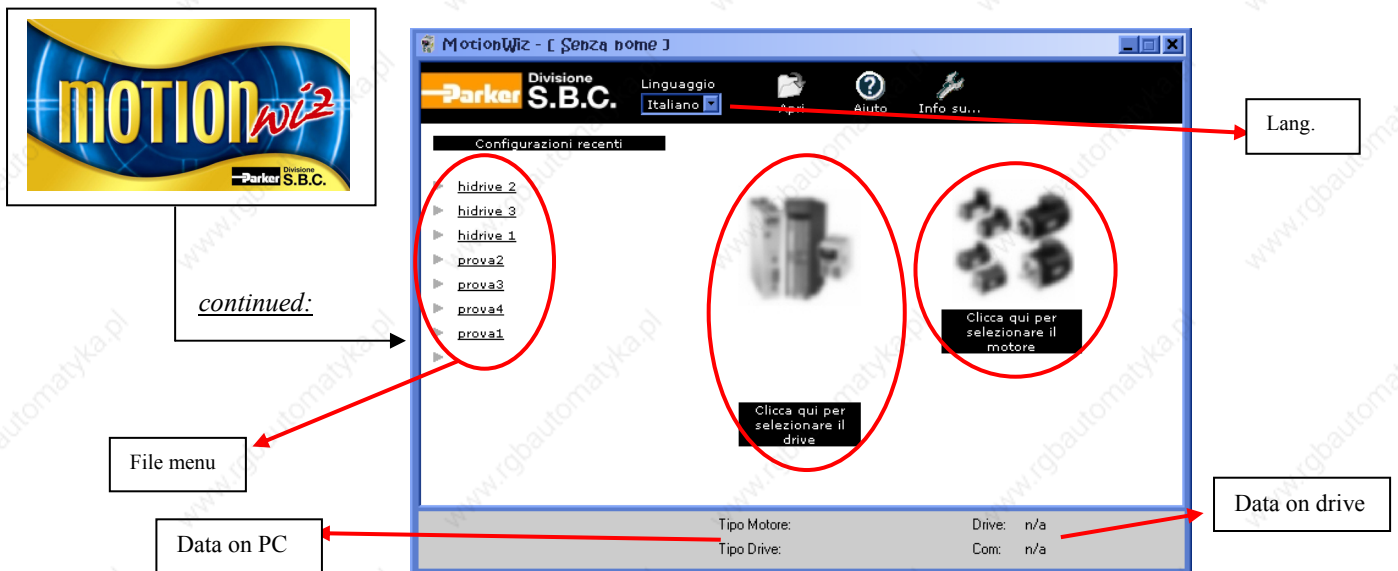

It is possible to select the desired language: Italian or English.

How to generate a new file:

to set the data for motor and drive, use the databases provided by the software, that can be accessed through the icons below the figures (when the drive and the motor pictures are out of focus, it means that the relevant data have not been set yet).

Press “ENTER” to access the configuration functions.

How to use an existing file:

the “file menu” shows a list of most recent files. To open a file, click on a name in the list. Alternatively, using the “Open” tab it is possible to “search” previously stored files selecting the relevant route.



* The MotionWiz program can be found on the CD rom supplied with the drive or downloaded from our website: www.sbcelettronica.com

System required **Propriety video**

O. S.: Windows2000 SP4, XP SP2; *Browser:* Internet Explorer ver. 6.0 Mouse.
[SETTINGS] video resolution advised: 1024*768, 1280*1024; [SETTINGS - ADVANCED] settings DPI: normal 96dpi; [APPARANCE] character dimensions: normal.

9 SERIAL INTERFACE

The serial communication of the converter is half-duplex, master-slave, using an asynchronous RS-485/RS-422 line. The converters take control of the line only if interrogated by the master.

The same serial line can be connected to up to 32 converters by setting a different serial address in each to the Pr27 parameter. It is also possible to set the transmission speed by using the Pr26 parameter as specified in the table below:

Pr26 (decimal base)	b/s	time-out (ms)
0	600	512
1	1200	256
2	2400	128
3	4800	64
4	9600 (*)	32
5	9600	32
6	19200	16
7	38400	12
8	57600	8

For the connection diagrams, see the section, *Connecting the serial line*.

9.1 Communication protocol

The column on the right in the table above shows the time-out value expressed in milliseconds for each communication speed. This is the time within which the message must be sent, beginning from the start of each message (STX). If a message is interrupted after this time, the converter ignores what has been received and waits for the beginning of a new message.

The message consists of several consecutive bits. The format of the bits is the following:

- 1 start bit
- 8 bit of data defined by a following byte enclosed within brackets
- 1 parity bit (even)
- 1 stop bit

The structure of the message is the following:

[STX] [CMD+ADDR] [BK+LUN] [PAR] [D0]... [Dn] [CHK]

where:

[STX] = \$7E indicator of transmission start. If a field in the message different from STX assumes the value \$7E, this field is followed by a 0 (\$00) so that it will not be interpreted as an [STX].

[CMD+ADDR] = command and address of the peripheral device. This is never 0. This data is composed in the following way: the first 5 bits (bits 0-4) define the address of the converter (from 0 to 31); the remaining 3 bits (bits 5-7) define the type of message sent, as described in the following table:

CMD	bit 7	bit 6	bit 5	type of message
-----	-------	-------	-------	-----------------

1	0	0	1	converter response
2	0	1	0	reading a pico-PLC instruction
3	0	1	1	writing a pico-PLC instruction
4	1	0	0	reading a parameter
5	1	0	1	writing a parameter
6	1	1	0	bit modification
7	1	1	1	writing a parameter to all the slaves

[BK+LUN] = the LUN field (first 3 bits) indicates the number of bytes of the data transmitted (a parameter or a PLC instruction); the values can range from 1 to 4. This value does not include eventual 0 characters (\$00) which are inserted after the values that coincide with the character of transmission start (\$7E). The length of each parameter is two bytes.

The BK field is represented by the 5 most significant bits and represents the 5 most significant bits of the parameter address.

[PAR] = write/read address of the parameter or PLC instruction.

The parameter address is the number of the parameter * 2 with 13 bit field: PAR represents the least significant eight bits of the address, the 5 most significant bits must be written in the BK field.

The table CAM0 used by electronic cam starts at the address from 4096 to 4609, the table CAM1 starts at the address from 4610 to 5123, the table CAM2 starts at the address from 5124 to 5637, the table CAM3 starts at the address from 5638 to 6151. The PLC instructions have the address from 0 up to 511.

[D0]... [Dn] = data transmitted.

[CHK] = 256 module sum of all the fields excluding the [STX] (checksum).

Message types

[CMD1] = is the response message of the converter to a data request. The response message has the following format:

[STX] [001+ADDR] [BK+LUN] [PAR] [D0]... [Dn] [CHK]

or it can be the confirmation message to a data write or data modify. In this case, the format is the following:

[STX] [001+ADDR]

where ADDR always identifies which converter is answering.

[CMD2] = is the read message of an instruction in the PLC area. The message has the following format:

[STX] [010+ADDR] [BK+LUN] [PAR] [CHK]

[CMD3] = is the write message to an instruction in the PLC area. The message has the following format:

[STX] [011+ADDR] [BK+LUN] [PAR] [D0]... [Dn] [CHK]

[CMD4] = is the read message of a parameter. The message has the following format:

[STX] [100+ADDR] [BK+LUN] [PAR] [CHK]

[CMD5] = is the write message of a parameter. The message has the following format:

[STX] [101+ADDR] [BK+LUN] [PAR] [D0]... [Dn] [CHK]
 [CMD6] = is the change bit message of a byte parameter. The message has the following format:

[STX] [110+ADDR] [BK+LUN] [PAR] [D0] [D1] [CHK]

In this case LUN=2 or else two bytes are sent for the data. The first byte is the mask containing the 0s in the positions of the bits to be changed and 1s in the other positions, while the second byte contains 1s in the positions of the bits that are to be set to 1 and 0s in the other positions. The PAR address is that of the parameter (byte) where one or more bits are to be modified. If the parameter is a word and the bit to be modified is one of the first 8 (b0...b7): PAR = the parameter address; otherwise, if the bit to be modified is one of the upper 8 (b8...b15): PAR = the address parameter + 1.

[CMD7] = is the write message of a parameter to all converters connected to the serial line. The message has the following format:

[STX] [11100000] [BK+LUN] [PAR] [D0]... [Dn] [CHK]

The address of the peripheral device (ADDR) must be 0.

Notes:

- The parameters that are represented on the screen with decimals must be treated as complete values. For example, a value of 978.5 is read and written as 9785.
- All values that are preceded by the \$ symbol are to be understood as hex numbers.
- The value included inside the brackets identifies the base unit (byte) of the message.
- All messages must be terminated with a time-out which is a function of the speed, well defined to be considered valid and must have the exact parity and checksum.
- The converter responds to a request or to a data send only if the message has been received correctly. In the case of an error in the message, no response is transmitted. The only exception is message type 7 that is used to send data with a single message to all the converters connected to the serial line.

Initializing and managing the serial line

The converter is delivered with a 0 address (Pr27=0) and a speed of 9600 bps (Pr26=5).

To modify the configuration, first set the speed in Pr26, then the serial address in Pr27 and finally initialise it by issuing the command b42.3. Use the b99.15 command to store the configuration.

Each pico-PLC instruction occupies 2 or 4 bytes whose format is the following:

Since the maximum length of each instruction is 2 bytes and the total area available in the PLC is 512 bytes, the PLC program can have at the most 256 instructions.

Instruction	Code	Length (bytes)
LD Pa.y	0	2
LDN Pa.y	1	2
OUT Pa.y	2	2
OUTN Pa.y	3	2
AND Pa.y	4	2
ANDN Pa.y	5	2
OR Pa.y	6	2
ORN Pa.y	7	2
ADD Pa, Pb, Pc	8	4
SUB Pa, Pb, Pc	9	4
MUL Pa, Pb, Pc	10	4
DIV Pa, Pb, Pc	11	4
SET Pa.y	12	2
RES Pa.y	13	2
FIN b40.y/b150.y	14	2
END	15	2

The first 4 bits (b0..b3) of the first byte in each instruction contain the instruction code.

In the first 8 instructions in the table (LD... ORN) and the SET and RES instructions, the remaining 4 bit of the first byte (b4..b7) contain the value y, while the second byte contains the value Pa.

In the ADD, SUB, MUL e DIV instructions, the second byte contains the value Pa, the third byte the value Pb, and the fourth byte the value Pc.

In the END instruction, the second byte is not used.

In the FIN instruction, the fifth bit (b4) of the first byte selects the parameter: b4=0 if it refers to Pb40, b4=1 if it refers to Pb150; the sixth bit (b5) of the first byte is used for logical negation: b5=0 the bit is copied, b5=1 the bit is negated before being copied. The second byte of the FIN instruction contains the value of y.

If the FIN instructions are used, they must be the first instructions of the program and cannot be more than 2. They occupy the addressed from 0h to 3h. If a FIN instruction is inserted beginning at the 4h address or after any other instruction, the FIN instruction does not function and is ignored (NOP).

The instructions must follow each other beginning at address 0h and no byte can be left empty.

There is only one program and it is terminated with the END instruction.

Examples of using the serial line

In order to better understand how to implement the communication protocol on the serial line, some examples of each type of message are given below.

The values indicated are only indicative as examples.

First example: reading a 1 byte parameter

Suppose we want to read the value of the parameter Pr25 (release software) and that its value is 43. Suppose also that the converter has the serial address 0. The message to be sent is the following.

[$\$7E$][$\80][$\$01$][$\32][$\$B3$]

The converter responds with the message:

[7E][20][01][32][2B][7E][00]

Second example: reading a 2 byte parameter

Suppose we want to read the reference speed (Pr7) and that its value is 2000. Suppose also that the converter has the serial address 1. The message to be sent is the following:

[7E][81][02][0E][91]

The converter responds with the message:

[7E][21][02][0E][D0][07][08]

Third example: writing a 1 byte parameter

Suppose we want to select operating mode 1 (Pr31). Suppose also that the converter has the serial address 3. The message to be sent is the following:

[7E][A3][01][3E][01][E3]

The converter responds with the message:

[7E][23]

Fourth example: writing a 2 byte parameter

Suppose we want to set the rated current to 2.5 A (Pr33). Suppose also that the converter has the serial address 3. The message to be sent is the following:

[7E][A3][02][42][19][00][00]

The converter responds with the message:

[7E][23]

Fifth example: setting a bit to 1

Suppose we want to send the command to save the PLC program (b99.14=1). Suppose also that the converter has the serial address 0. The message to be sent is the following:

[7E][C0][02][C7][BF][40][88]

The converter responds with the message:

[7E][20]

Sixth example: setting a bit to 0

Suppose we want to disable the converter via software (b40.9=0). Suppose also that the converter has the serial address 0. The message to be sent is the following:

[7E][C0][02][51][FD][00][10]

The converter responds with the message:

[7E][20]

Seventh example: writing a PLC instruction

Suppose we want to set the first instruction of the PLC as: LD 90.4. Suppose also that the converter has the serial address 0. The message to be sent is the following:

[7E][60][02][00][40][5A][FC]

The converter responds with the message:

[7E][20]

10 CAN bus interface

A CAN bus interface based on the physical layer ISO/DIS11898 is included on the converter. The Data link layer is the full CAN version 2.0 part A (ID 11 bit) and a subset of the application layer SBCCAN is used.

Are available two CAN protocols:

1. SBC CAN (standard)
2. CANopen (requested: C or D version)

Note: to be expressly requested when placing your order: the drive may only have one protocol at a time

10.1 SBC CAN

The CAN bus on the drive has two functional modes.

The first functional mode is **real time mode**. This is to establish a real time digital link between 15 drives and a control that executes the calculation of the trajectories and sends the position reference, the speed reference or both to the devices which can change the actual position of the motors (b150.2=1). Real time mode is active when Pr31=15.

The second functional mode is **communication mode**. This is used to write or read every parameter of each drive connected to the bus (maximum of 15). This function is very useful when you want to sue the motion functions that have already been realized in the base software of the device. Communication mode is automatically set when Pr31≠15.

The CAN bus node must be set through Pr27 with values from 0 to 14 (*).

Transmission speed depends on Pr31, Pr48 e b150.4 as the following table:

Pr48	Pr31≠15	Pr31=15	b150.4
0	125 kbps	1 Mbps	0
0	125 kbps	500 kbps	1
1	1 Mbps		
2	500 kbps		
3	250 kbps		
4	125 kbps		
5	50 kbps		
6	20 kbps		
7	10 kbps		

For bus length greater then about 1000 m bridge or repeater devices may be needed.

All changes in speed, address or function mode are activated using the b42.3 command or when the converter is powered on again.

(*) In the messages via CANbus, the node number is identified through Pr27+1:

- in real-time 1 to 15;
- in communication 1 to 31.

10.1.1 Description of the fields in real time mode

Cyclic message from the master to the DRIVE

Cyclic data															
Data length	8/6/4 bytes														
Field Name	Position Reference					Speed Reference					Command				
Contents	Pr114:115 (32 bit)					Pr105 (16 bit)					Pr102 (16 bit)				
Identifier															
ID2	ID1	ID0	-	-	-	-	-	ID10	ID9	ID8	ID7	ID6	ID5	ID4	ID3
A2	A1	A0	X	X	X	X	X	0	0	0	0	0	1	1	A3

A0:A3 drive slave address (Pr27+1), valid values 1..15.
Pr102 is used as a command and must be managed by the pico-PLC.
The data type depends on the message length as follows:

Data length	Contents	Contents	Contents
8	Position reference (4 byte)	Speed reference (2 byte)	Pr102 (2 byte)
6	Position reference (4 byte)	Pr102 (2 byte)	
4	Speed reference (2 byte)	Pr102 (2 byte)	

Synchronism message from the master to the drive

Synchronism message															
Data length	1 byte														
Field Name	Sync														
Contents	Sync type (8 bit)														
Identifier															
ID2	ID1	ID0	-	-	-	-	-	ID10	ID9	ID8	ID7	ID6	ID5	ID4	ID3
0	0	0	X	X	X	X	X	0	0	0	0	0	0	0	0

Type 0 synchronism (Sync = 0): every drive activates the speed references and the position references and stores the actual position of the motor; if b150.2=1 the drive answers with a “cyclic reply”.

Type 1 synchronism (Sync = 1): stores the actual position of the motor; if b150.6=1 the drive answer with a “cyclic reply”.

Cyclic message from the drive to the master

Cyclic reply															
Data length	6/7 byte														
Field Name	Address					Motor Position					Status				
Data	Pr27+1 (8bit)					Pr116:117 (32 bit)					Pr103				
Identifier															
ID2	ID1	ID0	-	-	-	-	-	ID10	ID9	ID8	ID7	ID6	ID5	ID4	ID3
A2	A1	A0	X	X	X	X	X	0	0	0	1	0	1	0	A3

A0:A3 drive slave address (Pr27+1), valid values 1..15.

The Pr103 parameter is used as the status, if b150.3=0 all the 16 bits are sent, if b150.3=1 only the first 8 bits are sent.

If b150.0=1 the message is 8 byte long, and it isn't dependent on b150.3; Pr103 made up of 16 bit. When b150.1=1, the message has the following information:

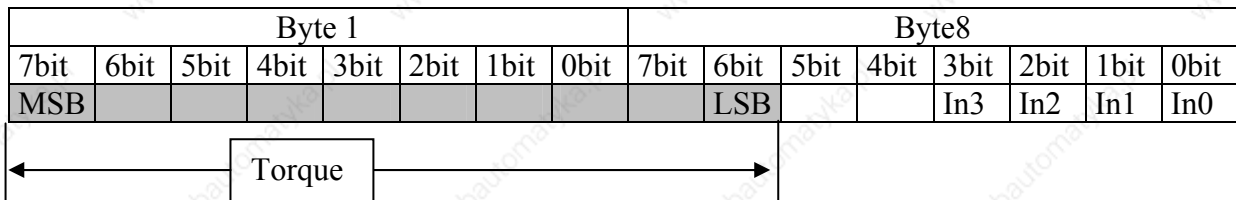
**MultiCyclic message from master to the drive**

MultiCyclic data																
Data length	2,4,6,8 byte															
Field Name	Speed Reference 0				Speed Reference 1				Speed Reference 2				Speed Reference 3			
Contents	Pr105 (16 bit)				Pr105 (16 bit)				Pr105 (16 bit)				Pr105 (16 bit)			
Identifier																
ID2	ID1	ID0	-	-	-	-	-	ID10	ID9	ID8	ID7	ID6	ID5	ID4	ID3	
0	A1	A0	X	X	X	X	X	0	0	0	0	1	1	1	0	

This message contains several data which are sent to several slave drives. One data (speed reference) is addressed for one drive, based on an addressing logic. The following table shows which information (speed reference, Pr105) is sent to which drive, based on the A0:A1(=group address) value.

A0:A1	Speed reference 0	Speed reference 1	Speed reference 2	Speed reference 3
0	Drive 1	Drive 2	Drive 3	Drive 4
1	Drive 5	Drive 6	Drive 7	Drive 8
2	Drive 9	Drive 10	Drive 11	Drive 12
3	Drive 13	Drive 14	Drive 15	

MultiSynchronism message from the master to the drive

MultiSynchronism message															
Data length	1,2,3,4 byte														
Field Name	Command 0				Command 1				Command 2				Command 3		
Contents	Pr102 (8bit)				Pr102 (8bit)				Pr102 (8bit)				Pr102 (8bit)		
Identifier															
ID2	ID1	ID0	-	-	-	-	-	ID10	ID9	ID8	ID7	ID6	ID5	ID4	ID3
0	0	0	X	X	X	X	X	0	0	0	0	0	1	0	0

Each drive receives and executes the speed reference and saves the actual motor position; if b150.2=1 the drive answers with a “cyclic reply”.

This message is for several drives. The following table shows to which drive the “Command” (Pr102 – first 8 bit) is sent to.

Drive	Command0	Command 1	Command 2	Command 3
Drive1	YES			
Drive2	YES			
Drive3		YES		
Drive4		YES		
Drive5			YES	
Drive6			YES	
Drive7				YES
Drive8				YES
Drive9	YES			
Drive10	YES			
Drive11		YES		
Drive12		YES		
Drive13			YES	
Drive14			YES	
Drive15				YES

Each command is made up of 8 bit (Pr102) and it is sent to several drives. Each command value is set by the user through the pico-PLC of each drive.

Acyclic data write message or parameter request from the master to the drive

Acyclic data write or request															
Data length	7 byte														
Field Name	Cmd & Len							Data Address				Data			
Contents	5 bit command and 3 bit length							16 bit data address				32 bit data			
Identifier															
ID2	ID1	ID0	-	-	-	-	-	ID10	ID9	ID8	ID7	ID6	ID5	ID4	ID3
A2	A1	A0	X	X	X	X	X	0	0	0	0	1	0	0	A3

A0:A3 SLVD_N slave address (Pr27+1), valid values 1..15.

Cmd & Len	Sub-field	Value	Meaning
Cmd [0..4]		0	Read request
		1	Write
		2	SET bit
		3	RESET bit
		4	TOGGLE bit
		5 – 31	Not use
Len [5..7]		0- 4	Number of significant bytes in the data field

Data Address

This is the address of the parameter interested in the operation (parameter number * 2).

The PLC instructions have the address from 8192 up to 8703.

The electronic cam0 table have the address from 4096 to 4609.

The electronic cam1 table have the address from 4610 to 5123.

The electronic cam2 table have the address from 5124 to 5637.

The electronic cam3 table have the address from 5638 to 6151.

Data

If the parameter is written, it contains the value of the parameter.

If one or more bits are modified, it contains the mask of the bits to be modified.

If the parameter is to be read, the field has no meaning.

If plc programme is written, it contains the instruction code (see the section *Serial interface*).

Acyclic response message to a parameter request from the drive to the master

Data reply															
Data length	5 bytes														
Field Name	Addr & Spare							Data							
Contents	Pr27+1							32 bit reply data							
Identifier															
ID2	ID1	ID0	-	-	-	-	-	ID10	ID9	ID8	ID7	ID6	ID5	ID4	ID3
A2	A1	A0	X	X	X	X	X	0	0	0	1	1	0	0	A3

A0:A3 drive slave address (Pr27+1), valid values 1..15.

Broadcast write parameter message from the master to the drive

Broadcast data write															
Data length	7 bytes														
Field Name	Cmd & Len							Data Address				Data			
Contents	5 bit command and 3 bit length							16 bit data address				32 bit data			
Identifier															
ID2	ID1	ID0	-	-	-	-	-	ID10	ID9	ID8	ID7	ID6	ID5	ID4	ID3
1	1	1	X	X	X	X	X	0	0	1	0	0	0	1	1

Cmd & Len	Sub-field	Value	Meaning
	Cmd [0..4]	0	Not used
		1	Write
		2	SET bit
		3	RESET bit (.NOT.Data)
		4	TOGGLE bit
		5 – 31	Not used
	Len [5..7]	0- 4	Number of significant bytes in the data field
			Pr = Pr .OR. Data
			Pr = Pr .AND.
			Pr = Pr .XOR. Data

Data Address

This is the address of the parameter interested in the operation (parameter number * 2).
The PLC instructions have the address from 8192 up to 8703.

Data

If the parameter is to be written, it contains the value of the parameter.
If one or more bits are modified, it contains the mask of the bits to be modified.
If plc programme is written, it contains the instruction code (see the section *Serial interface*).

Alarm message from the drive to the master

Error															
Data length	3 bytes														
Field Name	Addr							Error							
Contents	Pr27+1							Pr23							
Identifier															
ID2	ID1	ID0	-	-	-	-	-	ID10	ID9	ID8	ID7	ID6	ID5	ID4	ID3
A2	A1	A0	X	X	X	X	X	0	0	0	1	0	0	0	A3

A0:A3 drive slave address (Pr27+1), valid values 1..15.

If the converter is in the alarm status, it will send this message on the bus (alarm 0 = no alarm).

To evaluate the minimum sampling time, use the following formula:

$$T_{c_{\min}} = (N_r + N_t + 5) * 0.12$$

where: $T_{c_{\min}}$ is the minimum sampling time in milliseconds
 N_r is the number of drive that receive the reference
 N_t is the number of drive that transmit the feedback
 The constant 0.12 is valid for 1 Mbps bus speed

Note 1: bit 41.15 can be used in “real time mode”; bit 41.15 is set to 1 every synchronism and multisynchronism message receiving via SBCCAN.

Therefore, it is possible to check the communication status between Master and Slave via CAN bus through a simple pico-PLC program.

The pico-PLC code on the drive be as follows:

```
...
Ld 41.15
Out 41.5
Rst 41.15
...
```

If the check of the communication status between Master and Slave via CAN bus is implemented into the drive pico-PLC, the test is executed every 6.144 [ms] (i.e. minimum execution time of pico-PLC program) or multiples.

Attention: both Pr103 (Status) and Pr102 (Command) must be set through a specific pico-PLC program into each drive.

Note 2: the Master can send the new reference data only if at least 400 [μs] passed from the last synchronism message, or if the response message has already been received.

The typical timing of the SBCCAN in real time mode is shown in the diagram on the next page:

SBCCAN

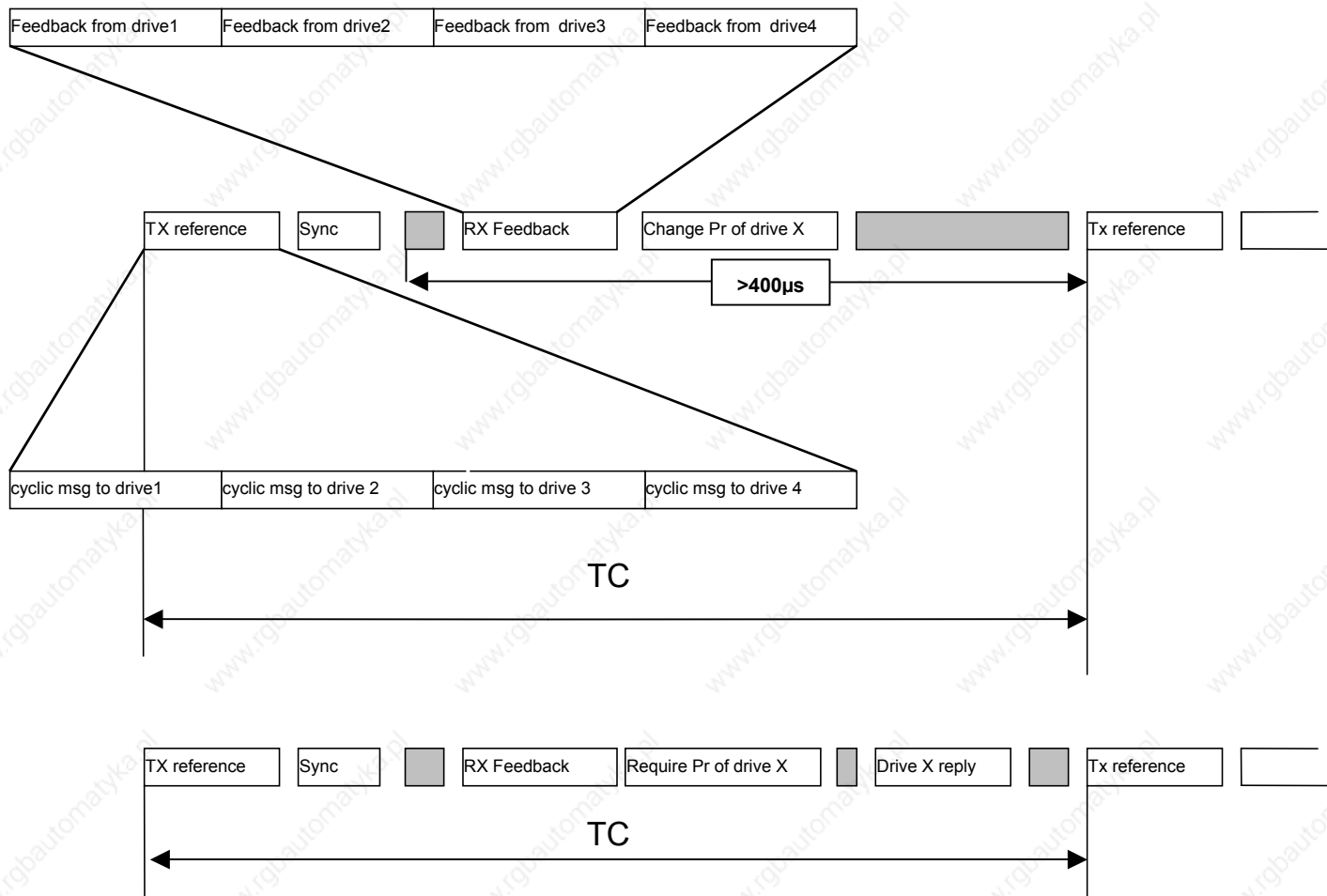

10.1.2 Description of the fields in communication mode

Write or parameter request message from the master to the drive

data write or request															
Data length	7 bytes														
Field Name	Cmd & Len					Data Address						Data			
Contents	5 bit command and 3 bit length					16 bit data address						32 bit data			
Identifier															
ID2	ID1	ID0	-	-	-	-	-	ID10	ID9	ID8	ID7	ID6	ID5	ID4	ID3
A2	A1	A0	X	X	X	X	X	0	A4	0	0	1	0	0	A3

A0:A4 drive slave address (Pr27+1), valid values 1..31.

Cmd & Len	Sub-field	Value	Meaning
	Cmd [0..4]	0	Read request
		1	Write
		2	SET bit
		3	RESET bit
		4	TOGGLE bit
		5 – 31	Not used
	Len [5..7]	0- 4	Number of significant bytes in the data field

Pr = Pr .OR. Data
Pr = Pr .AND. (.NOT.Data)
Pr = Pr .XOR. Data

Data Address

This is the address of the parameter interested in the operation (parameter number * 2).

The PLC instructions have the address from 8192 up to 8703.

The electronic cam0 table have the address from 4096 to 4609.

The electronic cam1 table have the address from 4610 to 5123.

The electronic cam2 table have the address from 5124 to 5637.

The electronic cam3 table have the address from 5638 to 6151.

Data

If the parameter is written, it contains the value of the parameter.

If one or more bits are modified, it contains the mask of the bits to be modified.

If the parameter is to be read, the field has no meaning.

If plc programme is written, it contains the instruction code (see the section *Serial interface*).

Response to a parameter request message from the drive to the master

Data reply															
Data length		5 byte													
Field Name		Addr & Spare						Data							
Contents		Pr27+1 (8bit)						32 bit reply data							
Identifier															
ID2	ID1	ID0	-	-	-	-	-	ID10	ID9	ID8	ID7	ID6	ID5	ID4	ID3
A2	A1	A0	X	X	X	X	X	0	A4	0	1	1	0	0	A3

A0:A4 drive slave address (Pr27+1), valid values 1..31.

Broadcast write parameter message from the master to the drive

Broadcast data write															
Data length		7 bytes													
Field Name		Cmd & Len						Data Address				Data			
Contents		5 bit command and 3 bit length						16 bit data address				32 bit data			
Identifier															
ID2	ID1	ID0	-	-	-	-	-	ID10	ID9	ID8	ID7	ID6	ID5	ID4	ID3
1	1	1	X	X	X	X	X	0	A4	1	0	0	0	1	1

Cmd & Len	Sub-field	Value	Meaning
	Cmd [0..4]	0	Not used
		1	Write
		2	SET bit
		3	RESET bit
		4	TOGGLE bit
		5 – 31	Not used
	Len [5..7]	0- 4	Number of significant bytes in the data field

Data Address

This is the address of the parameter interested in the operation (parameter number * 2).
The PLC instructions have the address from 8192 up to 8703.

Data

When the parameter is written, it contains the value of the parameter.

If one or more bits are modified, it contains the mask of the bits to be modified.

If plc programme is written, it contains the instruction code (see the section *Serial interface*).

Alarm message from the drive to the master

Error															
Data length	3 bytes														
Field Name	Addr							Error							
Contents	Pr27+1							Pr23							
Identifier															
ID2	ID1	ID0	-	-	-	-	-	ID10	ID9	ID8	ID7	ID6	ID5	ID4	ID3
A2	A1	A0	X	X	X	X	X	0	A4	0	1	0	0	0	A3

A0:A4 drive slave address (Pr27+1), valid values 1..31.

If the converter is in the alarm status, it will send this message on the bus (alarm 0 = no alarm).

10.1.3 Description of the fields Extended message set # 2

The extended message set 2 permits a memory area exchange between the master and the drive with both communication and real-time mode. The data exchange is synchronous: the data, transmitted from the master to the device, are stored in a temporary buffer; when the master sends the synchronous message to all the drives, each device copies the temporary buffer onto the writing block area and sends back the reading block area.

Block send message from the master to the drive

Block send															
Data length	8 bytes														
Field Name	Data														
Contents	64 bit of data														
Identifier															
ID2	ID1	ID0	-	-	-	-	-	ID10	ID9	ID8	ID7	ID6	ID5	ID4	ID3
A2	A1	A0	X	X	X	X	X	1	0	0	0	0	0	1	A3

A0:A3 drive slave address (Pr27+1), valid values 1..15.

Synchronism message from the master to the drive

Block sync															
Data length		0 bytes													
Field Name		No data													
Contents		No data													
Identifier															
ID2	ID1	ID0	-	-	-	-	-	ID10	ID9	ID8	ID7	ID6	ID5	ID4	ID3
0	0	0	X	X	X	X	X	1	0	0	0	0	0	0	0

Data received are stored from Pr80 to Pr83, and drive sends parameters from Pr84 to Pr87 by the following message:

Block reply message from drive to the master

Block reply															
Data length		8 bytes													
Field Name		Data													
Contents		64 bit of data													
Identifier															
ID2	ID1	ID0	-	-	-	-	-	ID10	ID9	ID8	ID7	ID6	ID5	ID4	ID3
A2	A1	A0	X	X	X	X	X	1	0	0	0	0	1	0	A3

A0:A3 drive slave address (Pr27+1), valid values 1..15.

Note 1: as for the “real time mode”, bit 41.9 is set to 1 every synchronism message receiving via SBCCAN.

Therefore, it is possible to check the communication status between Master and Slave via CAN bus through a simple pico-PLC program.

The pico-PLC code on the drive be as follows:

```

...
Ld 41.9
Out 41.5
Rst 41.9
...

```

If the check of the communication status between Master and Slave via CAN bus is implemented into the drive pico-PLC, the test is executed every 6.144 [ms] (i.e. minimum execution time of pico-PLC program) or multiples.

10.2 CANopen (C version)

The CANbus node must be set through Pr49 with values from 1 to 127.
Transmission speed depends on Pr31, Pr48 e b150.4 as the following table:

Pr48	Pr31≠15	Pr31=15	Pb150.4
0	125 kbps	1 Mbps	0
0	125 kbps	500 kbps	1
1	1 Mbps		
2	500 kbps		
3	250 kbps		
4	125 kbps		
5	50 kbps		
6	20 kbps		
7	10 kbps		

All changes in speed, address or function mode are activated using the b42.3 command or when the converter is powered on again.

An alternative to the SBCCAN protocol is CANopen (to be expressly requested when placing your order: the drive may only have one protocol at a time) with the following implementations and functions:

The following objects are available based on CANopen's Pre-defined Connection Set:

Objects	Function code	COB-Ids	Index
NMT object	0000	0x00	-
EMERGENCY objec	0001	0x81-0xff	0x1014
SDO (tx) object	1011	0x581-0x5ff	0x1200
SDO (rx) object	1100	0x601-0x67f	0x1200
NMT Error Control (Node guarding)	1100	0x701-0x77f	0x100c- 0x100d

NMT object:

NMT state machine (DS301)

NMT Error Control & Boot Up Protocol:

- Boot Up
- Node Guarding – 39.14=1 for each receipt

EMERGENCY object :

Below is a description of emergency object implementation:

Emergency message from Drive to master

Emergency message															
Data length			8 byte												
Field Name			Error code		Err. Reg			Drive address			Data				
Contents			16 bit code		8 bit error			8 bit address			32 bit reply data				
Identifier															
ID2	ID1	ID0	-	-	-	-	-	ID10	ID9	ID8	ID7	ID6	ID5	ID4	ID3
A2	A1	A0	X	X	X	X	X	0	0	0	1	A6	A5	A4	A3

A0:A6 Drive address (Pr49), valid values 1..127.

An alarm message and two pop-up messages are available for this object, and each of these can be enabled or disabled by setting the appropriate commands.

- Alarm message (enabled if b150.1=1)
- Target position reached (enabled if b150.5=1)
- Value motor captured (enabled if b150.7=1)

The alarm message, if enabled, is sent each time that the current alarm status (Pr[23]) changes, so that when a new alarm occurs (or when the alarms are reset) the value 0x01 is sent to the field Err.Reg, and the least significant byte of the Data field will contain the drive's alarm code.

The field Error Code will contain a specific code based on the different drive alarm:

- Er01 (over voltage) : 0x3210
- Er02 (under voltage) : 0x3220
- Er03 (over current) : 0x2340
- Er04 (encoder break) : 0x7310
- Er05 (over temperature motor) : 0xff07
- Er06 (over temperature drive): 0x4310
- Er07 (aux trip 1) : 0xff00
- Er08 (aux trip 2) : 0xff01
- Er10 (checksum PLC) : 0x6310
- Er11 (checksum Parameter): 0x6310
- Er14 (braking resistance alarm) : 0x7113
- Er15 (default Parameter) : 0x6320
- Er17 (calibration alarm) : 0x5210
- Er22 (over temperature ambient): 0x4110
- Er24 (over current braking): 0x7112
- Er25 (speed feedback error) : 0xff0e
- Er30 (hardware data memory) : 0x5530

When alarms are reset with b99.10, Error code will be 0x0000 .

Two additional pop-up message not related to alarms can be enabled using command bits, and in this case the Err.Reg field will contain 0x00, while Error code will be 0xff05 for the target position reached message and 0xff06 for the value drive captured message. The Data field, in addition to the drive address, will, in the first case, contain the position reached by the motor and, in the second case, the captured position of the motor on the positive front of the input IN1.

The target position reached message is generated when the motor, after the target position is changed (in operating mode 13 b150.0=1, in operating mode 14 Pr102 not zero), will go to the target position at less than a tolerance set in Pr55 for at least a time of Pr88*2.048msec. When this message is enabled, the parameters b70.4, Pr55 and Pr88 are reserved for this task and are no longer available for their standard functions (servo error window and PLC program).

A user message can be sent by setting Pb70.12 to 1. In this case, Error Code will be 0xFF09 and the Data field will contain the value in Pr152:153. b70.12 will be reset to 0 once the message has been sent.

SDO(tx/rx) object

Below is a list of the objects in the device dictionary:

Object dictionary:

Index

0x1000 : Device type (301)	RO
0x1001 : Error register	RO
0x1014 : COB-ID emergency obj	RO
0x1018 : Identity	RO
0x100c : Guard time	RO
0x100d : Life time factor	RO
0x1200 : Server SDO parameters	RO
0x2000 : Parameters area	RW
0x2001 : Parameters area set bit	W
0x2002 : Parameters area reset bit	W
0x2003 : Pico-PLC area	RW
0x2004 : I table area CAM0 (0..254)	RW
0x2005 : II table area CAM0 (255..256)	RW
0x2006 : I table area CAM1 (0..254)	RW
0x2007 : II table area CAM1 (255..256)	RW
0x2008 : I table area CAM2 (0..254)	RW
0x2009 : II table area CAM2 (255..256)	RW
0x200A : I table area CAM3 (0..254)	RW
0x200B : II table area CAM3 (255..256)	RW

As a general rule, sub_index 0 of indexes 0x2000..0x2002 represents the number of the sub_indexes available, and the subsequent (1..N) sub_indexes represent the parameter number concerned +1.

Sub_index 1 → Pr[0]

Sub_index 2 → Pr[1]

....

Sub_index n+1 → Pr[n]

Example of device memory access by SDO:

Write Pr80 to the drive:

You will need to write the object by SDO with index-sub_index 0x2000-0x51 (80+1).

If the number of bytes written is greater than two, the operation will also change the parameter Pr81.

Read Pr60 from the drive:

You will need to read the object by SDO with index-sub_index 0x2000-0x3d (60+1). The value returned will have a length of 4 bytes, the most significant of which will contain Pr61. If they are not needed, they can simply be discarded.

Set bit 4 of Pr40:

You will need to write the object by SDO with index-sub_index 0x2001-0x20 (40+1) with the value (0x0010) that represents in binary the bits involved in the operation, in our case bit 4.

Reset bits 4 and 5 of Pr40:

You will need to write the object by SDO with index-sub_index 0x2002-0x29 (40+1) with the value (0x0030) that represents in binary the bits involved in the operation, in our case bits 4 and 5.

Write bytes 0 and 1 of the pico-PLC area:

You will need to write the object by SDO with index-sub_index 0x2003-0x01 (0+1) with the value corresponding to the operating code of the instruction to add. For example, the instruction LD 90.0 requires the value 0x00 to be written in byte 0 and 0x5a in byte 1.

In addition to the objects described above, other objects are implemented based on CANopen's Predefined Connection Set, although these are not found in the object dictionary. These objects can be useful in accessing drive movement parameters.

PDO (tx/rx) object

PDO2 (tx/rx) object :

A protocol for parameter access, pico-PLC instructions, and drive cam table is implemented by exchanging the 8+8 read/write bytes of the PDO2, which, when the master receives the message PDO2 rx, interprets the contents of the first 7 bytes in accordance with the following format:

Acyclic data write message or parameter request from master to drive (PDO 2)

Acyclic data write or request															
Data length			7 byte												
Field Name			Cmd & Len				Data Address				Data				
Contents			5 bit command and 3 bit length				16 bit data address				32 bit data				
Identifier															
ID2	ID1	ID0	-	-	-	-	-	ID10	ID9	ID8	ID7	ID6	ID5	ID4	ID3
A2	A1	A0	X	X	X	X	X	0	1	1	0	A6	A5	A4	A3

A0:A6
Data

Drive movement address (Pr49), valid values 1..127.
For data writing, the field will contain the value of the parameter.
For bit change, the field will contain the mask of the bits to change.
For data reading, the field is insignificant.

For pico-PLC writing, it will contain the operating code of the instruction (see *Serial interface*).

Data Address This field is the address of the parameter involved in the operation (parameter number * 2).

The PLC instructions have the address from 8192 up to 8703.

The electronic cam0 table have the address from 4096 to 4609.

The electronic cam1 table have the address from 4610 to 5123.

The electronic cam2 table have the address from 5124 to 5637.

The electronic cam3 table have the address from 5638 to 6151.

Cmd & Len	Sub-field	Value	Meaning
	Cmd [0..4]	0	Read request
		1	Write
		2	SET bit Pr = Pr .OR. Data
		3	RESET bit Pr = Pr .AND. (.NOT.Data)
		4	TOGGLE bit Pr = Pr .XOR. Data
		5 – 31	Not use
	Len [5..7]	0- 4	Number of significant bytes in the data field

Acyclic response to a parameter request message from drive to master (PDO 2)

Data reply															
Data length		8 bytes													
Field Name		Addr & Spare				Data address				Data					
Contents		Pr27				16 address				32 bit reply data					
Identifier															
ID2	ID1	ID0	-	-	-	-	-	ID10	ID9	ID8	ID7	ID6	ID5	ID4	ID3
A2	A1	A0	X	X	X	X	X	0	1	0	1	A6	A5	A4	A3

A0:A6 Drive address (Pr49), valid values 1..127.

PDO3 (tx) object :

This is used to generate a message with the data required to implement a reserved function.

PDO4 (tx/rx) object :

In this case, a parameter exchange function is implemented with the movement related to the logic functions managed by pico-PLC. In fact, for each transmission of PDO4 rx from the master to the drive node, the bytes contained in the message are interpreted as follows:

Parameter Pr80..83 write message from master to drive (PDO 4 rx)

Data receive																	
Data length		8 bytes															
Field Name		Pr80				Pr81				Pr82				Pr83			
Contents		16 bit value				16 bit value				16 bit value				16 bit value			
Identifier																	
ID2	ID1	ID0	-	-	-	-	-	ID10	ID9	ID8	ID7	ID6	ID5	ID4	ID3		
A2	A1	A0	X	X	X	X	X	1	0	1	0	A6	A5	A4	A3		

A0:A6 Slave drive address (Pr49), valid values 1..127.

The bytes of the message are written to the corresponding parameters only if the function described is enabled by setting bit b99.5 to 1, and is done immediately prior to the next pico-PLC scan cycle (every 6.144 msec) from the reception of the PDO4 rx message.

In much the same way as described above, the parameters Pr84..87 are sent through PDO4 tx by the slave to the master with the following format:

Parameter Pr84..87 read message from master to drive (PDO 4 rx)

Data send																	
Data length		8 bytes															
Field Name		Pr84				Pr85				Pr86				Pr87			
Contents		16 bit value				16 bit value				16 bit value				16 bit value			
Identifier																	
ID2	ID1	ID0	-	-	-	-	-	ID10	ID9	ID8	ID7	ID6	ID5	ID4	ID3		
A2	A1	A0	X	X	X	X	X	1	0	0	1	A6	A5	A4	A3		

The bytes of the message containing the parameters Pr84...87 are sent to the master only if the function described is enabled by setting bit b99.5 to 1, and is done every Pr161 pico-PLC scan cycles (every 6,144 msec). If Pr161 is set to zero, the bytes are not sent even if b99.5=1. The data is sent when the pico-PLC program scan is complete.

The exchange structure implemented by the PDO4 allows access to the parameters Pr80..87 that do not have a predefined function in the converter but can be processed and interpreted with different functions and meanings according to the logic implemented in the pico-PLC program.

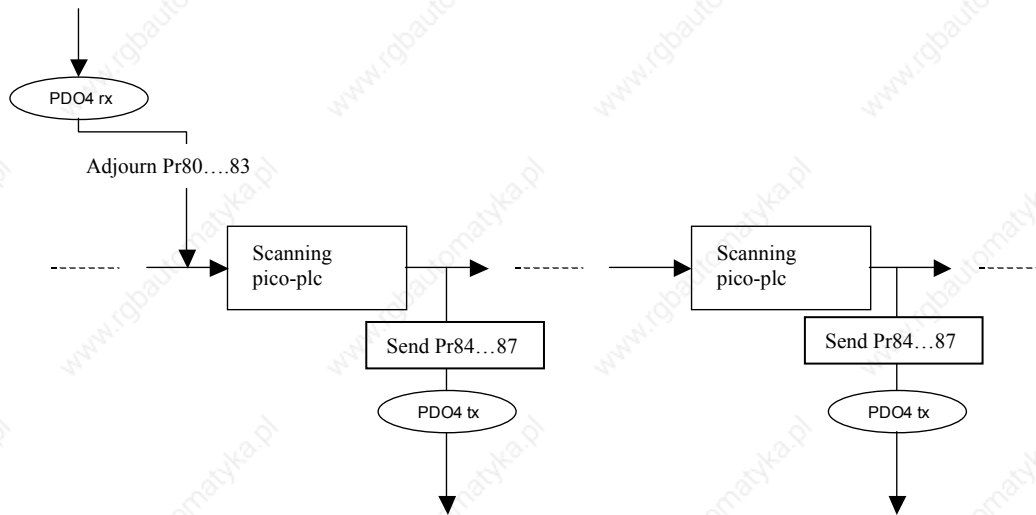

PDO1 (tx/rx) object :**Realtime Mode (Pr31 = 15):**

In the same way as for the SBCCAN protocol, a real-time mode has been implemented (operating mode 15) which, for CANopen networks, uses PDO1 (rx/tx) for cyclical data exchange and the SYNC message for synchronizing the position loops. The message COB-IDs are different from SBCCAN execution for the purposes of compatibility with CANopen networks.

Cyclic message from master to drive (PDO1 rx)

Cyclic data																
Data length	8/6/4 bytes															
Field Name	Data															
Contents	position ref. 32 bits							speed ref. 16 bits				Pr102				
Identifier																
ID2	ID1	ID0	-	-	-	-	-	ID10	ID9	ID8	ID7	ID6	ID5	ID4	ID3	
A2	A1	A0	X	X	X	X	X	0	1	0	0	A6	A5	A4	A3	

A0:A6 Slave drive address (Pr49), valid values 1..127.

Pr102 is used as a command and must be managed by the pico-PLC.

Based on the length of the message, the data received is interpreted in the following way.

Data length			
8	Position reference (4 byte)	Speed reference (2 byte)	Pr102 (2 byte)
6	Position reference (4 byte)	Pr102 (2 byte)	
4	Speed reference (2 byte)	Pr102 (2 byte)	

Synchronism message from master to drive

Synchronism message															
Data length	0 bytes														
Field Name															
Contents															
Identifier															
ID2	ID1	ID0	-	-	-	-	-	ID10	ID9	ID8	ID7	ID6	ID5	ID4	ID3
0	0	0	X	X	X	X	X	0	0	0	1	0	0	0	0

Upon receipt of the sync message, each drive activates the speed and position references and saves the current motor position. If b150.2=1, the drive responds with a message "cyclic reply".

Cyclic reply message from device to Master (PDO1 tx)

Cyclic reply																
Data length	8 bytes															
Field Name	Addr				Data				Status				spare			
Data	Pr49 (1 byte)				motor position 32 bits				Pr103(16bit)				reserved			
Identifier																
ID2	ID1	ID0	-	-	-	-	-	ID10	ID9	ID8	ID7	ID6	ID5	ID4	ID3	
A2	A1	A0	X	X	X	X	X	0	0	1	1	A6	A5	A4	A3	

NOTE: The other features of SBCCan are no more available in this release.

The use of CANopen involves the reduction of the number of the free parameter.

See the next table:

PAR	MIN	MAX	DEF	DESCRIPTION
152	-2^{31}	2^{31}		CANopen user emgy message
153	-2^{31}	2^{31}		CANopen user emgy message
161	-2^{31}	2^{31}		CANopen user emgy message

b39.14 CANopen Node Guard watchdog.

10.3 CANopen dsp402 (D version)

The CANbus node must be set through Pr49 with values from 1 to 127.
Transmission speed depends on Pr31, Pr48 e b150.4 as the following table:

Pr48	Pr31≠15	Pr31=15	Pb150.4
0	125 kbps	1 Mbps	0
0	125 kbps	500 kbps	1
1	1 Mbps		
2	500 kbps		
3	250 kbps		
4	125 kbps		
5	50 kbps		
6	20 kbps		
7	10 kbps		

All changes in speed, address or function mode are activated using the b42.3 command or when the converter is powered on again.

In the CANopen implementation of drive an SDO channel is available (standard cob-id) with a changeable timeout value mapped at the index 0x2020 as Unsigned 16 with a default value of 5000 (1 unit 1.024 msec). Both standard guarding protocols are available , Node guarding and heartbeat (the two cannot exist in the same time) Heartbeat is activated when a producer heartbeat time is set different from 0. Three PDO channels PDO 1,2,4 from the predefined standard connection set are available PDO 1 and 2 are serviced by a cyclic routine executed every 2.048 msec and they are remappable (elements of 2 or 4 bytes can be mapped) the RTR is allowed event time and inhibit time are active they can handle synchronous requests serviced every 2.048 msec or they can be handled as event driven.

PDO 4 is the PDO channel used for strictly realtime operation as controlling motor trajectory or position loop (the PDO is synchronous type 1) no RTR is allowed and a restricted set of parameters can be mapped , in particular:

PDO 4 rx : [0x6040] control word
 [0x60c1][1] position reference in counts
 [0x60c1][2] velocity reference in counts/sec
 [0x60c1][3] velocity reference in rpm

PDO 4 tx : [0x6041] status word
 [0x6063] position feedback in counts
 [0x6064] position feedback in counts (normally in user unit in this case as well in counts)
 [0x2060] Word composed with digital input and aux analog input .
 b0: In0
 b1: In1
 b2: In2
 b3: In3
 b4..b15 Analog input aux.

Life guarding protocol is implemented and can be activated writing life time factor and guard time besides a missing guarding event ,life guarding protocol can be triggered by a missing sync (if b271.8=1) or a bus-off condition. In any case state machine present state of ds301 communication can be changed according to what is set in the object 0x1029 'error behaviour' (0 enter pre-operational , 1 no change , 2 stop).

Note NMT commands are handled every 1.024 msec, so subsequent commands should be sent to the drive not closer than 1.204 msec including broadcast NMT commands.

10.3.1 Dictionary object summary of ds301 in drive

[0x1000] : device type
 [0x1001] : error register
 [0x1005] : sync cob-id
 [0x1006] : communication cycle period
 [0x100c] : guard time
 [0x100d] : life time factor
 [0x1014] : Cob-Id Emergency object
 [0x1017] : Producer heartbeat time
 [0x1018] : Identity object
 [0x1029] : Error behaviour
 [0x1200] : SDO server parameters
 //pdo
 [0x1400] : PDO 1 rx communication parameters
 [0x1401] : PDO 2 rx communication parameters
 [0x1403] : PDO 4 rx communication parameters
 [0x1600] : PDO 1 rx mapping parameters
 [0x1601] : PDO 2 rx mapping parameters
 [0x1603] : PDO 4 rx mapping parameters
 [0x1800] : PDO 1 tx communication parameters
 [0x1801] : PDO 2 tx communication parameters
 [0x1803] : PDO 4 tx communication parameters
 [0x1a00] : PDO 1 tx mapping parameters
 [0x1a01] : PDO 2 tx mapping parameters
 [0x1a03] : PDO 4 tx mapping parameters
 //manufacturer
 [0x2000] : parameters'array 0..254 read write access
 [0x2001] : parameters'array 254..NR_PAR read write access
 [0x2002] : parameters'array 0..254 set bit access
 [0x2003] : parameters'array 254..NR_PAR set bit access
 [0x2004] : parameters'array 0..254 reset bit access
 [0x2005] : parameters'array 254..NR_PAR reset bit access
 [0x2006] : pico-plc area first 254 instructions
 [0x2007] : pico-plc area last 2 instructions
 [0x2008] : CAM 1 table first 254 points read write access
 [0x2009] : CAM 1 table first last 3 points read write access

- [0x200a] : CAM 2 table first 254 points read write access
- [0x200b] : CAM 2 table first last 3 points read write access
- [0x200c] : CAM 3 table first 254 points read write access
- [0x200d] : CAM 3 table first last 3 points read write access
- [0x200e] : CAM 4 table first 254 points read write access
- [0x200f] : CAM 4 table first last 3 points read write access

- [0x2020] : SDO timeout
- [0x2060] : digital and analog input
- [0x2063] : auxiliary encoder synchronous reading (data type: I32)

10.3.2 Dictionary object summary of dsp402 in drive

[0x6007] 'Abort connection option code': with the following available values

0: No action

1: Alarm (alarm MISSING_SYNC_TRIP (Er16) if sync is missing when $b271.8=1$ the sync signal interval exceeds the 120% of the nominal sync cycle lasting time of index 0x1006 communication cycle period the regularity of sync signal is checked with a resolution of 2.048 msec.

(If the node does not receive the guarding message before its lifetime an ABORT_CONN_TRIP (Er13)) is generated.

2: disable voltage

3: quick stop

[0x6040] 'Control word':

[0x6041] 'Status word':

[0x605a] 'Quick stop option code': valid values 0,1,2,5,6

[0x605b] 'Shut down option code': valid values 0,1

[0x605c] 'Disable operation option code': valid values 0,1

[0x605e] 'Fault reaction option code': valid values 0,1,2.

[0x6060] 'Mode of operation': valid values 1 (om201), 6 (om200), 7 (om202), -1(om11),-2 (om13), -3 (om14)

[0x6061] 'Modes of operation display': see the previous.

[0x6063] 'position actual value (counts)': If read by mean of SDO or mapped on PDO 1 or 2 returns the value of position feedback in counts from pr[132:133] if mapped on PDO 4 returns the value of the position feedback at the sync signal.

[0x6064] 'position actual value (units)': If read by mean of SDO or mapped on PDO 1 or 2 returns the value in counts of position feedback pr[132:133] transformed in user units by mean of position factor if mapped on PDO 4 returns the value of the position feedback at the sync signal in counts (the algorithm of interpolated mode does not support factor group).

[0x6065] 'Following error window': it is converted in counts by mean of position factor then set in SERVO1 (pr[140:141]) the parameters is used to test following error. The parameters of SERVO1 are changed by the firmware only if in remote mode.

[0x6066] 'Following error timeout': resolution of 1.024 msec per unit

- [0x6067] 'Position window': in user units converted by mean of position factor and compared with the motor position to check if target reached in profile position and interpolated position modes.
- [0x6068] 'Position window time': resolution of 1.024 msec per unit
- [0x607a] 'Target position': in user units converted by mean of position factor and used in profile position mode (in this mode some elements of CAM tab 0 are used as spare memory and so affected by changes).
- [0x607c] 'Home offset': in position units converted by position factor
- [0x6081] 'profile velocity': profile velocity in profile position mode (in counts/sec or RPM depending on unit selection (standard or not) with b272.1)
- [0x6083] 'profile acceleration': acceleration of profile in profile position mode (in counts/sec² or ms/kRPM depending on unit selection (standard or not) with b272.1)
- [0x6084] 'profile deceleration': deceleration of profile in profile position mode (in counts/sec² or ms/kRPM depending on unit selection (standard or not) with b272.1)
- [0x6085] 'quick stop deceleration': deceleration in quick stop action
- [0x6086] 'Motion profile type': valid values 0.
- [0x6093][1] 'Position factor': Numerator position factor
- [0x6093][2] 'Position factor': Denominator position factor
- [0x6094][1] 'Velocity encoder factor': Numerator velocity factor
- [0x6094][2] 'Velocity encoder factor': Denominator velocity factor
- [0x6097][1] 'Acceleration factor': Numerator acceleration factor
- [0x6097][2] 'Acceleration factor': Denominator acceleration factor
- [0x6098] 'Homing method': all standard values available.
- [0x6099][1] 'Homing speeds': searching sensor velocity (in counts/sec or RPM depending on unit selection (standard or not) with b272.1)
- [0x6099][2] 'Homing speeds': searching index velocity (in counts/sec or RPM depending on unit selection (standard or not) with b272.1)
- [0x609a] 'Homing acceleration': acceleration homing (in counts/sec² or ms/kRPM depending on unit selection (standard or not) with b272.1)
- [0x60c0] 'Interpolation sub mode selection': valid values 0(linear interpolation), -1(cubic interpolation with position and velocity) , -2 (cubic interpolation with position)
- [0x60c1][1] 'Interpolation data record': INTEGER32 interpolator position reference
- [0x60c1][2] 'Interpolation data record': INTEGER32 interpolator velocity reference in counts/sec
- [0x60c1][3] 'Interpolation data record': INTEGER32 interpolator velocity reference in RPM
- [0x6502] 'Supported drive modes': see (see 0x6060)
- [0x6504] 'Drive Manufacturer': "Parker Hannifin div. SBC Italy"
- [0x6505] 'http drive catalog address': "http://www.sbcelettronica.com http://www.parker-eme.com"

Following modes of operation of dsp 402 are implemented beside the device control state machine:

Homing mode

Profile position mode

Interpolated position mode

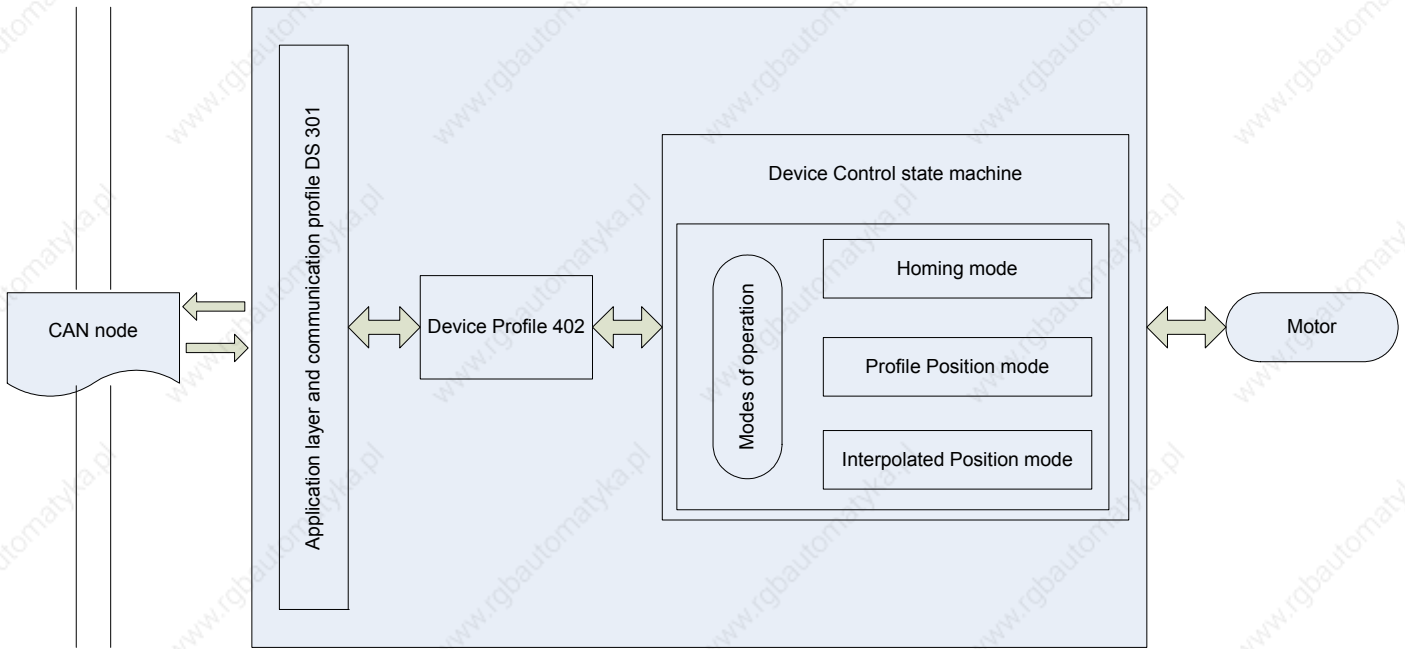

Here by the schematic of device control with controlword e statusword

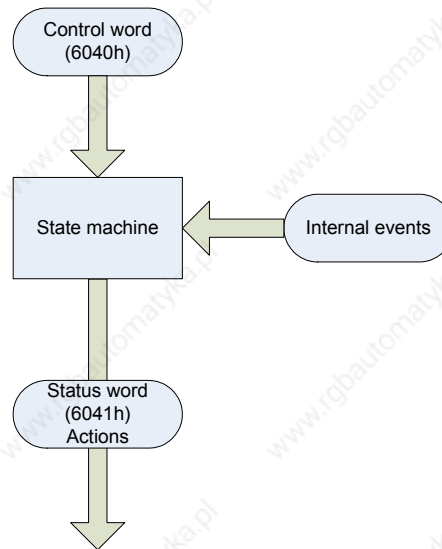

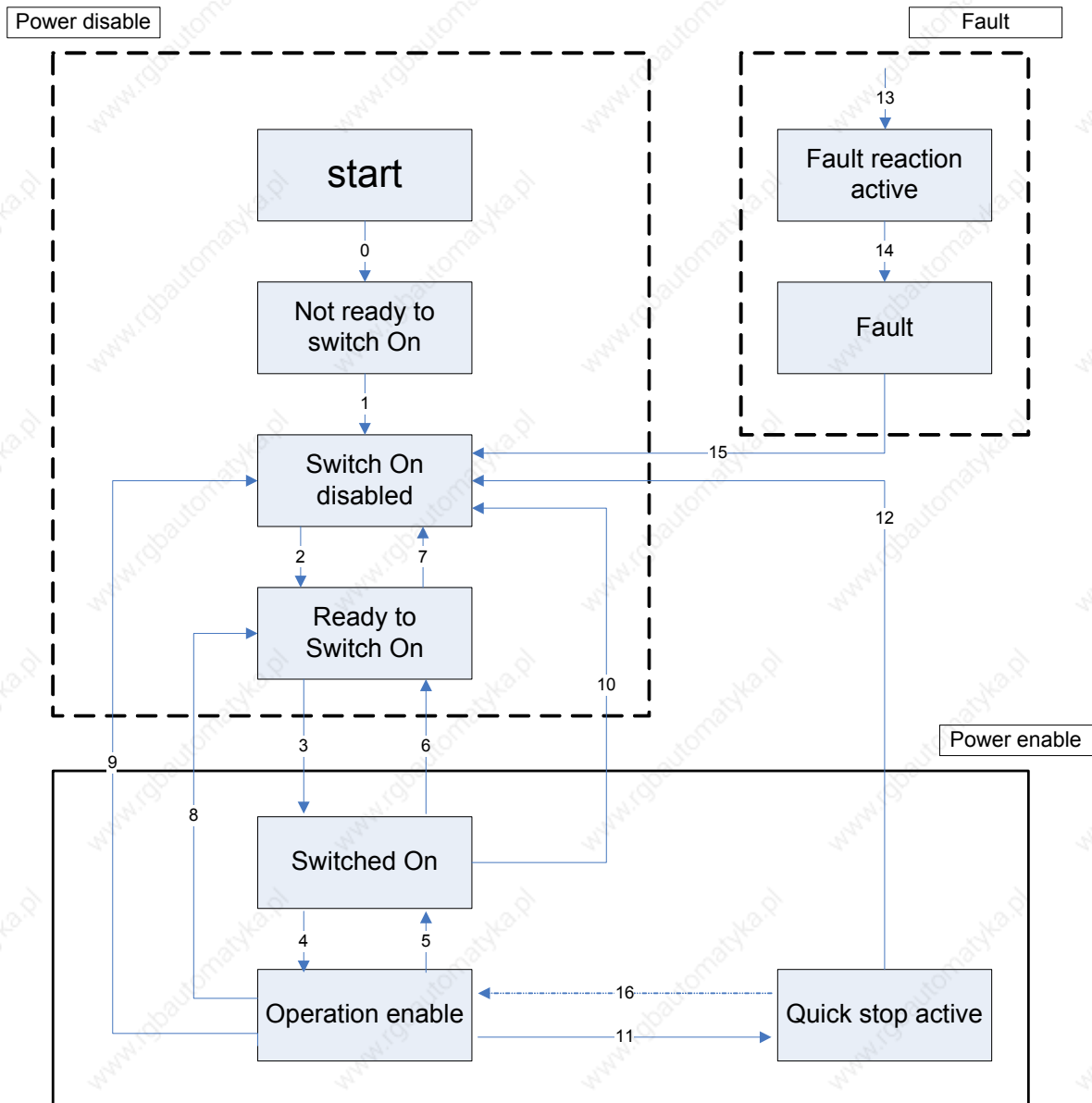

If I²t current clamping is active bit 11 of the statusword rises.

10.3.2.1 Object 6040h: Controlword

The *controlword* consist of bits for:

- the controlling of the state,
- the controlling of operating modes and
- manufacturer specific options.

OBJECT DESCRIPTION

INDEX	6040h
Name	Controlword
Object Code	VAR
Data Type	UNSIGNED16
Category	Mandatory

ENTRY DESCRIPTION

Access	rw
PDO Mapping	Possible
Value Range	UNSIGNED16
Default Value	No

DATA DESCRIPTION The bits of the *controlword* are defined as follows:

15	11	10	9	8	7	6	4	3	2	1	0
Manufacturer specific	Reserved	Halt	Fault reset	Operation mode specific	Enable operation	Quick stop	Enable voltage	Switch on			
O	O	O	M	O	M	M	M	M			
MSB				LSB							

0 -Optional

M -Mandatory

BITS 0 – 3 AND 7:

Device control commands are triggered by the following bit patterns in the *controlword*:

Command	Bit of the <i>controlword</i>					Transitions
	Fault reset	Enable operation	Quick stop	Enable voltage	Switch on	
Shutdown	0	X	1	1	0	2,6,8
Switch on	0	0	1	1	1	3*
Switch on	0	1	1	1	1	3**
Disable voltage	0	X	X	0	X	7,9,10,12
Quick stop	0	X	0	1	X	7,10,11
Disable operation	0	0	1	1	1	5
Enable operation	0	1	1	1	1	4,16
Fault reset		X	X	X	X	15

Table 4: Device control commands (bits marked X are irrelevant, * ... In the state SWITCHED ON the drive executes the functionality of this state., ** ... It exists no functionality in the state SWITCHED ON. The drive does not do any in this state.)

BITS 4, 5, 6 AND 8:

These bits are operation mode specific. The description is situated in the chapter of the special mode. The following table gives an overview:

Bit	Operation mode		
	Velocity mode	Profile velocity mode	Profile torque mode
4	rfg enable	reserved	reserved
5	rfg unlock	reserved	reserved
6	rfg use ref	reserved	reserved
8	Halt	Halt	Halt

Table 5: Mode specific bits in the *controlword*

BITS 9, 10:

These bits are reserved for further use. They are inactive by setting to zero. If they have no special function, they must be set to zero.

BITS 11, 12, 13, 14 AND 15:

These bits are manufacturer specific.

10.3.2.2 Object 6041_n: Statusword

The *statusword* indicates the current state of the drive. No bits are latched. The *statusword* consist of bits for:

- the current state of the drive,
- the operating state of the mode and
- manufacturer specific options.

OBJECT DESCRIPTION

INDEX	6041h
Name	Statusword
Object Code	VAR
Data Type	UNSIGNED16
Category	Mandatory

ENTRY DESCRIPTION

Access	ro
PDO Mapping	Possible
Value Range	UNSIGNED16
Default Value	No

Bit	Description	M /O
0	Ready to switch on	M
1	Switched on	M
2	Operation enabled	M
3	Fault	M
4	Voltage enabled	M
5	Quick stop	M
6	Switch on disabled	M
7	Warning	O
8	Manufacturer specific	O
9	Remote	M
10	Target reached	M
11	Internal limit active	M
12 - 13	Operation mode specific	O
14 - 15	Manufacturer specific	O

BITS 0 – 3, 5 AND 6:

The following bits indicate the status of the device:

Value (binary)	State
xxxx xxxx x0xx 0000	Not ready to switch on
xxxx xxxx x1xx 0000	Switch on disabled
xxxx xxxx x01x 0001	Ready to switch on
xxxx xxxx x01x 0011	Switched on
xxxx xxxx x01x 0111	Operation enabled
xxxx xxxx x00x 0111	Quick stop active
xxxx xxxx x0xx 1111	Fault reaction active
xxxx xxxx x0xx 1000	Fault

Table 7: Device state bits (x ... irrelevant for this state)

BIT 4: VOLTAGE ENABLED

High voltage is applied to the drive when this bit is set to 1.

BIT 5: QUICK STOP

When reset, this bit indicates that the drive is reacting on a quick stop request. Bits 0, 1 and 2 of the *statusword* must be set to 1 to indicate that the drive is capable to regenerate. The setting of the other bits indicates the status of the drive (e.g. the drive is performing a quick stop as result of a reaction to a non-fatal fault. The fault bit is set as well as bits 0, 1 and 2).

BIT 7: WARNING

A drive warning is present if bit 7 is set. The cause means no error but a state that has to be mentioned, e.g. temperature limit, job refused. The status of the drive does not change. The cause of this warning may be found by reading the fault code parameter. The bit is set and reset by the device.

BIT 8:

This bit may be used by a drive manufacturer to implement any manufacturer specific functionality.

BIT 9: REMOTE

If bit 9 is set, then parameters may be modified via the CAN-network, and the drive executes the content of a command message. If the bit remote is reset, then the drive is in local mode and will not execute the command message. The drive may transmit messages containing valid actual values like a *position actual value*, depending on the actual drive configuration. The drive will accept accesses via SDO in local mode.

BIT 10: TARGET REACHED

If bit 10 is set by the drive, then a set-point has been reached. The set-point is dependent on the operating mode. The description is situated in the chapter of the special mode. The change of a target value by software alters this bit.

If *quick stop option code* is 5, 6, 7 or 8, this bit must be set, when the quick stop operation is finished and the drive is halted.

If halt occurred and the drive has halted then this bit is set too.

BIT 11: INTERNAL LIMIT ACTIVE

This bit set by the drive indicates, that an internal limitation is active: I^2t current clamping is active.

BIT 12 AND 13:

These bits are operation mode specific. The description is situated in the chapter of the special mode. The following table gives an overview:

Bit	Operation mode					
	vl	pp	pv	tq	hm	ip
12	reserved	Set-point acknowledge	Speed	reserved	Homing attained	ip mode active
13	reserved	Following error	Max slippage error	reserved	Homing error	reserved

Table 8: Mode specific bits in the *statusword*

BIT 14 AND 15:

These bits may be used by a drive manufacturer to implement any manufacturer specific functionality.

10.3.2.3 Object 605B_n: Shutdown option code

The parameter *shutdown option code* determines what action should be taken if there is a transition OPERATION ENABLE ⇒ READY TO SWITCH ON.

OBJECT DESCRIPTION

INDEX	605Bh
Name	Shutdown option code
Object Code	VAR
Data Type	INTEGER16
Category	Optional

ENTRY DESCRIPTION

Access	rw
PDO Mapping	No
Value Range	INTEGER16
Default Value	0

DATA DESCRIPTION

Value	Description
-32768 ... -1	manufacturer specific
0	Disable drive function
1	Slow down with slow down ramp; disable of the drive function
2 ... 32767	reserved

10.3.2.4 Object 605Ch: Disable operation option code

The parameter *disable operation option code* determines what action should be taken if there is a transition OPERATION ENABLE ⇒ SWITCHED ON. OBJECT DESCRIPTION

INDEX	605Ch
Name	Disable operation option code
Object Code	VAR
Data Type	INTEGER16
Category	Optional

ENTRY DESCRIPTION

Access	rw
PDO Mapping	No
Value Range	INTEGER16
Default Value	1

DATA DESCRIPTION

Value	Description
-32768 ... -1	manufacturer specific
0	Disable drive function
1	Slow down with slow down ramp and then disabling of the drive function
2 ... 32767	reserved

10.3.2.5 Object 605A_n: Quick stop option code

The parameter *quick stop option code* determines what action should be taken if the Quick Stop Function is executed.

OBJECT DESCRIPTION ENTRY DESCRIPTION

INDEX	605Ah
Name	Quick stop option code
Object Code	VAR
Data Type	INTEGER16
Category	Optional

Access	rw
PDO Mapping	No
Value Range	INTEGER16
Default Value	2

DATA DESCRIPTION

Value	Description
0	disable drive function
1	slow down on slow down ramp
2	slow down on quick stop ramp
5	slow down on slow down ramp and stay in QUICK STOP
6	slow down on quick stop ramp and stay in QUICK STOP

10.3.2.6 Object 605E_n: Fault reaction option code

The parameter *Fault reaction option code* determines what action should be taken if a fault occurs.

OBJECT DESCRIPTION

INDEX	605E _n
Name	Fault reaction option code
Object Code	VAR
Data Type	INTEGER16
Category	Optional

ENTRY DESCRIPTION

Access	rw
PDO Mapping	No
Value Range	INTEGER16
Default Value	2

DATA DESCRIPTION

Value	Description
-32768 ... -1	manufacturer Specific
0	disable drive, motor is free to rotate
1	slow down on slow down ramp
2	slow down on quick stop ramp

10.3.2.7 Object 6060_n: Modes of operation

The parameter *modes of operation* switches the actually chosen operation mode.

OBJECT DESCRIPTION

INDEX	6060h
Name	Modes of operation
Object Code	VAR
Data Type	INTEGER8
Category	Mandatory

ENTRY DESCRIPTION

Access	rw
PDO Mapping	Possible
Value Range	INTEGER8
Default Value	No

DATA DESCRIPTION

Value	Description
1	Profile Position Mode
6	Homing Mode
7	Interpolated Position Mode

NOTE A read of *modes of operation* shows only the value of *modes of operation*. The actual mode of the drive is reflected in the object *modes of operation display*. It may be changed by writing to *modes of operation*.

10.3.2.8 Object 6061_n: Modes of operation display

The *modes of operation display* shows the current mode of operation. The meaning of the returned value corresponds to that of the *modes of operation* option code (index 6060_n).

OBJECT DESCRIPTION

INDEX	6061h
Name	Modes of operation display
Object Code	VAR
Data Type	INTEGER8
Category	Mandatory

ENTRY DESCRIPTION

Access	ro
PDO Mapping	Possible
Value Range	INTEGER8
Default Value	No

DATA DESCRIPTION Same as for object 6060_h *modes of operation*.

NOTE The actual mode is reflected in the *modes of operation display* (index 6061_h), and not in the *modes of operation* (index 6060_h).

10.3.3 Functional description

10.3.3.1 Modes of operation function

The device behaviour depends on the activated modes of operation.

It is possible to implement different device modes. Since it is not possible to operate the modes in parallel, the user is able to activate the required function by selecting a mode of operation. An example of exclusive functions are those for position and torque control, which can only control one variable at any one time. The variables can perform at most a limited function. Such hybrids are regarded as the particular characteristics of a mode of operation. Position control operation and encoder profile support can be active at the same time, for example. Consequently encoder profile support is not regarded as a mode of operation.

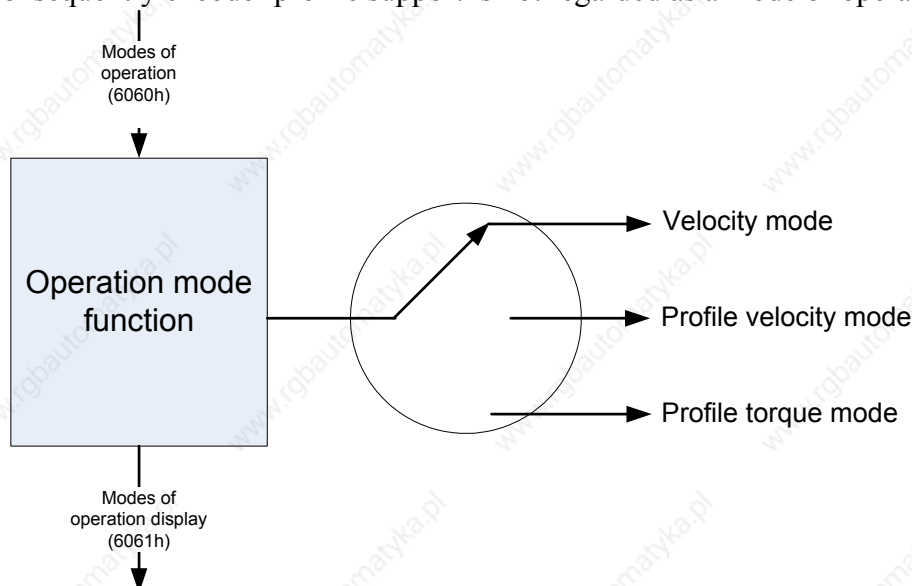

10.3.4 Homing mode (operative mode 200)

In homing mode (Pr31=200) all the standard methods are available the index is referred to the feedback C encoder input track Z, it is also possible to refer the index to the absolute (in the shaft revolution) position of zero of the position feedback (resolver, SinCos absolute etc) setting the homing method to the same absolute value as for track Z indexing but negative. In this case the presetting of the position counters on the index is completed without axis movement.

For homing procedures 3 predefined bit are used

- b91.2 : home switch
- b91.3 : Left limit switch
- b91.4 : Right limit switch

The active level of the 3 bit can be inverted by mean of a bit mask mapped at index 0x2021 as U16 where bit 2,3,4 are processed by a XOR operation with the logical status of b91.2, 91.3 and 91.4 (ex.: by pico-PLC).

Note: in this mode, the firmware manages b40.2, b40.6, Pr8, Pr9, Pr10, Pr11, Pr12 and Pr55.

10.3.5 General information

This chapter describes the method by which a drive seeks the home position (also called, the datum, reference point or zero point). There are various methods of achieving this using limit switches at the ends of travel or a home switch (zero point switch) in mid-travel, most of the methods also use the index (zero) pulse train from an incremental encoder.

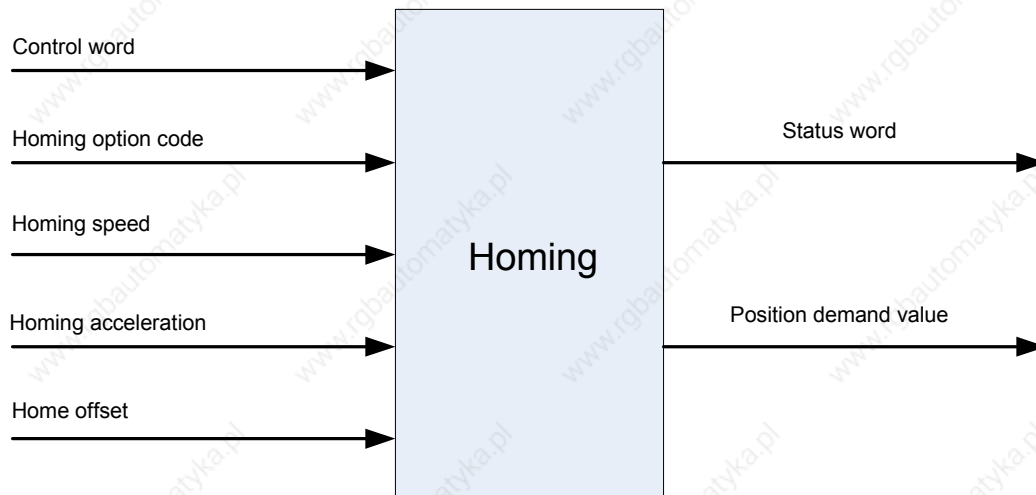

Figure 20: The homing function

10.3.5.1 Input data description

The user can specify the speeds, acceleration and the method of homing. There is a further object *home offset* which allows the user to displace zero in the user's coordinate system from the home position.

There are two *homing speeds*; in a typical cycle the faster speed is used to find the home switch and the slower speed is used to find the index pulse. The manufacturer is allowed some discretion in the use of these speeds as the response to the signals may be dependent upon the hardware used.

10.3.5.2 Output data description

There is no output data except for those bits in the *statusword* which return the status or result of the homing process and the demand to the position control loops.

10.3.5.3 Internal states

The homing mode will control by the bits of the *controlword* and *statusword*.

10.3.5.3.1 Controlword of homing mode

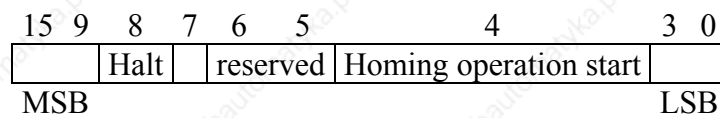

Name	Value	Description
Homing operation start	0	Homing mode inactive
	0 → 1	Start homing mode
	1	Homing mode active
	1 → 0	Interrupt homing mode
Halt	0	Execute the instruction of bit 4
	1	Stop axle with homing acceleration

Table 11: Homing mode bits of the *controlword*

10.3.5.3.2 Statusword of homing mode

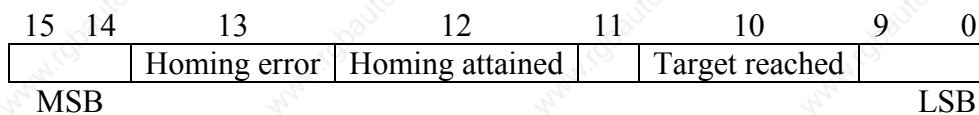

Name	Value	Description
Target reached	0	Halt = 0: Home position not reached Halt = 1: Axle decelerates
	1	Halt = 0: Home position reached Halt = 1: Axle has velocity 0
Homing attained	0	Homing mode not yet completed
	1	Homing mode carried out successfully
Homing error	0	No homing error
	1	Homing error occurred; Homing mode carried out not successfully; The error cause is found by reading the error code

Table 12: Homing mode bits of the *statusword*

10.3.6 Object dictionary entries

10.3.6.1 Objects defined in this chapter

Index	Object	Name	Type	Attr.	M/O
607Ch	VAR	<i>Home offset</i>	INTEGER32	rw	O
6098h	VAR	<i>Homing method</i>	INTEGER8	rw	M
6099h	ARRAY	<i>Homing speeds</i>	UNSIGNED32	rw	M
609Ah	VAR	<i>Homing acceleration</i>	UNSIGNED32	rw	O

10.3.6.2 Objects defined in other chapters

Index	Object	Name	Type	Chapter
6040h	VAR	<i>Controlword</i>	UNSIGNED16	dc
6041h	VAR	<i>Statusword</i>	UNSIGNED16	dc

10.3.7 Object description

10.3.7.1 Object 607Ch: *Home offset*

The *home offset* object is the difference between the zero position for the application and the machine home position (found during homing), it is measured in position units. During homing the machine home position is found and once the homing is completed the zero position is offset from the home position by adding the *home offset* to the home position. All subsequent absolute moves shall be taken relative to this new zero position. This is illustrated in the following diagram.

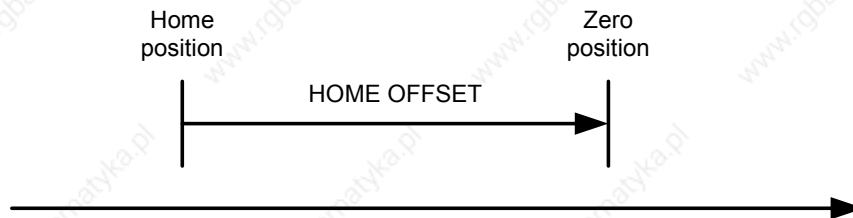

Figure 21: Home offset If the *home offset* is not implemented then it shall be zero.

OBJECT DESCRIPTION

INDEX	607Ch
Name	Home offset
Object Code	VAR
Data Type	INTEGER32
Category	Optional

ENTRY DESCRIPTION

Access	rw
PDO Mapping	Possible
Value Range	INTEGER32
Default Value	0

10.3.7.2 Object 6098_n: Homing method

The *homing method* object determines the method that will be used during homing. OBJECT DESCRIPTION

INDEX	6098 _n
Name	Homing method
Object Code	VAR
Data Type	INTEGER8
Category	Conditional;
	Mandatory, if hm supported

ENTRY DESCRIPTION

Access	rw
PDO Mapping	Possible
Value Range	INTEGER8
Default Value	0

DATA DESCRIPTION

Value	Description
-128 .. -1	manufacturer specific
0	No homing operation required
1..35	Methods 1 to 35 (see the functional description)
36 .. 127	reserved

10.3.7.3 Object 6099_n: Homing speeds

This entry in the object dictionary defines the speeds used during homing and is given velocity units. OBJECT DESCRIPTION.

INDEX	6099 _n
Name	Homing speeds
Object Code	ARRAY
Data Type	UNSIGNED32
Category	Mandatory, if hm supported

ENTRY DESCRIPTION

Sub-Index	0
Description	number of entries
Entry Category	Mandatory
Access	ro
PDO Mapping	No
Value Range	2
Default Value	2

Sub-Index	1
Description	Speed during search for switch
Entry Category	Mandatory
Access	rw
PDO Mapping	Possible
Value Range	UNSIGNED32
Default Value	0

Sub-Index	2
Description	Speed during search for zero
Entry Category	Mandatory
Access	rw
PDO Mapping	Possible
Value Range	UNSIGNED32
Default Value	0

10.3.7.4 Object 609Ah: Homing acceleration

The *homing acceleration* establishes the acceleration to be used for all accelerations and decelerations with the standard homing modes and is given in acceleration units.

OBJECT DESCRIPTION

INDEX	609Ah
Name	Homing acceleration
Object Code	VAR
Data Type	UNSIGNED32
Category	Optional

ENTRY DESCRIPTION

Access	rw
PDO Mapping	Possible
Value Range	UNSIGNED32
Default Value	No

10.3.8 Functional description

By choosing a method of homing by writing a value to *homing method* will clearly establish

- the homing signal (positive limit switch, negative limit switch, home switch)
- the direction of actuation and where appropriate
- the position of the index pulse(*).

The home position and the zero position are offset by the *home offset*, see the definition of *home offset* for how this offset is used.

Various homing positions are illustrated in the following diagrams. An encircled number indicates the code for selection of this homing position. The direction of movement is also indicated. Further homing methods may be defined by the manufacturer using the negative values of *homing method*.

There are four sources of homing signal available, these are the negative and positive limit switches, the home switch and the index pulse from an encoder.

In the diagrams of homing sequences shown below, the encoder count increases as the axle's position moves to the right, in other words the left is the minimum position and the right is the maximum position.

For the operation of positioning drives, an exact knowledge of the absolute position is normally required. Since for cost reasons, drives often do not have an absolute encoder, a homing operation is necessary. There are several, application-specific methods. The *homing method* is used for selection.

The exact sequence of the homing operation is clearly described by the method. In some circumstances, a device has several methods to choose from, using the *homing method*.

(*) with resolver feedback, it's necessary set the object 0x6098 with negative sign. In this case the homing function is stopped immediately after the home sensor, and the actual position becomes the home position.

10.3.8.1 Homing methods

The following sub-sections describe the details of how each of the homing modes shall function.

10.3.8.1.1 Method 1: Homing on the negative limit switch and index pulse

Using this method the initial direction of movement is leftward if the negative limit switch is inactive (here shown as low). The home position is at the first index pulse to the right of the position where the negative limit switch becomes inactive.

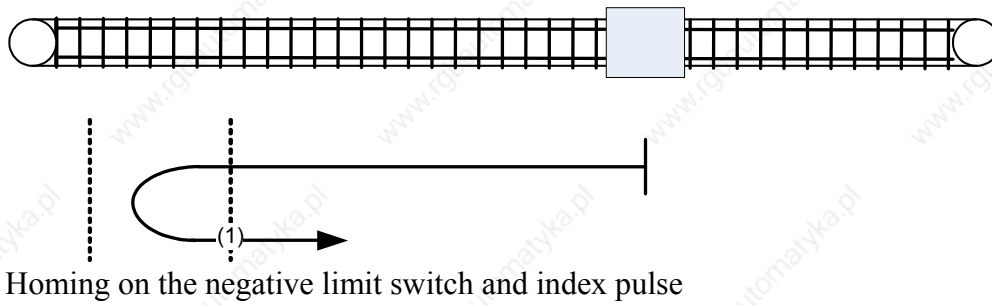

10.3.8.1.2 Method 2: Homing on the positive limit switch and index pulse

Using this method the initial direction of movement is rightward if the positive limit switch is inactive (here shown as low). The position of home is at the first index pulse to the left of the position where the positive limit switch becomes inactive.

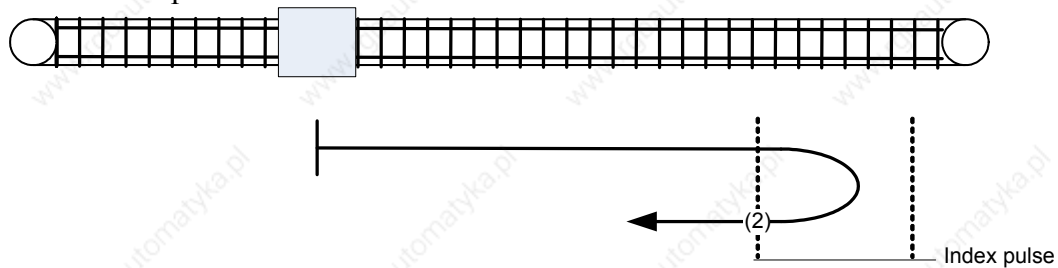

Figure 23: Homing on the positive limit switch and index pulse

10.3.8.1.3 Methods 3 and 4: Homing on the positive home switch and index pul.

Using methods 3 or 4 the initial direction of movement is dependent on the state of the home switch. The home position is at the index pulse to either to the left or the right of the point where the home switch changes state. If the initial position is sited so that the direction of movement must reverse during homing, the point at which the reversal takes place is anywhere after a change of state of the home switch.

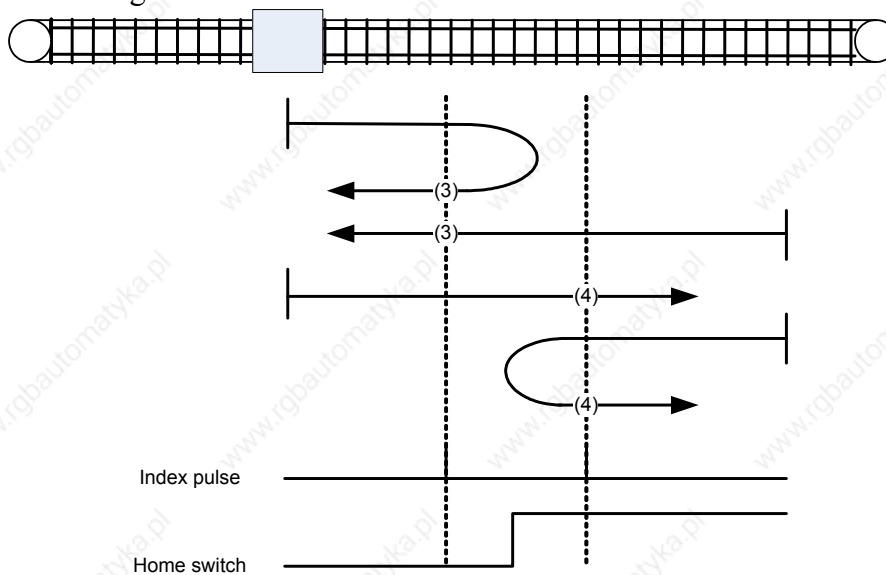

Figure 24: Homing on the positive home switch and index pulse

10.3.8.1.4 Methods 5 and 6: Homing on the negative home switch and index pul.

Using methods 5 or 6 the initial direction of movement is dependent on the state of the home switch. The home position is at the index pulse to either to the left or the right of the point where the home switch changes state. If the initial position is sited so that the direction of movement must reverse during homing, the point at which the reversal takes place is anywhere after a change of state of the home switch.

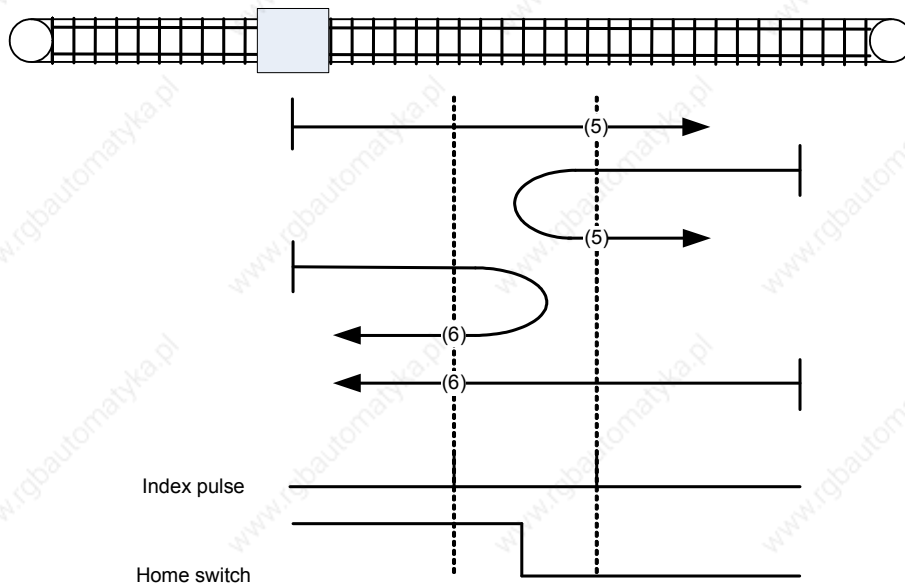

Figure 25: Homing on the negative home switch and index pulse

10.3.8.1.5 Methods 7 to 14: Homing on the home switch and index pulse

These methods use a home switch which is active over only portion of the travel, in effect the switch has a 'momentary' action as the axle's position sweeps past the switch.

Using methods 7 to 10 the initial direction of movement is to the right, and using methods 11 to 14 the initial direction of movement is to the left except if the home switch is active at the start of the motion. In this case the initial direction of motion is Dependent on the edge being sought. The home position is at the index pulse on either side of the rising or falling edges of the home switch, as shown in the following two diagrams. If the initial direction of movement leads away from the home switch, the drive must reverse on encountering the relevant limit switch.

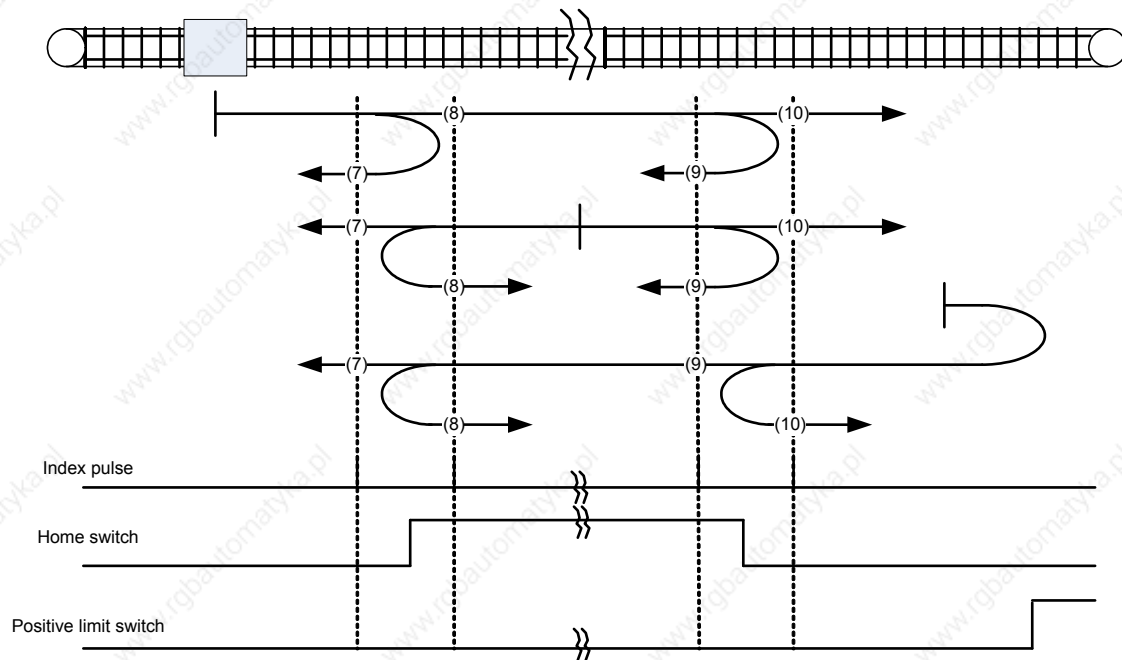

Figure 26: Homing on the home switch and index pulse - positive initial move

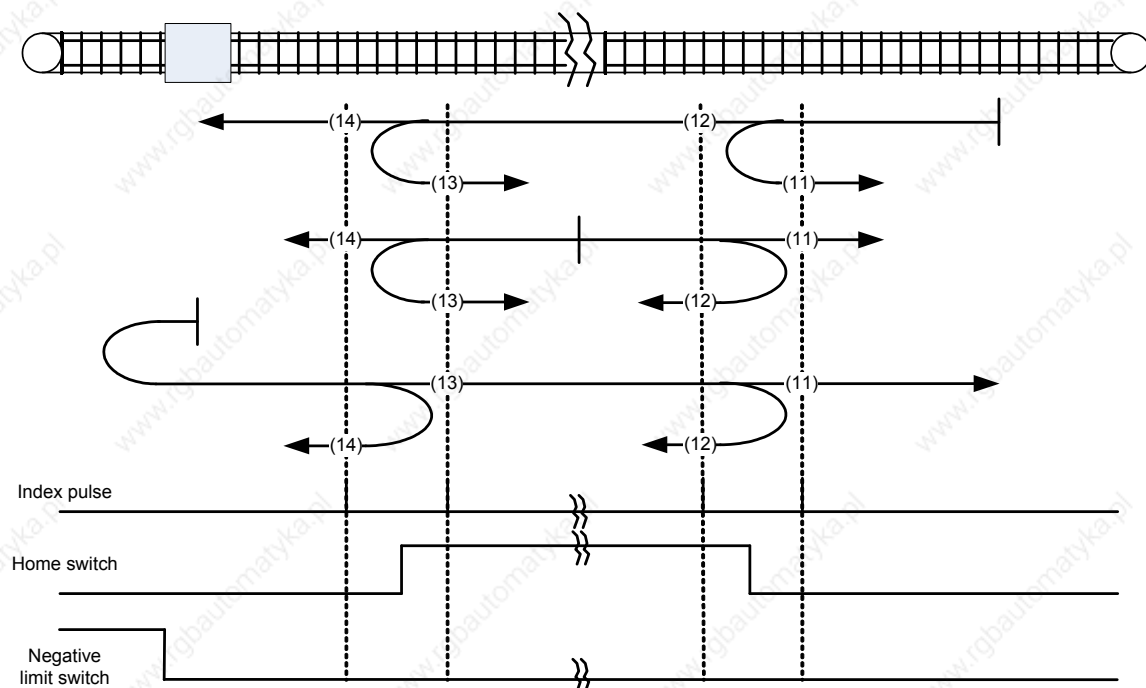

Figure 27: Homing on the home switch and index pulse - negative initial move

10.3.8.1.6 Methods 15 and 16: Reserved

These methods are reserved for future expansion of the homing mode.

10.3.8.1.7 Methods 17 to 30: Homing without an index pulse

These methods are similar to methods 1 to 14 except that the home position is not dependent on the index pulse but only dependent on the relevant home or limit switch transitions. For example methods 19 and 20 are similar to methods 3 and 4 as shown in the following diagram.

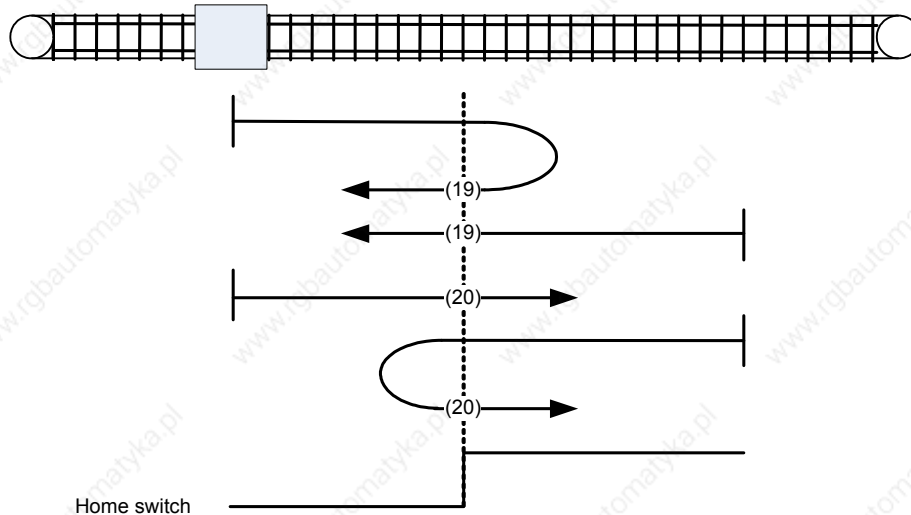

Figure 28: Homing on the positive home switch

10.3.8.1.8 Methods 31 and 32: Reserved

These methods are reserved for future expansion of the homing mode.

10.3.8.1.9 Methods 33 to 34: Homing on the index pulse

Using methods 33 or 34 the direction of homing is negative or positive respectively. The home position is at the index pulse found in the selected direction.

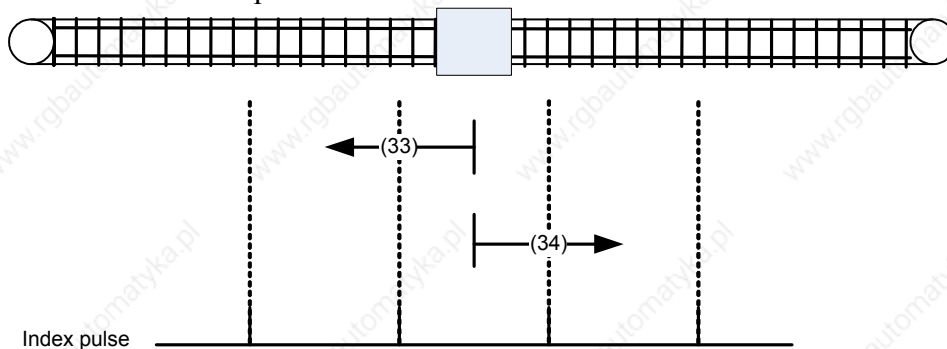

Figure 29: Homing on the index pulse

10.3.8.1.10 Method 35: Homing on the current position

In method 35 the current position is taken to be the home position.

10.3.9 Profile position mode (operative mode 201)

In profile position mode (Pr31=201) the buffer of targets allowed is 2 elements long one for the profile in execution the other for the next, the motion profile type only valid value is 0 (trapezoidal profile with linear ramp).

10.3.9.1 Internal states

The profile position mode will control by the bits of the controlword and statusword.

Index	Object	Name	Type	Attr.	M/O
607Ah	VAR	<i>Target position</i>	INTEGER32	rw	M
6081h	VAR	<i>Profile velocity</i>	UNSIGNED32	rw	M
6083h	VAR	<i>Profile acc./dec.</i>	UNSIGNED32	rw	M
6085h	VAR	<i>Quick stop deceleration</i>	UNSIGNED32	rw	O
6086h	VAR	<i>Motion profile type</i>	INTEGER16	rw	M

10.3.9.1.1 Controlword of profile position mode

15	9	8	7	6	5	4	3	0
	Halt		abs / rel	Change set immediately	New set-point			
MSB					LSB			

Name	Value	Description
New set-point	0	Does not assume <i>target position</i>
	1	Assume <i>target position</i>
Change set immediately	0	Finish the actual positioning and then start the next positioning
	1	Interrupt the actual positioning and start the next positioning
abs / rel	0	<i>Target position</i> is an absolute value
	1	<i>Target position</i> is a relative value
Halt	0	Execute positioning
	1	Stop axle with <i>profile deceleration</i> (if not supported with <i>profile acceleration</i>)

Table 9: Profile position mode bits of the *controlword*

10.3.9.1.2 Statusword of profile position mode

15	14	13	12	11	10	9	0
	Following error	Set-point acknowledge		Target reached			
MSB					LSB		

Name	Value	Description
Target reached	0	Halt = 0: <i>Target position</i> not reached Halt = 1: Axle decelerates
	1	Halt = 0: <i>Target position</i> reached Halt = 1: Velocity of axle is 0
Set-point acknowledge	0	Trajectory generator has not assumed the positioning values (yet)
	1	Trajectory generator has assumed the positioning values
Following error	0	No following error
	1	Following error

Table 10: Profile position mode bits of the *statusword*

10.3.9.2 Object dictionary entries

10.3.9.2.1 Objects defined in this chapter

Index	Object	Name	Type	Attr.	M/O
607A	VAR	<i>Target position</i>	INTEGER32	rw	M

Index	Object	Name	Type	Attr.	M/O
6081	VAR	<i>Profile velocity</i>	UNSIGNED32	rw	M
6083	VAR	<i>Profile acceleration / deceleration</i>	UNSIGNED32	rw	M
6085	VAR	<i>Quick stop deceleration</i>	UNSIGNED32	rw	O
6086	VAR	<i>Motion profile type</i>	INTEGER16	rw	M

Index	Object	Name	Type	Chapter
6040	VAR	<i>Controlword</i>	UNSIGNED16	dc
6041	VAR	<i>Statusword</i>	UNSIGNED16	dc
605A	VAR	<i>Quick stop option code</i>	INTEGER16	dc
6093 [1,2]	ARRAY	<i>Position factor</i>	UNSIGNED32	fg
6094 [1,2]	ARRAY	<i>Velocity encoder factor</i>	UNSIGNED32	fg
6097 [1,2]	ARRAY	<i>Acceleration factor</i>	UNSIGNED32	fg

10.3.9.2.2 Object 607A_n: *Target position*

The *target position* is the position that the drive should move to in position profile mode using the current settings of motion control parameters such as velocity, acceleration/deceleration, *motion profile type* etc. The *target position* is given in user defined position units. It is converted to position increments using the *position factor*. The *target position* will be interpreted as absolute or relative depending on the 'abs / rel' flag in the *controlword*.

OBJECT DESCRIPTION

INDEX	607Ah
Name	Target position
Object Code	VAR
Data Type	INTEGER32
Category	Conditional;
	Mandatory, if pp or pc supported

ENTRY DESCRIPTION

Access	rw
PDO Mapping	Possible
Value Range	INTEGER32
Default Value	No

10.3.9.2.3 Object 6081_h: Profile velocity

The *profile velocity* is the velocity normally attained at the end of the acceleration ramp during a profiled move and is valid for both directions of motion. The *profile velocity* is given in user defined speed units. It is converted to position increments per second using the *velocity encoder factor*.

OBJECT DESCRIPTION ENTRY DESCRIPTION

INDEX	6081h
Name	Profile velocity
Object Code	VAR
Data Type	UNSIGNED32
Category	Conditional;
	Mandatory, if pp or pv supported

Access	rw
PDO Mapping	Possible
Value Range	UNSIGNED32
Default Value	No

10.3.9.2.4 Object 6083_h: Profile acceleration/deceleration

The *profile acceleration/deceleration* is given in user defined acceleration units. It is converted to position increments per second² using the normalizing factors.

OBJECT DESCRIPTION

INDEX	6083h
Name	Profile acceleration/deceleration
Object Code	VAR
Data Type	UNSIGNED32
Category	Conditional;
	Mandatory, if pp or pv supported

ENTRY DESCRIPTION

Access	rw
PDO Mapping	Possible
Value Range	UNSIGNED32
Default Value	No

10.3.9.2.5 Object 6085_n: Quick stop deceleration

The *quick stop deceleration* is the deceleration used to stop the motor if the 'Quick Stop' command is given and the *quick stop option code* (see 605Ah) is set to 2. The *quick stop deceleration* is given in the same units as the *profile acceleration*.

OBJECT DESCRIPTION

INDEX	6085h
Name	Quick stop deceleration
Object Code	VAR
Data Type	UNSIGNED32
Category	Optional

ENTRY DESCRIPTION

Access	rw
PDO Mapping	Possible
Value Range	UNSIGNED32
Default Value	No

10.3.9.2.6 Object 6086_n: Motion profile type

The *motion profile type* is used to select the type of motion profile used to perform a profiled move.

Value	Description
0	Linear ramp (trapezoidal profile)

OBJECT DESCRIPTION

INDEX	6086h
Name	Motion profile type
Object Code	VAR
Data Type	INTEGER16
Category	Conditional;
	Mandatory, if pp or pv supported

ENTRY DESCRIPTION

Access	rw
PDO Mapping	Possible
Value Range	INTEGER16
Default Value	0

10.3.9.3 Functional description

Two different ways to apply *target positions* to a drive, are supported by this device profile. Set of set-points: After reaching the *target position* the drive unit immediately processes the next *target position* which results in a move where the velocity of the drive normally is not reduced to zero after achieving a set-point.

Single set-point: After reaching the *target position* the drive unit signals this status to a host computer and then receives a new set-point. After reaching a *target position* the velocity normally is reduced to zero before starting a move to the next set-point.

The two modes are controlled by the timing of the bits 'new set-point' and 'change set immediately' in the *controlword* and 'set-point acknowledge' in the *statusword*. These bits allow to set up a request-response mechanism in order to prepare a set of set-points while another set still is processed in the drive unit. This minimizes reaction times within a control program on a host computer.

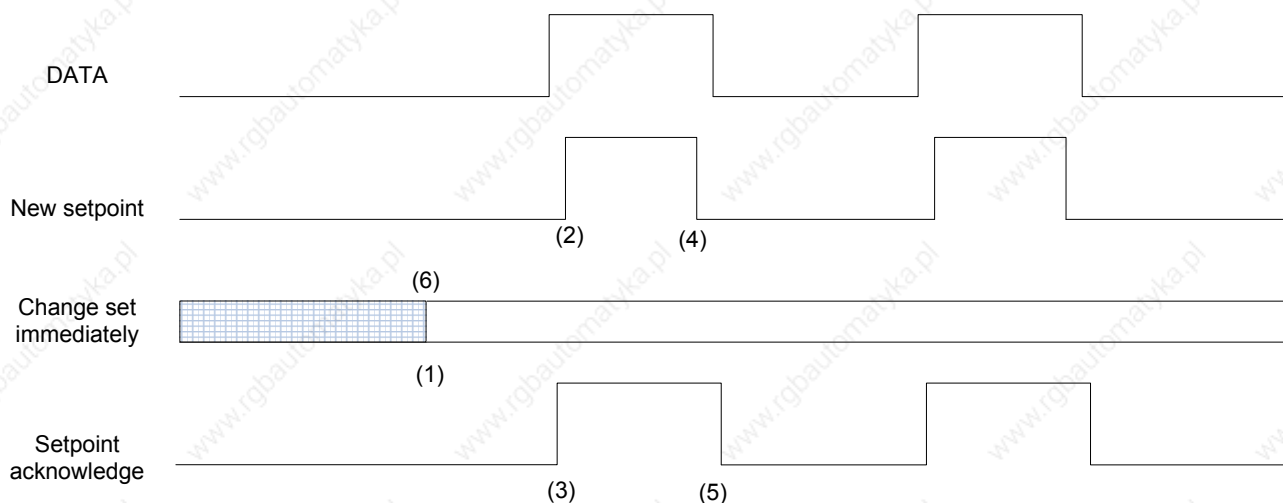

Figure 17: Set-point transmission from a host computer

Figure 17, Figure 18 and Figure 19 show the difference between the "set of set-points" mode and the "single set-point" mode. The initial status of the bit 'change set immediately' in the *controlword* determines which mode is used. To keep simple these examples, only trapezoidal moves are used.

If the bit 'change set immediately' is "0" (continuously drawn line in Figure 17) a single set-point is expected by the drive (1). After data is applied to the drive, a host signals that the data is valid by changing the bit 'new set-point' to "1" in the *controlword* (2). The drive responds with 'set-point acknowledge' set to "1" in the *statusword* (3) after it recognized and buffered the new valid data. Now the host may release 'new set-point' (4) and afterwards the drive signals with 'set-point acknowledge' equal "0" its ability to accept new data again (5). In Figure 18 this mechanism results in a velocity of zero after ramping down in order to reach a *target position* x_1 at t_1 . After signaling to the host, that the set-point is reached like described above, the next *target position* x_2 is processed at t_2 and reached at t_3 .

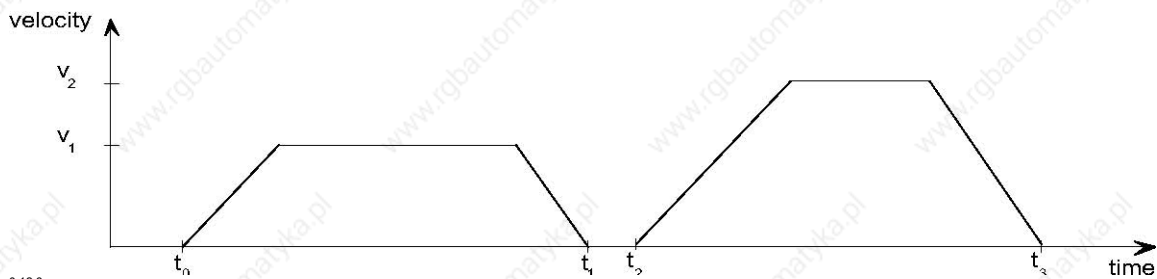

Figure 18: Single set-point

If the bit 'change set immediately' is "1" (dashed line in Figure 17) the new target position will be active immediately. In Figure 19 the drive receives the first *target position* at t_0 . At the time point t_1 the drive receives a second *target position*. The drive readapts the actual move to the new target position immediately.

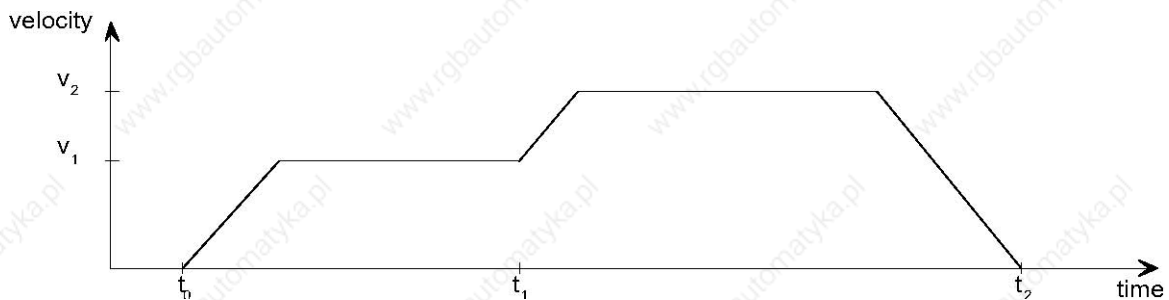
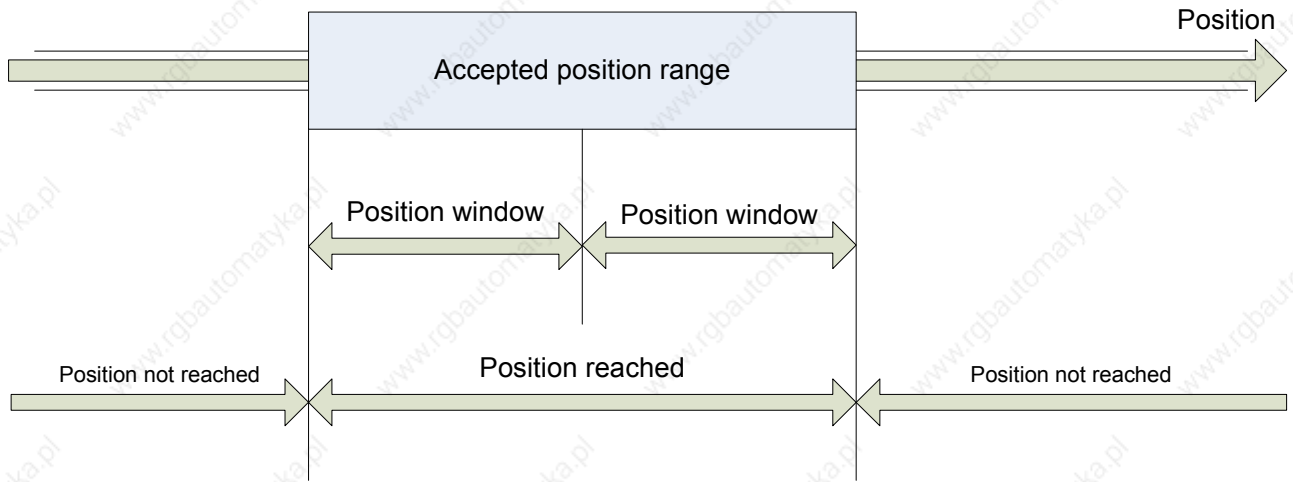

Figure 19: Change set immediately

10.3.9.4 Functional description

Figure 33 shows the meaning of the sub-function position reached. Symmetrically around the *target position* a window is defined for the accepted position range. If a drive is situated in the accepted position range over the time *position window time* the bit *target reached* (bit 10) in the *statusword* is to set.



target position Figure 33: Position reached

Figure 34 shows the meaning of the sub-function *following error* in the profile position mode. Symmetrically around the reference position a window is defined for the accepted following error tolerance. If a drive is situated out of the accepted position range for more than *following error time out* time the bit *following error* (bit 13) in the *statusword* is set. Accepted following

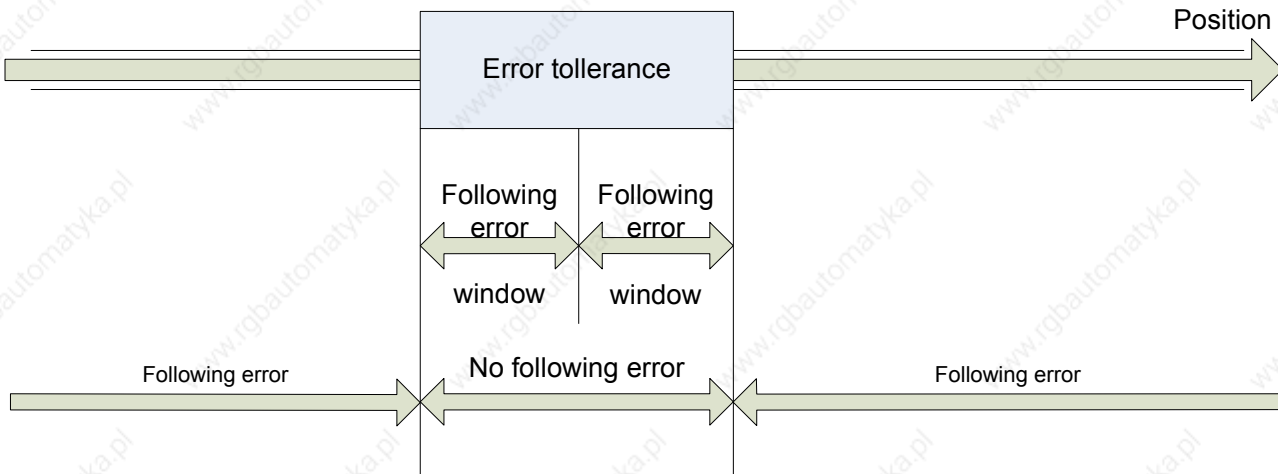

reference position Figure 34: Following error

The following error window is used to signal by mean of status word the servo error condition on user defined BIT14 when Interpolated position mode is active and with standard bit 13 in profile position mode. This feature isn't valid for rel 206 yet.

If the user sets b272.3 a fault reaction sequence is entered and according to the fault reaction option code(valid values 0,1,2) the motor is stopped and finally disabled sending an emergency message with error code 0xff11 and user data loaded with pr[108:109].This feature isn't valid for rel 206 yet.

10.3.10 Interpolated Position Mode (operative mode 202)

In Interpolated Position Mode (Pr31=202) the cycle time is set in the object 0x1006 'communication cycle period' and depending on the value set in this object different ways of regulation are possible.

If the value is less than 2500 μ sec the position loop is executed at the moment the sync signal is received the position reference received on the PDO is directly processed as target of the position loop. If the value is more or equal than 2500 μ sec the position reference received is interpolated according the interpolation sub mode index 0x60c0, the interpolation may be cubic or linear.

If object 0x60c0 is 0 the interpolation algorithm is linear otherwise if -1 is cubic with both position and velocity reference, if -2 is cubic with position reference only.

If on the synchronous PDO 4 rx it is not mapped the position reference the position loop is not executed but the velocity reference received is set, the velocity reference may be supplied in counts/sec or RPM respectively mapping object 0x60c1.2 or 0x60c1.3, in this case the external controller executes position loop.

Note: In interpolated position mode factor group conversion are not active. If the cycle time is less than 2500 μ sec the feedforward of velocity may be computed by the drive (if bit 247.7 is set) from the delta of position reference in the cycle time (gain of feedforward component should be set accordingly with the cycle time). Otherwise feedforward of velocity may be sent with PDO4 rx mapping in RPM units the object 0x60c1.3.

Depending on the different algorithms of interpolation there is a different delay between the moment the target position is received on the PDO and validated by the sync and the moment when the target position is active in the trajectory setpoint of the motor.

In case of cycle time less than 2500 μ sec the position loop trajectory setpoint is immediately upgraded with the last received position setpoint as soon as the sync signal is received.

In case of cycle time longer than 2500 μ sec, both with linear interpolation and cubic interpolation with position and velocity, the point specified in the target position received on the PDO will be activated as trajectory setpoint at the end of the cycle time started with the sync signal that validated the target position, so with a cycle time delay.

As last, in case of cycle time longer than 2500 μ sec and cubic interpolation with position reference only, the point specified in the target position received on the PDO will be activated as trajectory setpoint at the end of the next cycle time started with the sync signal that validated the target position, so with two cycle time delay.

Index	Object	Name	Type	Attr.	M/O
60C0h	VAR	Interpolation sub mode select	INTEGER16	rw	O
60C1h	ARRAY	Interpolation data record	INTEGER32	rw	O

Index	Object	Name	Type	Chapter
6040h	VAR	Controlword	UNSIGNED16	dc
6041h	VAR	Statusword	UNSIGNED16	dc
605Ah	VAR	Quick stop option mode	INTEGER16	dc
6060h	VAR	Modes of operation	INTEGER8	dc
6061h	VAR	Modes of operation display	INTEGER8	dc
6063h	VAR	Position actual value*	INTEGER32	pc

10.3.10.1 Object 60C0h: Interpolation sub mode select

For the interpolated position mode a manufacturer may offer different interpolation algorithms. This object reflects or changes the actually chosen interpolation mode.

OBJECT DESCRIPTION

INDEX	60C0h
Name	Interpolation sub mode select
Object Code	VAR
Data Type	INTEGER16
Category	Optional

ENTRY DESCRIPTION

Access	rw
PDO Mapping	Possible
Value Range	0..-2
Default Value	0

DATA DESCRIPTION

Value	Description
-2	Cubic interpolation only position
-1	Cubic interpolation speed+position
0	Linear interpolation
+1..+32767	reserved

10.3.10.2 Object 60C1h: Interpolation data record

The *interpolation data record* are the data words which are necessary to perform the interpolation algorithm. The number N of data words in the record is defined by *interpolation data configuration*. The interpretation of the data words in *interpolation data record* may vary with the different possible interpolation modes as set by the *interpolation sub mode select*.

For the linear interpolation mode each interpolation data record simply can be regarded as a new position set-point. To describe a cubic spline interpolation e.g., four or more data words are needed for the spline coefficients, and further interpolation parameters.

After the last item of an *interpolation data record* is written to the devices input buffer, the pointer of the buffer is automatically incremented to the next buffer position.

OBJECT DESCRIPTION

INDEX	60C1h
Name	Interpolation data record
Object Code	ARRAY
Data Type	INTEGER32
Category	Optional

ENTRY DESCRIPTION

Sub-Index	0
Description	number of entries 3
Entry Category	Mandatory
Access	ro
PDO Mapping	No
Value Range	3
Default Value	No

Sub-Index	1
Description	Position setpoint in counts the first parameter of ip function fip(x1, .. xN)
Entry Category	Mandatory
Access	rw
PDO Mapping	Possible
Value Range	INTEGER32
Default Value	No

Sub-Index	2
Description	Velocity setpoint in counts/sec the second parameter of ip function fip(x1, .. xN)
Entry Category	Optional
Access	rw
PDO Mapping	Possible
Value Range	INTEGER32
Default Value	No

Sub-Index	3
Description	Velocity setpoint in rpm the 3-rd parameter of ip function fip(x1, .. xN)
Entry Category	Optional
Access	rw
PDO Mapping	Possible
Value Range	INTEGER32
Default Value	No

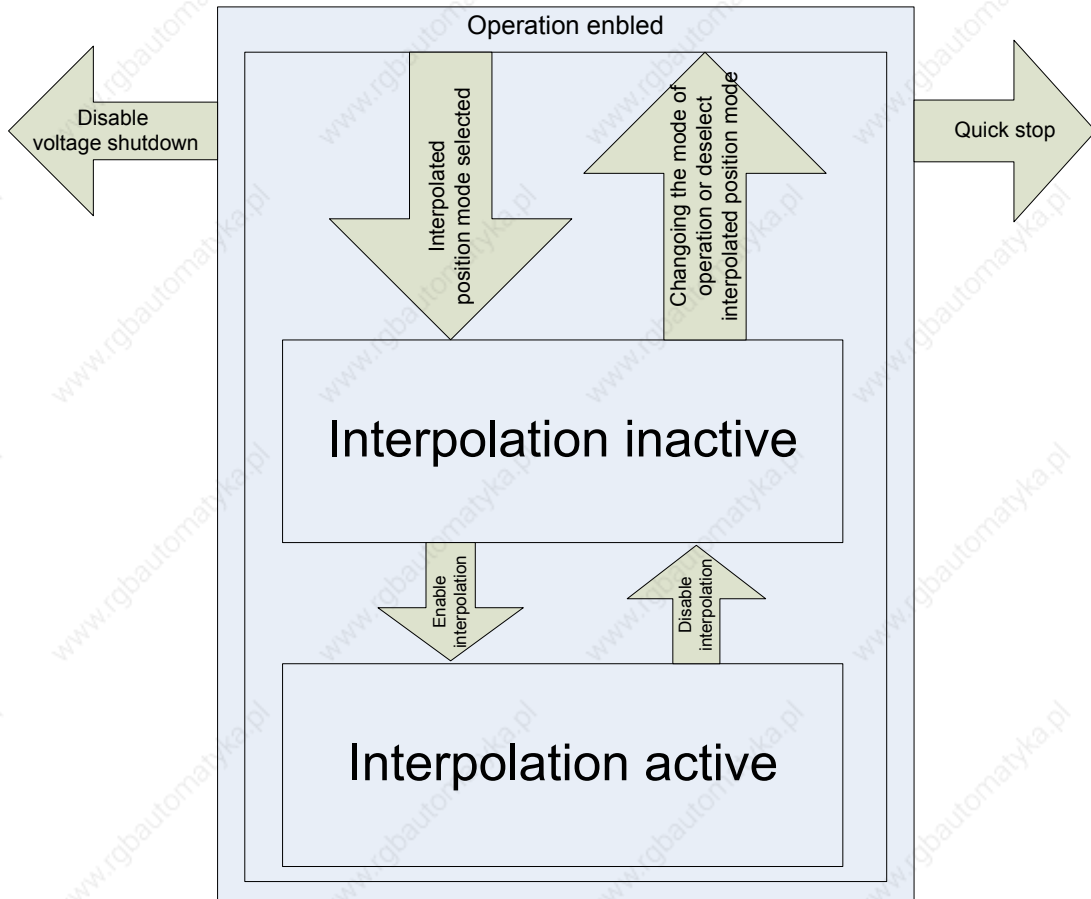

10.3.11 Drive parameters

Some debug commands and parameters are added concerning CANopen

Par.	Description	Field	Range	Def.	Ris.
Pr273	CANOPEN_CTRL_WORD. Control of drive status.	R	-32768÷ +32767	0	1
Pr274	CANOPEN_STATUS_WORD. Status of the drive.	R	-32768÷ +32767	0	1
Pr275	CANOPEN_DS301_STATUS. Status of communication profile DS301.	R	-32768÷ +32767	0	1

Par.	Description	Field	Def.
b271.8	Enable sync check. (1) enables missing sync check dsp 402 CANopen	R/W	0
b272.1	Conversion of velocity. (1) conversion in internal units of velocity [rpm*256] and acceleration [count/(sec ² *520)]. (0) conversion of velocity and acceleration in rpm e msec/krpm	R/W	0
b272.3	Fault reaction sequence. (1) a fault reaction sequence is entered and according to the fault reaction option code(valid values 0,1,2) the motor is stopped and finally disabled sending an emergency message.	R/W	0
b272.9	Remote mode. (1) Remote mode CANopen (0) remote disabled	R/W	0

Note: When in remote mode the bit b40.6, b40.2 and the parameters Pr8, Pr9, Pr10, Pr11, Pr12 and Pr55 are handled by firmware according to CANopen network setting and commands and should not be modified by the user.



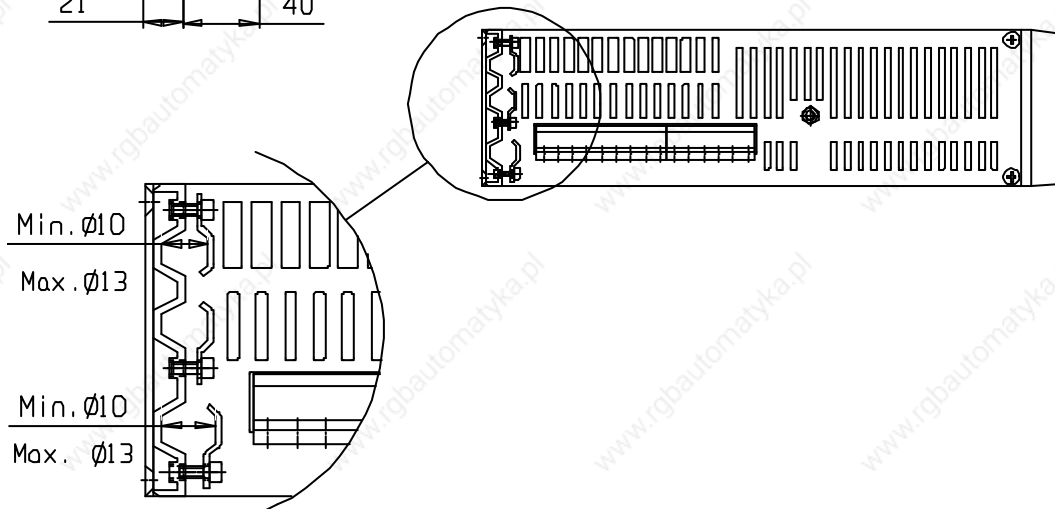
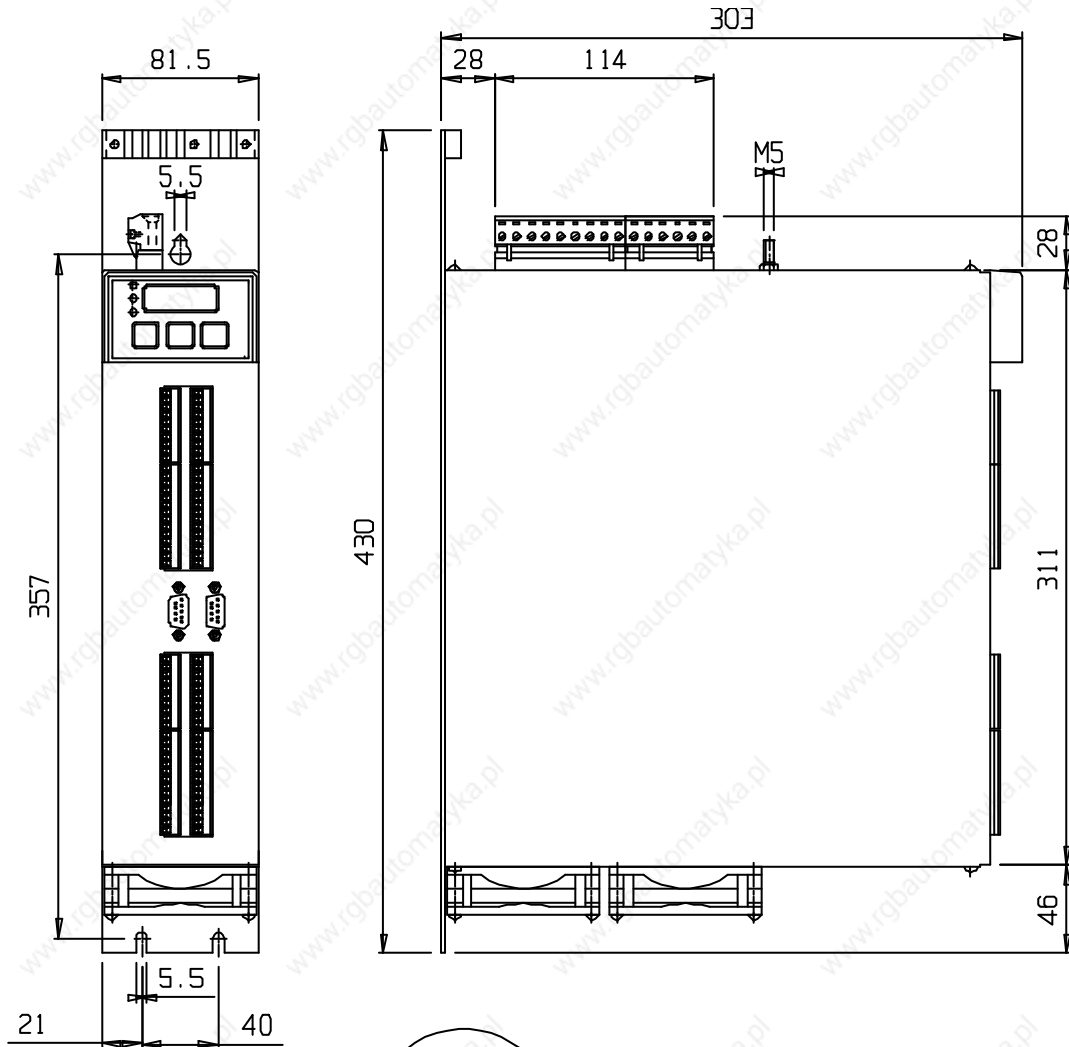

Note: When in *interpolated position mode* Feed-forward of speed enable in case of sync frequency is >400Hz, set b247.7=1, b70.6=0 and b70.7=0. Otherwise when the frequency is <400Hz, set b247.7=0, b70.6=0 and b70.7=0.

11 Appendix A: Mechanical dimensions

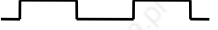

weight: 6,5kg

12 Appendix B: Conventions

Reference	Positive
Motor shaft movement (motor shaft view)	
Torque	Positive
Resolver counter	Increments
Encoder output	A  B 
Tachometer signal	Positive
I_u	$couple \cdot \sin(\vartheta)$
I_v	$couple \cdot \sin\left(\vartheta + \frac{2 \cdot \pi}{3}\right)$
Positive auxiliary input	Pr22 positive
Encoder In. A  B 	Increment counter

13 Appendix C: Software timing

Period	Task
64 μ s	Current control
128 μ s	Speed control
	Torque limits control
	Speed reference management
512 μ s	Braking resistor management
	FIN management
6.144 ms	Thermal motor image
	Digital inputs
	Program scanning pico-PLC
	Digital outputs
49.152 ms	Speed window management

14 Appendix D: default program for pico-PLC

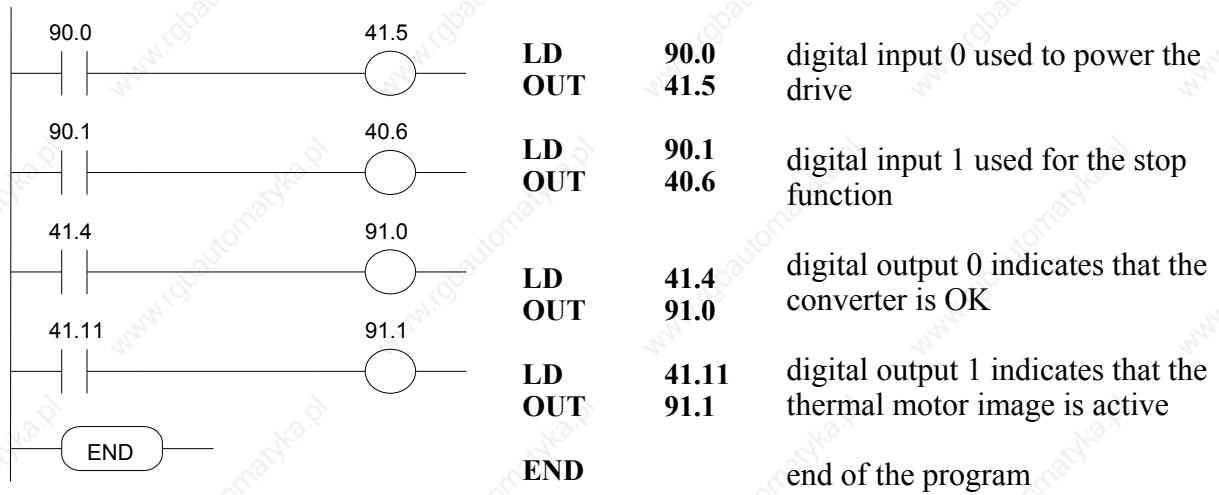

15 Appendix E: Flash information

- TO SAVE USA IL b99.15 PARAMETERS
- TO SAVE THE PLC USA IL b99.14 PROGRAM
- TO CHANGE THE INSTRUCTIONS, PLC b99.13 MUST BE 0
- WHEN THE OPERATING MODE IS CHANGED, YOU MUST USE b99.11 TO LOAD THE DEFAULT PARAMETERS (b40.2 MUST BE 0)
- BEFORE CHANGING Pr31, BE SURE THAT b40.2=0
- THE SPEED REFERENCE WILL BE LIMITED TO THE VALUE OF Pr32
- USING THE TORQUE CONTROL, Pr2 AND Pr3 MUST BE SET TO 1000
- TO USE THE ACTIVE OPERATING MODE, b40.2 MUST BE 1
- IF YOU CANNOT MODIFY THE READ-WRITE PARAMETERS USING THE KEYPAD, BE SURE THAT E b99.7 IS 0. IF IT WAS 0, PROBABLY THE SAME PARAMETERS WERE MODIFIED BY THE PLC PROGRAM.

16 Appendix F: Alarms

Malfunction error code (Pr23)	Alarm	Remedies
0	No alarm	
1	DC circuit overvoltage	Check the three-phase power line (max 480V + 10%). Check the break circuit and the braking resistor
2	DC circuit undervoltage	Check the three-phase power line.
3	Overcurrent	Check the motor connections and any phase-phase or phase-ground short-circuits. Check the motor data.
4	FBK error (resolver or encoder)	Check the connections of the speed loop and the connectors on both sides (drive-motor). Check the feedback parameters.
5	PTC motor alarm	Check the PTC connection cable. Check the parameters Pr33 (I_{nom}) and Pr19 (I_{peak}).
6	Power module overtemperature	Check the cooling fans and for any restrictions to air flow. Check the braking cycle. Check the ambient temperature in the electric cabinet where the drive is installed, as well as the ambient temperature outside the cabinet.
7	External alarm	Depends on the application (b41.7 – see Pico-PLC program)
8	Auxiliary alarm	Depends on the application (b41.8 – see Pico-PLC program)
10 (*)	PLC check sum	Set and save default parameters, switch off and on again the drive and repeat programming.
11 (*)	Parameter check sum	Set and save default parameters, switch off and on again the drive and repeat programming.
14	Overload braking resistor	Check the braking cycle.
15	Default parameters	Set and save default parameters, switch off and on again the drive and repeat programming.
17 (**)	Hardware broken	Internal damage, to send to repair.
22	Ambient over temperature	The ambient temperature in the electric cabinet is excessive (>45°C). Check the cooling fans and for any restrictions to air flow.

Malfunction error code (Pr23)	Alarm	Remedies
24	Braking dynamic protection	Short-circuit braking resistance. If an external braking resistor is connected to the drive, check the resistor status and wiring.
25 (**)	Speed loop FBK initialization error	Check the speed FBK settings. Check the speed FBK connection.
30	EEPROM not recognized	Internal damage, to send to repair.
TripP.x "x" is a number	Hardware broken	Internal damage, to send to repair.
I ² T "The display shows decimal points on all characters"	Current limit (I ² T)	The drive goes in I ² T mode due to an overload (the current required is more than the current that can be supplied). Check : The wiring between drive and motor (there should be no inverted phases). Take special care with motors where the connector is replaced by a terminal block : it's easy to make a mistake. Adhere strictly to the wiring diagrams. Mechanical dimensioning

(*) reset only after default values have been loaded and saved.

(**) can be only reset at the next power on.

17 Appendix G: option “R” for safe disable function

17.1 Introduction

The drive ordered with “R” option are manufactured and validated to implement category 3 safety disable as described in EN 954-1 and EN 13849-1

By mean of this function it is possible to guarantee that unwanted restart of the motor movements will not be allowed, even without using electromechanical switches between drive and motor.

Drives labelled with “R” options are equipped of a electromechanical safety relay (certified by TÜV institute). This relay, driven by user, turns off safely power semiconductor stage and gives back a feedback though a free potential switch (normally closed).

The safe disable turns off the output power through an electromechanical action, independent from drive firmware.

In TWIN-N drives both axes output power stages are switched off using a unique signal.



WARNING

The safe disable function prevent from torque generation in an squirrel cage induction motor connected to the drive even if a drive fault does occur.

If a permanent magnet synchronous motor (brushless) is connected, a short rotation may occurs: 180° maximum, that becomes 90° maximum in case of salient poles technology motors.

Machines risk assessment activity must take care of this fact.



WARNING

The safe disable function do not provide an electrical shock prevention, so in case of service activity on electrical connections, electrical power must be disconnected from drive and operator must wait for the complete discharge of all internal capacitors (almost 6 minutes).



WARNING

The safe disable function inhibit the power stage of the drive including dynamic brake power stage: for this reason when the safe disable signal is activated a fast emergency stop will not be allowed.



WARNING

The safe disable function guarantees machine safety only if it is correctly applied in the whole machine safety plant.

The machine have to be verified through a risk assessment activity to be sure that the residual risk of a dangerous event is compatible with risk class of the machine itself.

Safety related systems and plants have to be designed by people skilled and trained as required.



WARNING

The category 3 safety standstill function in compliance with EN954-1 and EN13849-1 standards, is only guaranteed if all the feedback signals available from the drive (both hardware SC-A/SC-B and software b90.6) are included in the machine / application safety system, accordingly to the following instructions.

17.2 Signals description

On front side terminal box labelled with II following signals are connected:

- safety relay activation command on terminals 24 and 48 (labelled SR+ and SR-)
- safety relay feedback switch contacts on terminals 22 and 23 (labelled SC-A and SC-B)

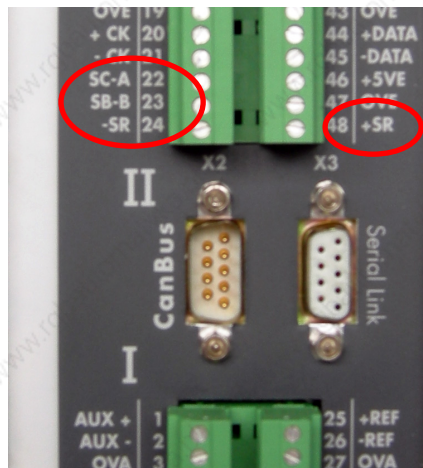

Terminal box II pin	Signal	Description	Current consumption	DC Voltage level
24-48	-SR / +SR	Safe disable command	33mA \pm 10% (@ 24Vdc)	24Vdc \pm 10% (relay on) < 1V (relay off)
22-23	SC-A / SC-B	Feedback NC potential free switch	max 1A	24Vdc \pm 10%

-SR/+SR input is protected against wrong polarity connections.

When +24VDC voltage is applied to terminal +SR with respect to terminal SR-, switching ON the safety relay, power supply to output power stage of the drive is present, so the motor movements are not safely stopped. Under this condition the safety relay feedback switch,

whose contacts, are connected to terminals SC-A and SC-B and mechanically driven by relay mechanics, is open.

This represent the working condition for drive and motor.

When power supply is disconnected from +SR and SR- terminals, switching OFF safety relay, one of the relay switch cuts OFF power to drive output power stage driving circuits, disabling output power stage. Under this condition the safety relay feedback switch, whose contacts, are connected to terminals SC-A and SC-B and mechanically driven by relay mechanics, is closed.

A dedicated drive parameter (b90.6) shows the safety relay status of each of the two power output stages (drives) let it to be an available information addressable over fieldbus communication or standard digital outputs of the converter.

Using this kind of information will increase redundancy level of the safety chain, decreasing the risk of human and equipment injury.

Attention: both feedback have to be connected within the safety chain of the machine.

This issue must be considered: while switch feedback connected to terminals SC-A and SC-B is a free potential switch driver directly by safety relay, so its work is independent from drive firmware; parameter feedback, otherwise, is implemented and used through drive firmware functions.

The description above is summarized in following table:

safety relay command -SR / +SR	Safety relay feedback switch status SC-A / SC-B	Safety relay firmware feedback status b90.6	Safety condition against unwanted motor restarts
24V (relay ON)	open	1	No
0V (relay OFF)	closed	0	Yes

17.3 Drive function blocks

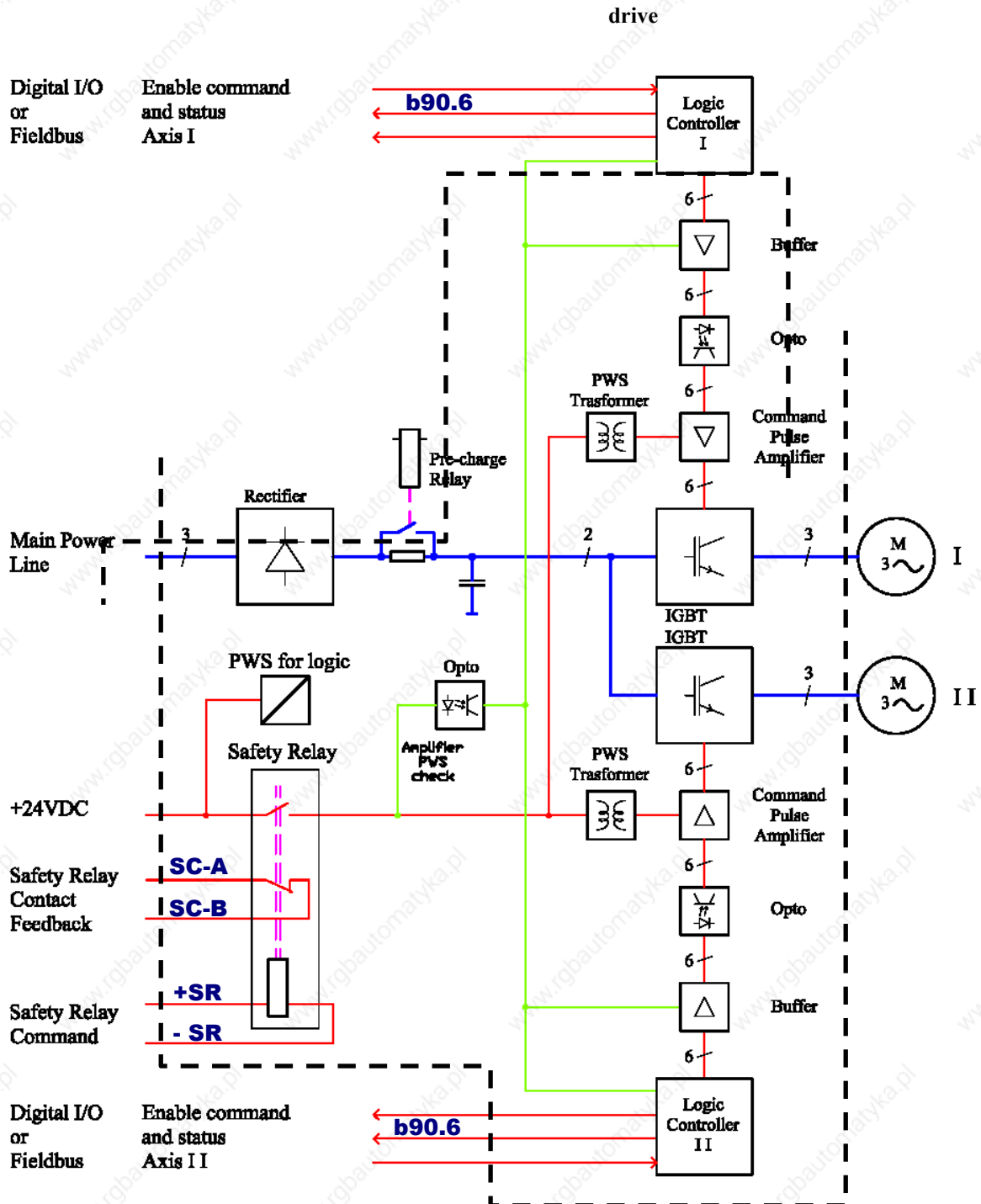

17.4 Connections

The following diagrams show how to use the safe disable function. They should be considered as a generic reference example. Any specific machine/application design must be analysed.

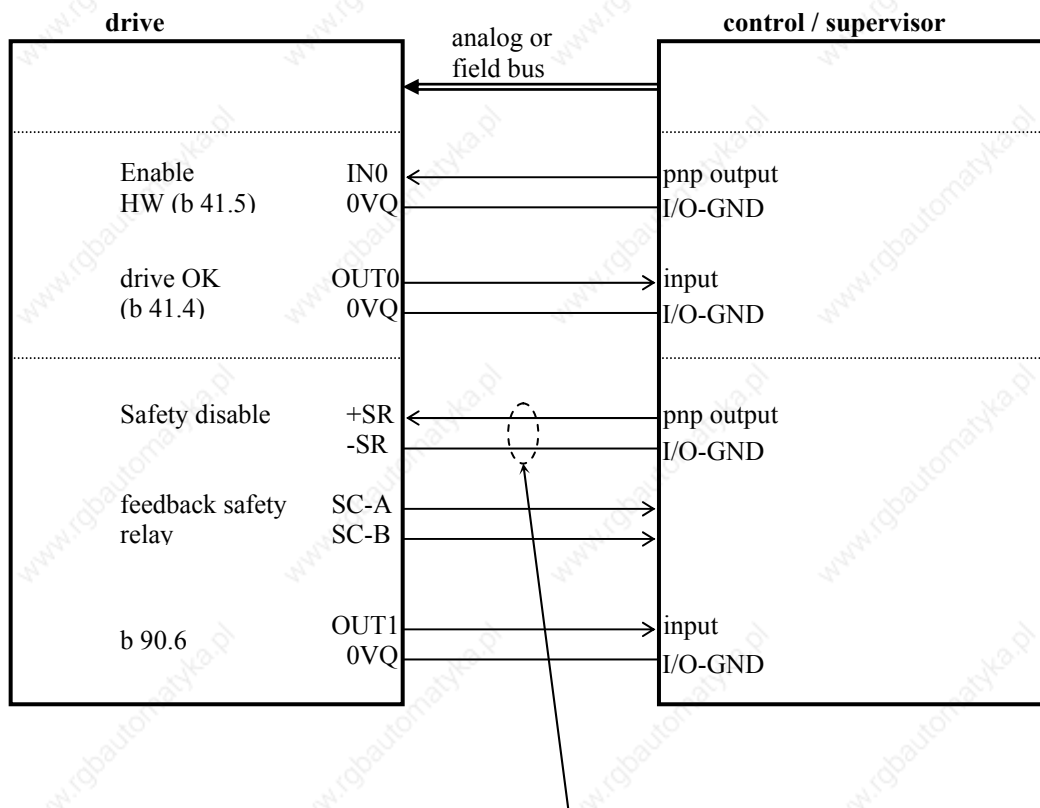

The risk of a short circuit between the safe disable wiring (-SR/+SR) and the 24V supply must be minimized. Segregate the wiring in a dedicated raceway or use a shielded wire with grounded shield.

17.5 Operation, sequence and timing

Follow the below stated sequence :

1. Stop all the motors in a controlled way (zero speed).
2. In case of vertical axes, activate the stationary brake against falling.
3. Disable the drives (b41.5=0 or b40.9=0) and verify that b41.12=0 for both axes.
4. Activate the safe disable function by removing voltage at the input -SR/+SR
5. Verify the hardware feedback SC-A/SC-B and the software feedback b90.6
The clean contact SC-A/SC-B must be found close and the parameter b90.6=0 on both axes.

At this time, the category 3 safety standstill has been achieved without motor-side contactors.

The inverse sequence brings the drive to the standard operating condition.

The timing is as follows :

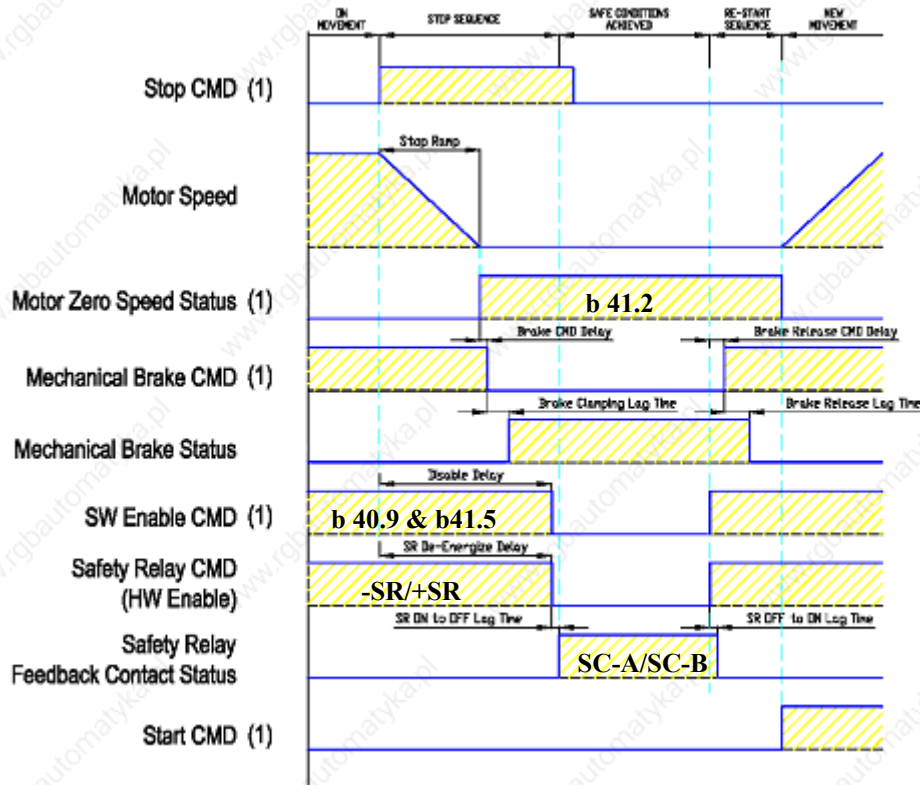

(1) logic signals exchanged between drives and control/supervisor.

Warning :

in case of alarm (see appendix Alarms) during operation, the drive is automatically disabled. Therefore the capability of stopping the motor in a controlled way is lost. The motor will stop with its natural dynamic depending on the total inertia, friction and load torque. The same happens if the safe disable function is activated before the motor has been stopped in a controlled way.

17.6 Example

The following diagram shows an example of safety disable and it is a general reference. Every specific configuration of the machine must be verified in relation to the application.

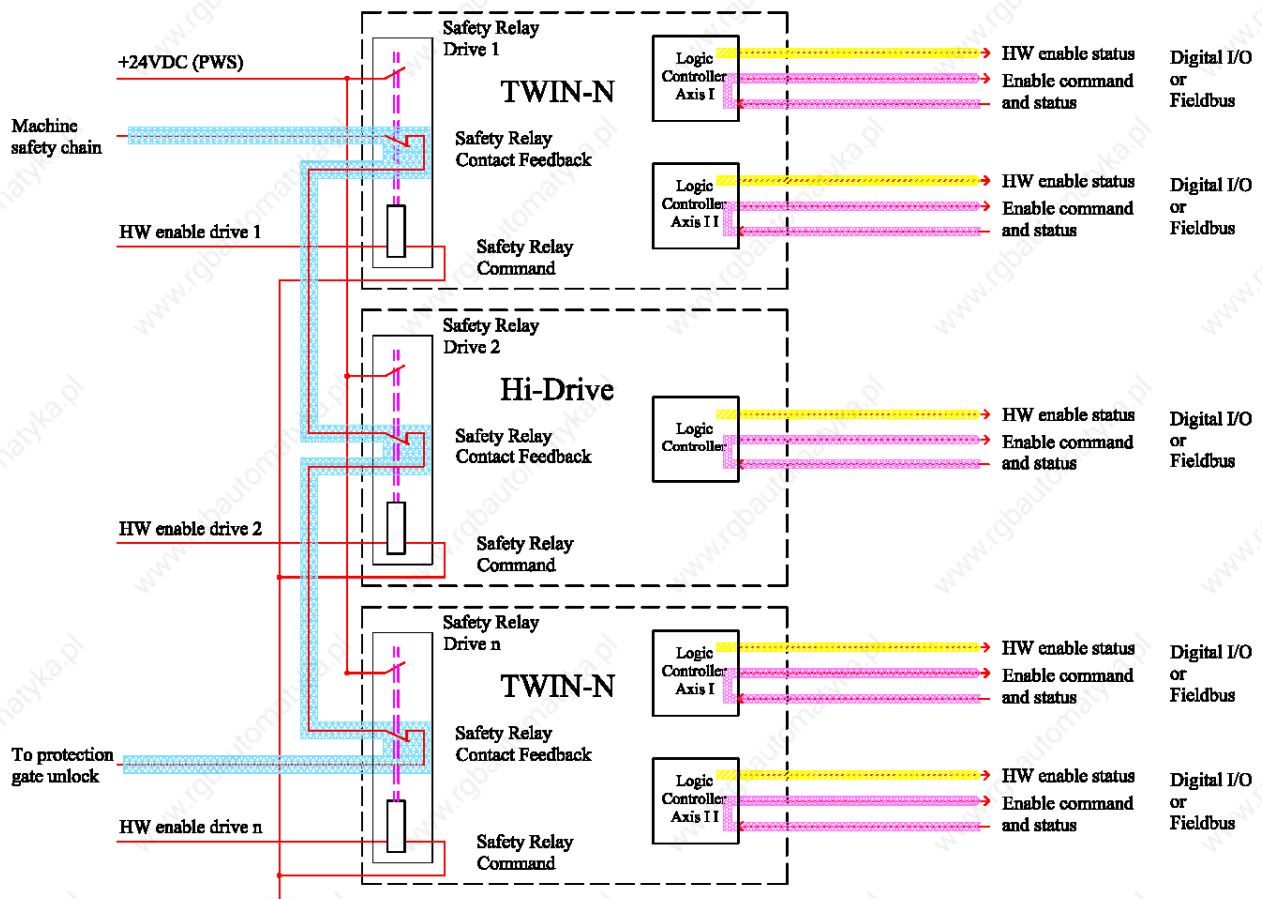

17.7 Test and maintenance

The user must carry out a periodical functional test for the whole safety systems of the machine/application. The functionality must specifically be verified at commissioning, after any kind of maintenance operation on the machine (wiring, replacement of parts etc...) and before any potentially dangerous circumstance for personnel (need to access machine dangerous zones).

It must be verified that, using the safe disable function on each single drive unit, it is impossible to move/rotate all the motors included in the machine safety system, and that this safe standstill state is correctly detected through the feedback system from the drive unit (both hardware feedback SC-A/SC-B and software feedback b90.6).

18 Revision history of the User Manual

- Rev 0 First edition
- Rev 0.1 General adjournments of TWIN-N
Insert SPD-N
Insert safety relay
- Rev 0.2
CANopen DS402
- Rev 0.3
Adjourned FBK connections
Option "R": corrected the par. 5
- Rev 0.4
SPD16N
b40.11
object 0x2063
b272.1 (unit of conversion)

For other informations log into website www.sbcelettronica.com. Arranges to the manual data can be made by the manufacturer without advance notice. The data shown in the manual correspond to the specifications relating to the revision date

Sales Offices

Australia

Parker Hannifin
Pty Ltd
9 Carrington Road
Private Bag 4, Castle Hill
NSW 1765
Tel: +61 2 9634 7777
Fax: +61 2 9899 6184

Belgium

Parker Hannifin SA NV
Parc Industriel Sud Zone 11
23, Rue du Bosquet
Nivelles B -1400 Belgium
Tel: +32 67 280 900
Fax: +32 67 280 999

Brasil

Parker Hannifin Ind. e Com. Ltda.
Av. Lucas Nogueira Garcez, 2181
Esperança - Caixa Postal 148
Tel: +55 0800 7275374
Fax: +55 12 3954 5262

Canada

Parker Motion and Control
160 Chisholm Drive
Milton
Ontario L9T 3G9
Tel: +1(905) 693 3000
Fax: +1(905) 876 1958

China

Parker Hannifin Motion & Control
(Shanghai)
Co. Ltd.
SSD Drives
280 Yunqiao Road
Export Processing Zone
Pudong District
Shanghai 201206
P.R.China
Tel: +86 (21) 5031 2525
Fax: +86 (21) 5854 7599

France

Parker SSD Parvex
8 Avenue du Lac
B.P. 249
F-21007 Dijon Cedex
Tel: +33 (0) 3 80 42 41 40
Fax: +33 (0) 3 80 42 41 23

Germany

Parker Hannifin GmbH
Von-Humboldt-Strasse 10
64646 Heppenheim
Germany
Tel: +49(0) 6252 798200
Fax: +49(0) 6252 798205

India

SSD Drives India Pvt Ltd
151 Developed Plots Estate
Perungudi,
Chennai, 600 096, India
Tel: +91 44 43910799
Fax: +91 44 43910700

Italy

Parker Hannifin SPA
Via Gounod 1
20092 Cinisello Balsamo
Milano
Italy
Tel: +39 (02) 361081
Fax: +39 (02) 36108400

Singapore

Parker Hannifin Singapore Pte Ltd
11, Fourth Chin Bee Rd
Singapore 619702
Tel: +65 6887 6300
Fax: +65 6265 5125

Spain

Parker Hannifin (Espana) S.A.
Parque Industrial Las Monjas
Calle de las Estaciones 8
28850 Torrejonde Ardoz
Madrid
Spain
Tel: +34 91 6757300
Fax: +34 91 6757711

Sweden

Parker Hannifin AB
Montörgatan 7
SE-302 60 Halmstad
Sweden
Tel: +46 (35) 177300
Fax: +46 (35) 108407

UK

Parker Hannifin Ltd.
Tachbrook Park Drive
Tachbrook Park
Warwick
CV34 6TU
Tel: +44 (0) 1926 317970
Fax: +44 (0) 1926 317980

USA

Parker Hannifin Corp.
SSD Drives Division
9225 Forsyth Park Drive
Charlotte
North Carolina 28273-3884
Tel: +1 (704) 588 3246
Fax: +1 (704) 588-3249

Your local authorized Parker distributor

© 2009 Parker Hannifin Corporation. All rights reserved

Parker Hannifin SpA SSD SBC

Via C. Gounod, 1
20092 Cinisello Balsamo (MI)
Tel: +39 02 36108.1
Fax: +39 02 36108400
www.parker.com
info.it.ssd@parker.com
infosbc@parker.com

